



Adjacent Construction Manual

Infrastructure Division

*Prepared by
Structural Engineering*

*Revision 01
March 2022*



(This page intentionally left blank.)



Approved by: James Harper Date: 4/18/2022
Chief Engineer
James Harper

Approved by: William Polacek Date: 4/19/2022
General Manager, Construction
William Polacek

Approved by: TaNesheha Marshall Date: 4/19/22
Vice President, Construction
TaNesheha Marshall

Approved by: **William Mooney** Digitally signed by William Mooney
Date: 2022.04.15 16:10:40 -05'00' Date: 4/15/22
Chief Infrastructure Officer
William R. Mooney



(This page intentionally left blank.)



REVISION SUMMARY

The following provide highlight of changes to major updates in Revision 1 of Adjacent Construction Manual.

SECTION 1: INTRODUCTION

- (1) Manual update cycle added.
- (2) Basic Safety Envelope definition updated.
- (3) Add various new definitions related to rail operations and flagging.
- (4) CTA nearby construction website link updated.

SECTION 2: COORDINATION FLOWCHART AND SUBMITTAL REQUIREMENTS

- (1) Section 2.7 Construction Process Plan (CPP) requirements updated.
- (2) Section 2.8 Construction Verification new requirements added.

SECTION 3: BASIC CONSTRUCTION AND EXCAVATION REQUIREMENTS

- (1) Section 3 name revised and updated to ensure this section governs the overall construction requirements.
- (2) Various underground utility location assumptions, field verifications requirements added.
- (3) Guidelines added for construction impacting CTA Rail Operation related to flagging, slow zone, and line cuts, etc.
- (4) Construction equipment requirements added in Section 3.9.1.
- (5) Handrails and walkways requirements added in Section 3.11.

SECTION 4: OWNER/CONTRACTOR-DESIGNED TEMPORARY SHORING REQUIREMENT

- (1) The use of various shoring types redefined in Section 4.2 and Section 4.3.
- (2) New Jack and Bore Construction requirements added in Section 4.4.
- (3) New Horizontal Directional Drilling Construction requirements added in Section 4.5.

SECTION 5: LOADING ON TEMPORARY SHORING SYSTEM

- (1) No major changes in this section.

SECTION 6: RAPID TRANSIT LIVE LOAD SURCHARGE

- (1) Added Variance Request for existing CTA retaining wall stability check when factor of safety against overturning and sliding cannot achieve as required in Section 7.

SECTION 7: SHORING ANALYSIS METHODOLOGIES

- (1) Added requirements about welding.

SECTION 8: MATERIAL PROPERTIES AND ALLOWABLE STRESSES

- (1) No major changes in this section.



SECTION 9: SPECIAL CONDITIONS

- (1) Minor updates and clarifications regarding dewatering.
- (2) Clarifications added for global stability in Section 9.4.

SECTION 10: TRACK, STRUCTURE, AND SHORING MONITORING

- (1) Added baseline reading requirements for Jack and Bore construction and Horizontal Directional Drilling construction monitoring.
- (2) Supplemental monitoring requirements added for micropile installation within CTA Zone of Influence.

Section 11: OTHER TYPES OF ADJACENT CONSTRUCTION

- (1) Added special requirements for drilled shaft installation.
- (2) Added special requirements for micropile installation.
- (3) Added swing stage requirements.
- (4) Added small unmanned aircraft system requirements.
- (5) Added requirements on miscellaneous elements mounted on CTA elevated track structures.
- (6) Section 11.5 restructured to Existing CTA Facilities.

Appendix A – SUBMITTAL CHECKLISTS

- (1) Various new checklists added.

Appendix B to Appendix H:

- (1) No major changes.



REVISION GUIDE



In an effort to ensure a clean final version is released, the “track-change” feature is turned off. However, different types of revision marks have been developed to assist users understanding what type of changes have been made in the course of reading the new version of ACM.

Deletion: This revision mark is only shown when deletion occurred without any other changes.

Track-Change On No Revision Mark	<ul style="list-style-type: none"> Chicago Transit Authority (CTA) Documents, latest edition: <ul style="list-style-type: none"> CTA Requirements for Contractors Working Along the Right-of-Way (R.O.W.) CTA Safety Manual <u>Specification for working near the ROW</u> CTA Roadway Worker Protection Manual
Track-Change Off Revision Mark Shown in the Final Version	<ul style="list-style-type: none"> Chicago Transit Authority (CTA) Documents, latest edition: <ul style="list-style-type: none"> CTA Requirements for Contractors Working Along the Right-of-Way (R.O.W.) CTA Safety Manual CTA Roadway Worker Protection Manual



Insertion: This revision mark is only shown when insertion of new content occurred and the new content is underlined with dotted line.

Track-Change On No Revision Mark	<p>3.1 ZONE OF INFLUENCE</p> <p>The Zone of Influence is defined in Figure 3 - 1. The area below the influence line is divided into four (4) zones. Requirements and limitations for excavation and temporary excavation support systems within each zone are described in detail below. Excavation requirements apply on or off of CTA Right-of-Way. Excavation beyond the Zone of Influence shall satisfy OSHA and other applicable requirements per the governing jurisdiction.</p> <p><u>When designing ERS for underground utility works, O/C/A/E shall assume the proposed utility alignment is 2 feet deeper, and 2 feet closer towards the CTA tracks, or towards the CTA underground utilities for jack-and-bore and horizontal directional drilling work.³</u></p> <p> ZONE 1</p> <ul style="list-style-type: none"> Excavation is prohibited. Casing/carrier pipe allowed where shown.
Track-Change Off Revision Mark Shown in the Final Version	<p>3.1 ZONE OF INFLUENCE</p> <p>The Zone of Influence is defined in Figure 3 - 1. The area below the influence line is divided into four (4) zones. Requirements and limitations for excavation and temporary excavation support systems within each zone are described in detail below. Excavation requirements apply on or off of CTA Right-of-Way. Excavation beyond the Zone of Influence shall satisfy OSHA and other applicable requirements per the governing jurisdiction.</p> <p><u>When designing ERS for underground utility works, O/C/A/E shall assume the proposed utility alignment is 2 feet deeper, and 2 feet closer towards the CTA tracks, or towards the CTA underground utilities for jack-and-bore and horizontal directional drilling work.³</u></p> <p> ZONE 1</p> <ul style="list-style-type: none"> Excavation is prohibited. Casing/carrier pipe allowed where shown.





Revised Content: This revision mark applies when there are content changes occurred within a paragraph, and the revised content is underlined with dotted line.

Track-Change On No Revision Mark	<p>1.3 CHANGES, UPDATES, AND EFFECTIVE DATE</p> <p>This Manual as well as referenced CTA Documents, such as CTA's safety manual, specifications and design criteria, listed in Section 1.4 are available on the CTA web site: http://www.transitchicago.com/adjacentconstruction/ or will be provided upon request. <u>The maximum duration between this Manual's revision update cycle is 3-years.</u> CTA reserves the right to revise and update this Manual at any time. The most recent date shown on the cover sheet and the lower right-hand footer of each page is the effective date of the Manual. CTA may also issue Memoranda advising Adjacent Construction O/C/A/E on Manual changes prior to incorporating these changes into this Manual. The most recent effective date shall supersede all previous versions, and the most recent Memoranda shall supersede their corresponding Sections in this Manual. If there is a situation where CTA revises and updates the Manual during the review of an Adjacent Construction Project, CTA reserves the right to request the responsible parties to update their submittals with the latest revision of the Manual. Revisions</p>
Track-Change Off Revision Mark Shown in the Final Version	<p>1.3 CHANGES, UPDATES, AND EFFECTIVE DATE</p> <p>This Manual as well as referenced CTA Documents, such as CTA's safety manual, specifications and design criteria, listed in Section 1.4 are available on the CTA web site: http://www.transitchicago.com/adjacentconstruction/ or will be provided upon request. <u>The maximum duration between this Manual's revision update cycle is 3-years.</u> CTA reserves the right to revise and update this Manual at any time. The most recent date shown on the cover sheet and the lower right-hand footer of each page is the effective date of the Manual. CTA may also issue Memoranda advising Adjacent Construction O/C/A/E on Manual changes prior to incorporating these changes into this Manual. The most recent effective date shall supersede all previous versions, and the most recent Memoranda shall supersede their corresponding Sections in this Manual. If there is a situation where CTA revises and updates the Manual during the review of an Adjacent Construction Project, CTA reserves the right to request the responsible parties to update their submittals with the latest revision of the Manual. Revisions</p>



Exceptions:

1. Footnote number sequential changes due to inserting a new footnote was not marked with revision marks.



TABLE OF CONTENTS

TABLE OF CONTENTS 9

TABLE OF FIGURES.....15

OPEN LETTER TO OWNER OF PROPOSED CONSTRUCTION ADJACENT TO CTA
INFRASTRUCTURE17

DIAGRAM CASES FOR ADJACENT CONSTRUCTION WORK.....19

CASE 1 – ELEVATED TRACK STRUCTURES.....19

CASE 2 – ON-GRADE AND RETAINING WALL TRACKS20

CASE 3 – UNDERGROUND STRUCTURES, STATIONS, AND AUXILIARY STRUCTURES ..21

REFERENCE TABLE BASED ON TYPE OF WORK23

SECTION 1 INTRODUCTION.....25

 1.1 PURPOSE25

 1.2 LIMITATIONS, RESPONSIBILITIES AND DISCLAIMERS.....25

 1.3 CHANGES, UPDATES, AND EFFECTIVE DATE26

 1.4 REFERENCES27

 1.5 DEFINITIONS.....28

 1.6 ACRONYMS.....34

SECTION 2 COORDINATION FLOWCHART AND SUBMITTAL REQUIREMENTS35

 2.1 GENERAL37

 2.2 EXCEPTIONS, WAIVERS, AND VARIANCES.....38

 2.3 DRAWINGS.....39

 2.4 CALCULATIONS40

 2.5 DESIGN CHECKLIST40

 2.6 PROPRIETARY SYSTEMS41

 2.7 CONSTRUCTION PROCESS PLAN (CPP)41

 2.8 CONSTRUCTION VERIFICATION44

SECTION 3 BASIC EXCAVATION REQUIREMENTS47

 3.1 ZONE OF INFLUENCE.....47



3.2	VARIANCES	50
3.3	EXCEPTIONS FOR MINOR CONSTRUCTION	50
3.4	RAIL SAFETY TRAINING	50
3.5	RIGHT-OF-WAY	51
3.6	UTILITIES.....	51
3.7	SAFETY REGULATIONS	52
3.8	CONSTRUCTION.....	52
3.9	CONTRACTOR OPERATING RESTRICTIONS	53
3.10	TRACK PROTECTION FENCES	58
3.11	HANDRAILS AND WALKWAYS	58
3.12	CLEARANCES	59
3.13	SHORING REMOVAL.....	59
SECTION 4	TEMPORARY SHORING SYSTEM	61
4.1	OWNER/CONTRACTOR-DESIGNED TEMPORARY SHORING REQUIREMENT.....	61
4.2	PREFERRED SHORING TYPES AND ELEMENTS	61
4.3	PROHIBITED SHORING TYPES AND ELEMENTS	62
4.4	JACK AND BORE CONSTRUCTION.....	63
4.5	HORIZONTAL DIRECTIONAL DRILLING CONSTRUCTION	66
SECTION 5	LOADING ON TEMPORARY SHORING SYSTEM	69
5.1	GENERAL	69
5.2	SOIL LOADS	69
5.2.1	Soil Types and the Determination of Soil Properties	69
5.2.2	Loading from Retained Soil on Flexible Systems	72
5.2.3	Loading from Retained Soil on Restrained Systems	73
5.2.4	Passive Resistance.....	73
5.2.5	Wall Rotation	74
5.3	GROUNDWATER LOAD	74
5.4	SURCHARGE LOADS.....	74
5.5	EARTHQUAKE (SEISMIC) LOAD.....	76
5.6	COMBINATION OF LOADS AND LOADING CASES	76
SECTION 6	RAPID TRANSIT LIVE LOAD SURCHARGE	77
6.1	GENERAL	77
6.2	SURCHARGE FROM MULTIPLE TRACKS.....	78



6.3	SIMPLIFIED SURCHARGE PRESSURE DISTRIBUTION	79
6.4	APPLICATION OF SURCHARGE PRESSURE	79
6.5	SURCHARGE FOR PERPENDICULAR SHORING WALLS IN ZONE 1	79
6.6	COMBINATION WITH SURCHARGE FROM OTHER SOURCES	80
SECTION 7 SHORING ANALYSIS METHODOLOGIES		81
7.1	CONTINUOUS SHORING WALLS	81
7.2	SOLDIER PILE SHORING WALLS	81
7.3	ANALYSIS OF CANTILEVER WALLS	82
7.4	ANALYSIS OF WALLS WITH A SINGLE LEVEL OF BRACING	83
7.4.1	Free Earth Support Method	83
7.4.2	Fixed Earth Support Method	84
7.4.3	Factor of Safety for Shoring Wall Embedment Depth	84
7.5	ANALYSIS OF WALLS WITH MULTIPLE LEVELS OF BRACING	84
7.5.1	Embedment Depth	84
7.5.2	Analysis of Shoring Wall	85
7.5.3	Determination of Bracing Loads	85
7.6	ANALYSIS BRACING SYSTEMS	85
7.7	LAGGING ANALYSIS	86
7.8	GENERAL SHORING REQUIREMENTS	86
7.8.1	Minimum Embedment Depth	86
7.8.2	Secondary Bracing	86
7.8.3	Connections	86
7.8.4	Stiffeners	87
7.8.5	Splices	87
7.9	SHORING DEFLECTION AND SETTLEMENT	87
SECTION 8 MATERIAL PROPERTIES AND ALLOWABLE STRESSES		89
8.1	STEEL	89
8.1.1	Structural Steel	89
8.1.2	Steel Sheet Piling	90
8.1.3	Prestressed Strand or Rod	91
8.1.4	Wire Rope Cable and Chain	91
8.1.5	Casing Pipe	91
8.1.6	Micropile Casing Pipe	91



8.2	CONCRETE.....	92
8.2.1	Non-Shrink Grout.....	92
8.3	WOOD.....	92
8.4	OTHER MATERIALS.....	93
SECTION 9	SPECIAL CONDITIONS.....	95
9.1	SEALED SHORING.....	95
9.2	DEWATERING.....	95
9.3	BOTTOM STABILITY.....	96
9.3.1	Piping.....	96
9.3.2	Bottom Heave.....	97
9.4	GLOBAL STABILITY.....	97
9.5	TIEBACKS.....	97
9.6	DEADMEN.....	99
9.7	MICROPILES.....	99
SECTION 10	TRACK, STRUCTURE, AND SHORING MONITORING.....	101
10.1	PURPOSE.....	101
10.2	LIMITATION ON TRACK MOVEMENT.....	101
10.3	MINIMUM MONITORING REQUIREMENTS.....	102
10.4	SUPPLEMENTAL MONITORING.....	104
10.5	SPECIAL MONITORING.....	106
10.6	ACCESS AND FLAGGING.....	106
SECTION 11	OTHER TYPES OF ADJACENT CONSTRUCTION.....	107
11.1	CONSTRUCTION ADJACENT TO CTA UNDERGROUND STRUCTURES.....	107
11.1.1	General.....	107
11.1.2	CTA Underground Structure Zone of Influence.....	108
11.1.3	Tunnel Analysis Criteria.....	110
11.1.4	Drilled, Augered, Driven and Vibrated Penetration Construction Protocol.....	111
11.1.5	Heavy Vehicles/Equipment Above CTA Underground Structures and Structures	116
11.2	CONSTRUCTION ABOVE AND ADJACENT TO CTA TRACK AND FACILITIES.....	116
11.2.1	General.....	116
11.2.2	Pier/Foundation Wall Protection Adjacent to CTA Tracks.....	116
11.2.3	Pier/Foundation Wall Formwork.....	117



11.2.4	Overhead Wire Line Crossings	117
11.2.5	Bridge Girder Erection Over CTA Tracks	120
11.2.6	Miscellaneous Temporary Structure Adjacent to CTA Tracks	121
11.2.7	Tower Crane Over CTA Tracks.....	121
11.3	CONSTRUCTION ADJACENT TO CTA ELEVATED TRACK AND OTHER STRUCTURES.....	121
11.3.1	Excavation Shoring NOT Required	122
11.3.2	Excavation Shoring Required.....	122
11.3.3	Deep Foundations	124
11.3.4	Wireline Mounted on Elevated Track Structures	124
11.3.5	Miscellaneous Elements Mounted on Elevated Track Structures	124
11.4	ELEVATED TRACK STRUCTURE TEMPORARY SHORING.....	125
11.5	CTA VENT SHAFT PROTECTION OR RECONSTRUCTION.....	127
APPENDIX A – SUBMITTAL CHECKLISTS		129
APPENDIX B – CTA STANDARD TRAIN ENVELOPE CLEARANCE		161
APPENDIX C – SAMPLE CALCULATIONS.....		163
EXAMPLE 4.1 – BENDING STRENGTH OF THREADED MICROPILE CONNECTIONS		163
EXAMPLE 5.1 – DEVELOP AN ACTIVE SOIL PRESSURE DIAGRAM		169
EXAMPLE 5.2 – DEVELOP AN APPARENT SOIL PRESSURE DIAGRAM.....		171
EXAMPLE 5.3 – DETERMINE PASSIVE RESISTANCE (COHESIONLESS SOIL).....		172
EXAMPLE 5.4 – DETERMINE PASSIVE RESISTANCE (COHESIVE SOIL)		176
EXAMPLE 6.1 – RAPID TRANSIT LIVE LOAD SURCHARGE FROM TWO TRACKS.....		177
EXAMPLE 6.2 – RAPID TRANSIT LIVE LOAD SURCHARGE FROM THREE TRACKS		179
EXAMPLE 6.3 – “SIMPLIFIED” RAPID TRANSIT LIVE LOAD SURCHARGE		181
EXAMPLE 6.4 – CONSTRUCT THE ACTUAL RAPID TRANSIT SURCHARGE PRESSURE		183
EXAMPLE 7.1 – CANTILEVER SOLDIER PILE AND LAGGING SHORING WALL.....		186
EXAMPLE 7.2 – SHEET PILE SHORING WALL WITH ONE LEVEL OF BRACING (FREE EARTH SUPPORT METHOD).....		192
EXAMPLE 7.3 – SHEET PILE SHORING WALL WITH ONE LEVEL OF BRACING (FIXED EARTH SUPPORT METHOD).....		192
EXAMPLE 7.4 – ANALYSIS OF A DIAPHRAGM SHORING WALL WITH THREE LEVELS OF BRACING.....		192



EXAMPLE 8.1 – WIDE FLANGE WALER DESIGN	193
EXAMPLE 8.2 – PIPE STRUT DESIGN	195
EXAMPLE 8.3 – SHORING WALL DESIGN	197
EXAMPLE 8.4 – WOOD LAGGING DESIGN	199
APPENDIX D – TABLE OF MINIMUM WALL THICKNESS FOR STEEL CASING PIPE FOR JACK-AND-BORE CONSTRUCTION	201
APPENDIX E – MONITORING/SURVEY RESULTS REPORTING FORMS	203
APPENDIX F – COMMENTARY	205
SECTION 1 INTRODUCTION COMMENTARY	206
SECTION 2 SUBMITTAL REQUIREMENTS COMMENTARY	206
SECTION 3 BASIC EXCAVATION REQUIREMENTS COMMENTARY	208
SECTION 4 TEMPORARY SHORING SYSTEM COMMENTARY	215
SECTION 5 LOADING ON TEMPORARY SHORING SYSTEM COMMENTARY	217
SECTION 6 RAPID TRANSIT LIVE LOAD SURCHARGE COMMENTARY	219
SECTION 7 SHORING ANALYSIS METHODOLOGIES COMMENTARY	221
SECTION 8 MATERIAL PROPERTIES AND ALLOWABLE STRESSES COMMENTARY	223
SECTION 9 SPECIAL CONDITIONS COMMENTARY	225
SECTION 10 TRACK MONITORING COMMENTARY	226
SECTION 11 OTHER TYPES OF ADJACENT CONSTRUCTION COMMENTARY	227
APPENDIX G – PRE-APPROVED WORK AREA-TRACK SEPARATION FENCE	229
APPENDIX H – VARIANCE REQUEST FORM	233



TABLE OF FIGURES

Figure 3 - 1: Zone of Influence49

Figure 5 - 1: Typical Soil Boring Locations for ERS.....70

Figure 5 - 2: Typical Soil Boring Locations for Open Cut71

Figure 5 - 3: Section A for Open Cut71

Figure 5 - 4: Construction of an Apparent Pressure Diagram72

Figure 5 - 5: Effect of Wall Movement on Wall Pressures.....75

Figure 6 - 1: Pressure Distribution for Strip Load.....77

Figure 7 - 1: Design Curves for Maximum Lateral Wall Movement for Excavations in Soft to Medium Clays (Clough and O'Rourke 1990)88

Figure 10 - 1: Minimum Monitoring Requirements.....105

Figure 11 - 1: Tunnel Alignment in Relation to the Excavation107

Figure 11 - 2: CTA Underground Structure Zone of Influence108

Figure 11 - 3: Overhead Wire Line Crossings Clearance Diagram118

Figure 11 - 4: Elevated Track Structure Footing Zone of Influence.....123

Figure 10 - 1: Minimum Monitoring Requirements.....105



(This page intentionally left blank.)



OPEN LETTER TO OWNER OF PROPOSED CONSTRUCTION ADJACENT TO CTA INFRASTRUCTURE

Dear Owner,

Working adjacent to CTA infrastructure can be challenging. Adjacent, from CTA's perspective, refers to activities occurring in the "Basic Safety Envelope", as defined on page 29. When working inside of the CTA defined Basic Safety envelope, CTA has a variety of requirements enforced by our various stakeholder departments. This manual attempts to consolidate these requirements by either direct incorporation into this document or otherwise referencing their locations. The requirements in this manual are intended to safeguard CTA's infrastructure, and in turn, its employees, passengers, and general public. It is our goal that this manual will ease the planning, design, and construction of your project by comprehensively delineating our requirements; while also guiding CTA staff during review of adjacent work activities. This manual does not address requirements or review processes for adjacent construction that affects CTA Bus Operations solely.

As the Owner of property adjacent to the CTA, you are the entity that hires the team of Architects, Engineers, or Contractors for the proposed work adjacent to CTA infrastructure. The CTA expects you to take the leadership role in ensuring your team's compliance with this Manual, either by owning the responsibility yourself or by delegating it to your team. Depending on how your project team is organized and how you delegate responsibilities, each may be responsible for different issues and it may change from project to project. As such, it is in both of our best interests that you understand the requirements in this Manual and delegate responsibilities appropriately. You will find that by clearly defining roles and responsibilities and communicating them with CTA we will be able to provide you with clear direction, which will in turn allow us to keep your project on schedule. As each project is unique, CTA requirements may vary on a case-by-case basis, but this Manual should be valuable guidance for your project.

The remaining pages of this preface provide quick reference guides for work adjacent to the three most common track conditions, elevated, on-grade and subway, as well as a table that delineates requirements by work activity. Section 2 provides process flowcharts and timelines. All project correspondence should be routed to adjconstruction@transitchicago.com.

We sincerely hope that we are able to provide you not only smooth rides on our transit system, but also on your adjacent construction project.

Sincerely,

Chicago Transit Authority Infrastructure Division



(This page intentionally left blank.)



DIAGRAM CASES FOR ADJACENT CONSTRUCTION WORK

The following three diagrams are provided for the users of this Manual to easily locate the starting point of different types of Adjacent Construction Projects. However, it is the users' responsibility to fully familiarize themselves with this Manual for the coordination processes, design, construction and monitoring requirements. All hatched areas below grade in diagrams define the zone of influence affecting CTA structures and Earth Retention Systems will need to be designed with surcharge loadings from the CTA tracks/structures, or for underground structures. Soil unloading will need to be considered when analyzing the tunnel structures.

CASE 1 – ELEVATED TRACK STRUCTURES

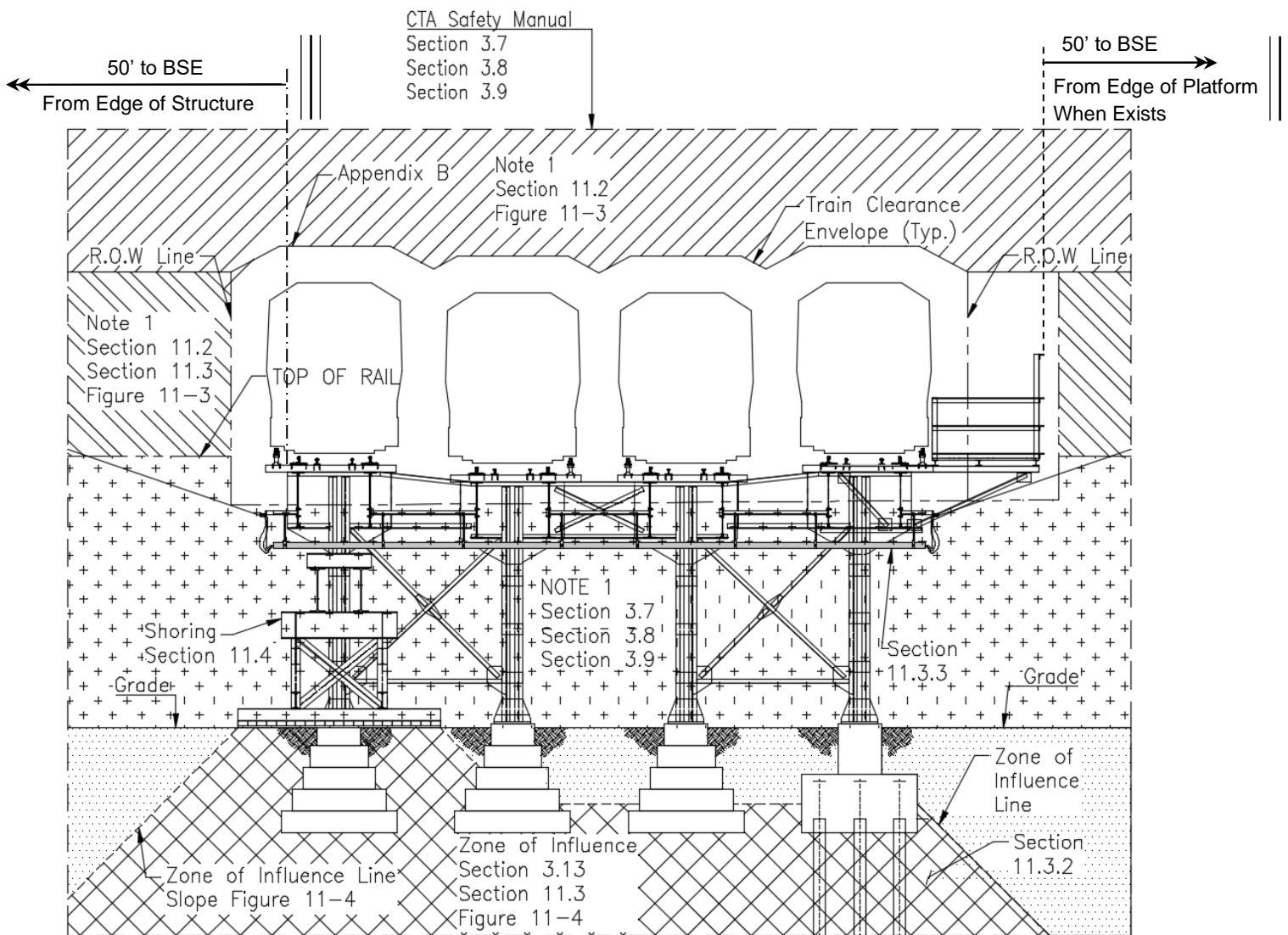

Notes:

1. Consult CTA Safety for requirements. Track flaggers will be required if its determined there is a risk that will extend above tracks. See Sections 3.7, 3.8, and 3.9.



CASE 2 – ON-GRADE AND RETAINING WALL TRACKS

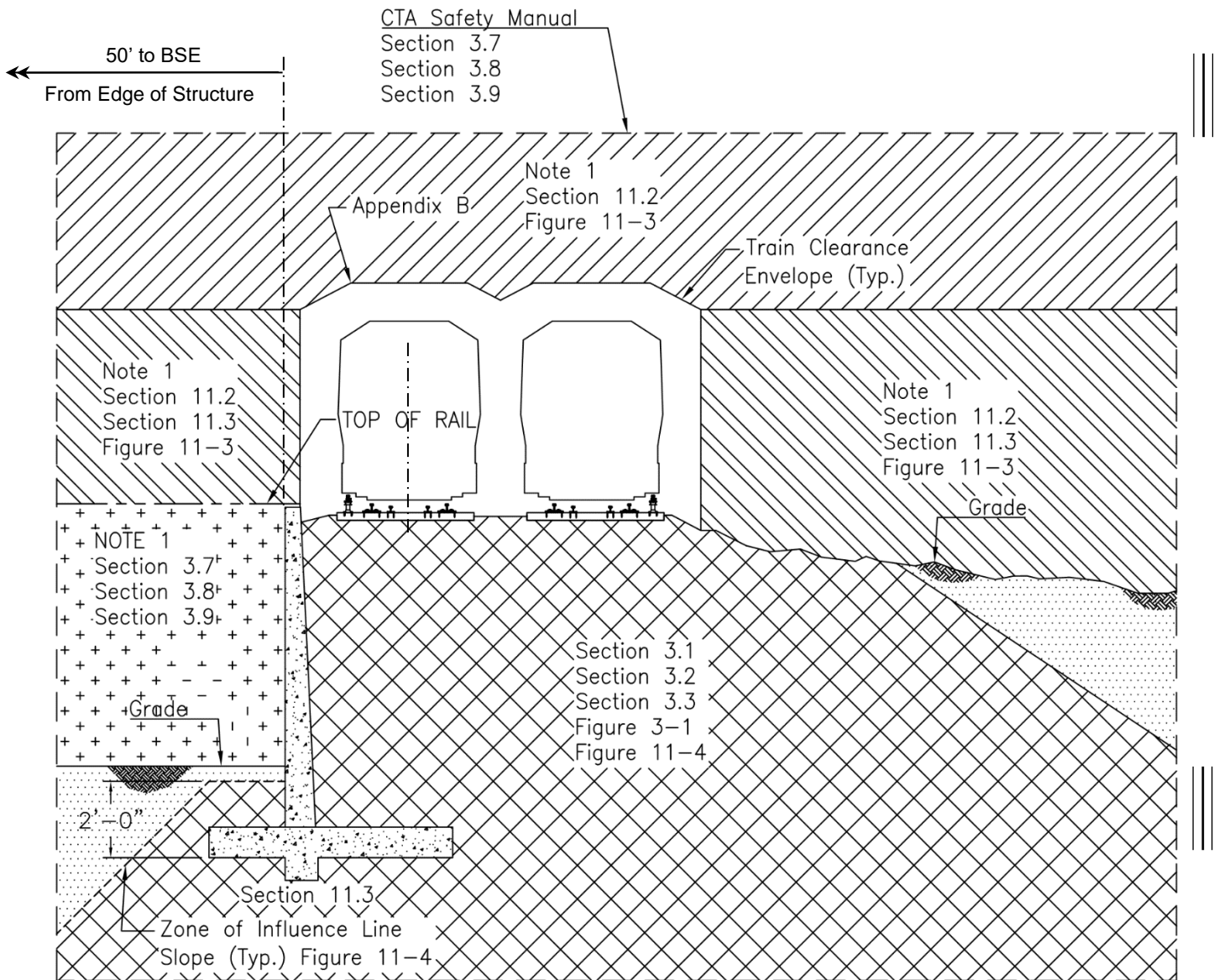

Notes:

1. Consult CTA Safety for requirements. Track flaggers will be required if it is determined there is a risk that will extend into train clearance envelope. See Sections 3.7, 3.8, and 3.9.



CASE 3 – UNDERGROUND STRUCTURES, STATIONS, AND AUXILIARY STRUCTURES

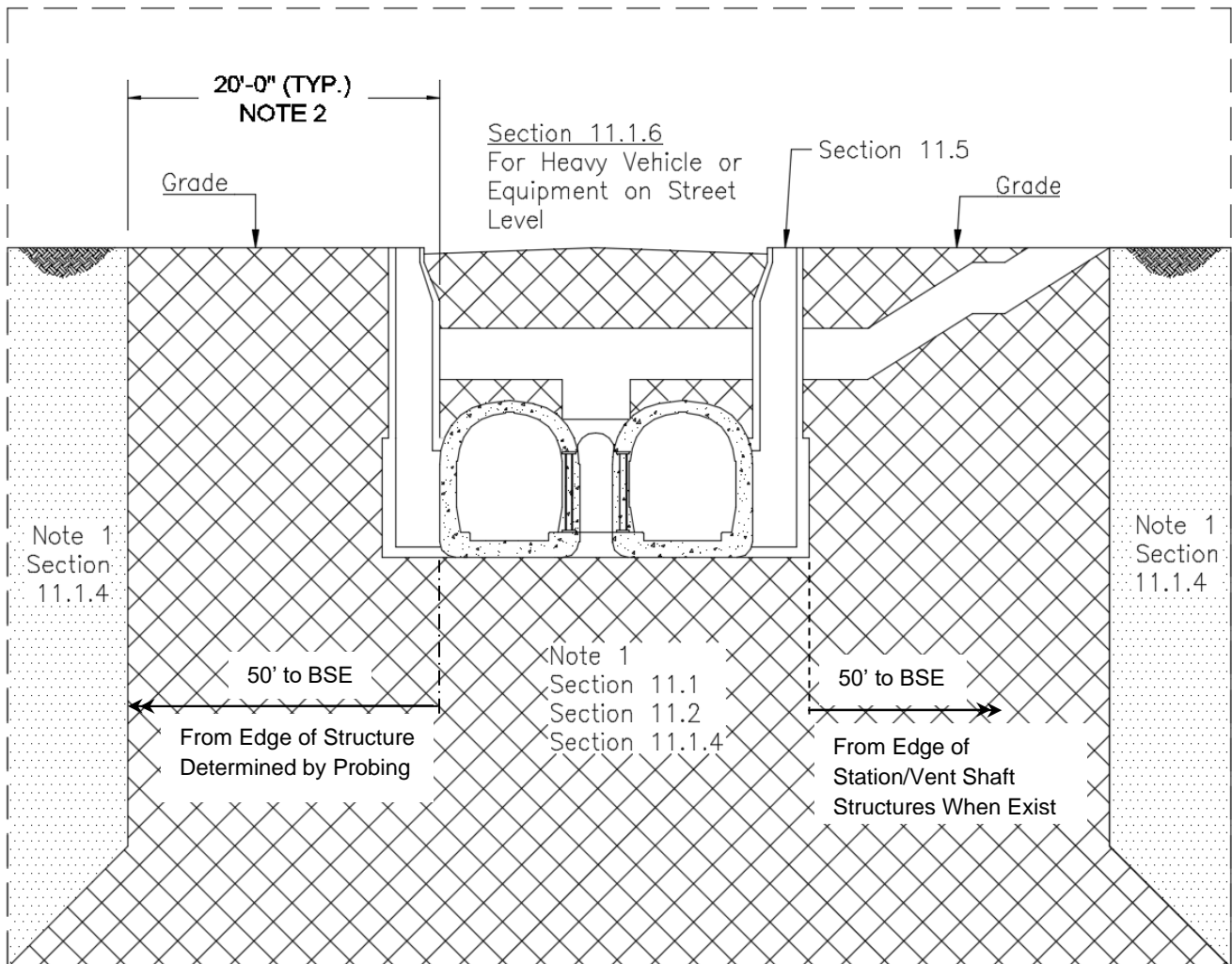

Notes:

1. Consult CTA Safety for requirements. Track flaggers will be required if its determined there is a risk that will extend into train clearance envelop. See Sections 3.7, 3.8, and 3.9.
2. From drilled probe that clears the outer tunnel edge (typical each side).



(This page intentionally left blank.)



REFERENCE TABLE BASED ON TYPE OF WORK

Type of Work	Sections
Soil boring	5.2.1 for soil investigation 5.3 for ground water investigation
Determine right-of-way ownership	3.5
Determine existing utilities	3.6 with additional requirements in 4.4 and 4.5 for Jack-and-Bore Construction
Excavation adjacent to on-grade tracks	3.1 , 3.2
Track protection fences, handrails, and walkways	3.10 , 3.11 , Appendix G
Minor excavation adjacent to on-grade tracks (shallow utilities, poles, etc.)	3.3
Excavation adjacent to subway structures	11.1.1 , 11.1.2 , 11.1.3
Drilled, augered, driven, and vibrated penetration construction adjacent to subway structures	11.1.4
Heavy vehicle or equipment on street level over subway structures	11.1.6
Minor excavation above subway structures (shallow utilities, roadway reconstruction, etc.)	11.1.5
Bridge construction over tracks	11.2.1 , 11.2.2 , 11.2.3 , 11.2.5
Miscellaneous temporary structure adjacent to CTA tracks (scaffold, man lift, etc.)	11.2.6
Tower crane over CTA tracks	11.2.7
Overhead wire line crossings	11.2.4
Wire line crossings mounted on elevated track structure	11.3.4
Miscellaneous element mounted on elevated track structure (lightings, drip pan, etc.)	11.3.5
Excavation adjacent to structure foundations	11.3
Direct shoring of track structures	11.4
Sidewalk reconstruction adjacent to subway vent shaft grating structures	11.5
Jack-and-bore construction	4.4
Directional drilling construction	4.5



Type of Work	Sections
Dewatering	9.2
Testing for tiebacks	9.5
General construction requirements and Contractor operating restrictions	3.8 , 3.9
Track monitoring	10
Shoring removal	3.13
Safety	3.4 and 3.5



SECTION 1 INTRODUCTION

1.1 PURPOSE

The Chicago Transit Authority’s Adjacent Construction Manual (CTA ACM) is prepared in the interest and for the guidance of those who may contemplate construction activities adjacent to, beneath, on, or over existing CTA property, facilities, and/or operating Right-of-Way, also known as the Basic Safety Envelope, as defined on page 25. This Manual provides the minimum requirements for excavations, monitoring, and temporary excavation support. The design of permanent retaining walls and other systems of permanent earth retention adjacent to CTA operating Right-of-Way are addressed in the CTA Infrastructure Design Criteria Manual. All temporary structures anticipated to be in service for more than a one year period are considered permanent structures and may not be entirely governed by this Manual.¹

For CTA projects, this Manual shall also apply to CTA hired Design Consultants and Contractors as modified in the project Specifications.

This Manual outlines the design criteria that must be followed and the process for submitting project information to CTA. It also outlines requirements for constructing a project in the vicinity of, or impacting CTA systems and facilities. As a policy of CTA, projects are reviewed to ensure that no adverse impacts will occur to CTA operations, systems, and facilities and to assure the safe operation of the CTA system. Given the risks associated with construction and excavation adjacent to an active rapid transit track, the design requirements and construction limitations specified herein are conservative and may be more restrictive than those commonly required by other agencies, for example, excavations adjacent to a highway structure. Specialized requirements and recommended design practices for excavation and excavation support contained in this Manual are intended to improve safety of excavation adjacent to active rapid transit tracks for operations, the traveling public, and Contractor personnel and reduce delays and impacts to CTA operations.

For Adjacent Construction projects in the planning and design phase, the flow chart provided in [Section 2](#) provides an overview of tasks to be done and the expected time to complete them in order to receive permission from CTA to proceed with construction activities. **It is recommended that 10 feet clearance be provided for all new development to the adjacent CTA structures to ensure future abilities to inspect and maintain both structures.** Proposed deviations or variances from the provisions of this Manual must be presented to CTA for review following the process given in [Section 2.2](#). CTA’s Chief Engineer has the lead responsibility to review, approve, and oversee implementation for compliance with CTA requirements for all construction adjacent to and/or impacting CTA interests.

1.2 LIMITATIONS, RESPONSIBILITIES AND DISCLAIMERS

This Manual is not intended for use as a textbook, and shall not be used as a substitute for engineering knowledge, experience, or judgment. The criteria, information, and analysis

¹[See Section 1 Commentary](#)



methodologies presented in this Manual have been developed in accordance with recognized engineering principles and in accordance with railroad industry practice. Good design practice will always require a combination of basic engineering principles, experience, and judgment in order to furnish the best possible structure, within reasonable economic limitations, to suit an individual site. **CTA does not warrant the accuracy or completeness of this Manual, nor that this Manual is free from errors and omissions.** Users of this Manual shall independently validate and verify the information contained herein and should promptly notify CTA of any discrepancies or inconsistencies discovered in the course of utilizing this Manual. **Users of this Manual are strongly recommended to read the Commentary section to better understand the intent and concerns of certain requirements in this Manual. Commentary is located in [Appendix F](#).**

Design of temporary shoring systems for excavation support shall be prepared by a licensed Illinois Structural Engineer who shall be solely responsible for verifying the accuracy, suitability, and applicability of the information contained in this Manual for any specific project. The same licensed Illinois Structural Engineer is to field verify the installation complies with the design and provide a letter to CTA confirming as such.

Review and acceptance of submittals by CTA shall not relieve the Contractor and Engineer in Responsible Charge of responsibility for the design and construction of the temporary shoring system, including responsibility for errors and omissions in submittals, and construction deviations from accepted design plans. Excavation safety shall be the responsibility of the Contractor.

CTA is not responsible or liable for any noise and vibration generated which may impact the new structures built adjacent to existing CTA Rapid Transit structures.

For information regarding additional limitations, restrictions, insurance and bond requirements, letter of commitment, deposit requirements, and rail safety training, please refer to the CTA Requirements for Contractors Working Along the Right-of-Way (R.O.W.) document available on the CTA Adjacent Construction web site:

<http://www.transitchicago.com/nearbyconstruction/>

1.3 CHANGES, UPDATES, AND EFFECTIVE DATE

This Manual as well as referenced CTA Documents, such as CTA's safety manual, specifications and design criteria, listed in [Section 1.4](#) are available on the CTA web site: <http://www.transitchicago.com/nearbyconstruction/> or will be provided upon request. The maximum duration between this Manual's revision update cycle is 3-years. CTA reserves the right to revise and update this Manual at any time. The most recent date shown on the cover sheet and the lower right-hand footer of each page is the effective date of the Manual. CTA may also issue Memoranda advising Adjacent Construction O/C/A/E on Manual changes prior to incorporating these changes into this Manual. The most recent effective date shall supersede all previous versions, and the most recent Memoranda shall supersede their corresponding Sections in this Manual. If there is a situation where CTA revises and updates the Manual



during the review of an Adjacent Construction Project, CTA reserves the right to request the responsible parties to update their submittals with the latest revision of the Manual. Revisions and updates to this Manual will be posted on the web site. Users of this Manual shall be solely responsible for checking the web site for updates and utilizing the latest version. Forward any proposed changes or updates to this Manual to the CTA Infrastructure Division for consideration. The Contact information is as followed:

Adjacent Construction Oversight
Attention: Structural Engineering
Email Address: adjconstruction@transitchicago.com

1.4 REFERENCES

The following documents are referenced in this Manual:

- Chicago Transit Authority (CTA) Documents, latest edition:
 - CTA Requirements for Contractors Working Along the Right-of-Way (R.O.W.)
 - CTA Safety Manual
 - CTA Roadway Worker Protection Manual
 - Master CTA Spec for IDOT Projects – CTA Flagging and Coordination
 - Flagman Requirements

- American Railway Engineering and Maintenance-of-Way Association (AREMA), Manual for Railway Engineer, latest edition.

- State of Illinois Department of Transportation (IDOT), Standard Specifications for Road and Bridge Construction, latest edition.

- American Welding Society (AWS), D1.1, Structural Welding Code – Steel, latest edition.

- Federal Highway Administration (FHWA), Geotechnical Engineering Circular No. 4, Ground Anchors and Anchored System, FHWA-IF-99-015, June 1999.

- Federal Highway Administration (FHWA), Geotechnical Engineering Circular No. 7, Soil Nail Walls, FHWA-IF-03-017, March 2003.

- South California Regional Rail Authority (SCRRA) Metrolink Excavation Support Guidelines, July 2009

- “*Trenching and Shoring Manual*” by State of California, Department of Transportation, Issued by Offices of Structure Construction, Copyright © 2011 California Department of Transportation. All rights reserved.



- Massachusetts Bay Transportation Authority Guidelines and Procedures for Construction on MBTA Railroad Property, April 2001.
- United States Steel (USS) Steel Sheet Piling Design Manual, 1984.
- Naval Facilities Engineering Command DM-7.02 Foundations and Earth Structures, September 1986
- NHI Publication No. FHWA-NHI-15-044 Engineering for Structural Stability in Bridge Construction
- 765 ILCS 140 – Adjacent Landowner Excavation Protection Act (Illinois Compiled Statutes)
- Post-Tension Manual by Post Tensioning Institute (PTI)
- Guidelines for the Design of Buried Steel Pipe by American Lifelines Alliance, July 2001 with addenda through February 2005.
- AWPA U1: Use Category System – User Specification for Treated Wood by American Wood Protection Association, latest edition.
- Metra Guidelines for Utility Installations Part 1 – Wire Lines and Communications Cables, September 2007
- ComEd System Standard Clearance for Conductors or Poles to Railroad Tracks and Rail Cars (Reference NESC 2341), December 2014
- Interim Guidelines for Horizontal Directional Drilling (HDD) Under Union Pacific Railroad Right-of-Way
- National Design Specification (NDS) for Wood Construction by American Wood Council

1.5 DEFINITIONS

A. General (Not in alphabetic order)

Shall, must

Terms “shall” and “must” indicate mandatory conditions; the user of this Manual will make every practical effort to follow the criteria. If it is impractical to follow the “shall” or “must” criteria, the user of this Manual needs to obtain CTA approval through Variance Request outlined in [Section 2.2](#) and document the decision made. Lack of



compliance with “shall” or “must” requirements may result in rejection of proposal.

Should Term “should” is an advisory condition; the user of this Manual is recommended, not mandated, to follow the criteria. For situations where it is impractical to follow the “should” criteria, the user of this Manual needs to obtain CTA approval and document the decision made.

May Term “may” is a permissive condition; it is recommended that the user of this Manual make reasonable efforts to follow the design criteria. For situations where it is impractical to follow the “may” criteria, the user of this Manual does not need authorization for design variances.

B. Railroad Terminology

Basic Safety

Envelope (BSE) The area within fifty (50) feet horizontally of edge of track structures or edge of wayside/station platforms, or twenty-five (25) feet outside the property line, whichever is greater. The pair of imaginary lines, which define the outside boundaries of the Basic Safety Envelope, extend vertically up and down infinitely. For the purpose of this Manual, all construction activities within these boundaries will be considered to have the potential to affect the track or CTA operations and will be constrained as necessary by the CTA Employee-in-Charge/Flagger.

Construction Process Plan (CPP)

A program, plan, and schedule prepared, and submitted by the Contractor and accepted by CTA that accurately describes and illustrates the manner in which work within the Basic Safety Envelope will be accomplished, the potential impacts on elements of the Operating System and the manner and methods by which these elements will be protected from any potential impact, and/or the manner in which work will be accomplished.

Contractor The individual, firm, partnership, corporation, joint venture, or combination thereof that has entered into a construction contract with the legal entity for which the work is being performed. For purpose of this Manual, Contractor also includes any sub-contractor, supplier, agent, or other individual entering the CTA Right-of-Way during performance of the work.

CTA InspectorCTA Inspector can include: personnel from Chicago Transit Authority Engineering, Construction, Safety, Rail Operations, etc.



	<u>And CTA hired construction service construction managers (CM) or project managers.</u>
Engineer in Responsible Charge	The Licensed Structural Engineer in responsible charge of structural design as required in this Manual, whose seal and signature shall be affixed to the Drawings, Specifications, calculations, and other documents used in the design and construction. For the purposes of this Manual, the Engineer in Responsible Charge also includes other people designated by the licensed Structural Engineer in responsible charge and working at his/her direction.
<u>Flagger</u>	<u>An employee designated to control the movement of trains by display of hand signals, flags or lights.</u>
<u>Flag Zone</u>	<u>A segment of track with definite boundaries.</u>
<u>Flag Zone Index</u>	<u>A chart identifying each flag zone by the 1) Flag Zone number; 2) location (limits of the Flag Zone); 3) number of tracks; 4) track characteristics/special conditions; 5) rail stations within the Flag Zone; and 6) Flagger Requirements.</u>
<u>Flag Zone Map</u>	<u>A map of areas of a rail line illustrating the limits of Flag Zones.</u>
Line Cut	A temporary cessation of all service on a transit line; meaning total stoppage of transit service on all tracks and at all stations within the closure zone to facilitate access for a Contractor(s) to perform work on or near the CTA Right-of-Way. If CTA or CTA's Contractor(s) request Line Cut operations along the same line concurrently with the Adjacent Construction Contractor, CTA shall have the exclusive authority to determine which request shall be granted.
Manual	For the purpose of this document, Manual shall be considered this document (CTA Adjacent Construction Project Manual) in part or in its entirety. Other documents may be referred to as guidelines and shall not mean this document.
Operating System	Includes, but is not limited to, the tracks on which trains and "on-track" equipment operate or may potentially operate, and in addition any facilities closely related to the operation of the CTA system including, but not limited to, signal, power, communications, bridges, poles, cables and houses, underground structures, culverts, access roads, ramps, highway-rail grade crossings and station platforms.



Public Agency	The federal government and any agencies, departments, or subdivisions thereof; the State of Illinois; and any county, city, city and county district, public authority, joint powers agency, municipal corporation, or any other political subdivision or public corporation therein, responsible for sponsoring a project.
Right-of-Way	A strip of land, real estate, or property of interest, under the ownership or operating jurisdiction of CTA or other Public Agencies on which railroad tracks, other structures, and facilities are constructed.
<u>Service Bulletin</u>	<u>An instructional bulletin that is used for planned irregular train operation – format used for removal of a track from service.</u>
Single-Track	A temporary operation established by operating trains bi-directionally on one track while the adjacent track is taken out-of-service. A Single-Track can only be established between track crossovers in the proper configuration for the required train movements. Only one Single-Track at a time can be set up on a line and only for very limited time periods. If CTA or CTA's Contractors) request single track operations along the same line concurrently with the Adjacent Construction Contractor, CTA shall have the exclusive authority to determine which request shall be granted.
<u>Slow Zone</u>	<u>A series of signs establishing a segment of track where trains must operate at a reduced speed due to workers on the Right-of-Way, track and structure conditions, or other reasons that trains must operate at a reduced speed.</u>
Third Party	An individual, firm, partnership, or corporation, or combination thereof, private, or public, participating, sponsoring, or affected by a project. Government agencies and utilities may be considered a Third Party.
Zone of Influence	The zone within which shored excavation is required and the shoring system is required to be designed for CTA rapid transit and/or railroad live load surcharge. <u>It does not mean open cut is permitted outside the Zone of Influence line.</u> See Figure 3 - 1: Zone of Influence , Figure 11 - 2: CTA Underground Structure Zone of Influence , and Figure 11 - 4: Elevated Track Structure Footing Zone of Influence .

C. Shoring Terminology

Deep Soil Mix Wall	An augured, cement grout soil improvement technique, incorporating soldier reinforcement, whereby in-situ soils are mixed
--------------------	---



in place with cement grout to form a row of overlapped soil-cement columns. These overlapped soil-cement columns are used for both groundwater cutoff and, with soldier piles, as a reinforced-soil diaphragm-type shoring wall.

Diaphragm Wall

A continuous shoring wall comprised of concrete or a mixture of cement soil (usually with embedded vertical steel members) that is drilled or excavated in place prior to excavation in order to support lateral loads from retained soil and water. Examples of diaphragm walls include deep soil mix walls, secant walls, tangent walls, and slurry walls.

Grouting

Injection of fluid materials into the ground to improve the strength of ground, decrease permeability and prevent water inflows, and/or compensate for ground settlements and movements. Types of grouting include permeation grouting (cement, micro-cement, chemical, etc.), jet grouting, and compacting grouting.

Lagging

Timber boards, planking or sheathing, reinforced concrete planks, or steel plate secured between adjacent soldier piles.

Packing

Steel, wood, concrete or non-shrink grout used to fill gaps and transfer load between the shoring wall and bracing elements.

Preloading

Placement of initial loads in bracing members by jacking and shimming or wedging to assure adequate bearing of connected shoring elements and to reduce ground movements.

Secant Wall

A continuous shoring wall formed by a series of overlapped, concrete-filled drilled piers (otherwise commonly referred to as drilled shafts, caissons, or cast-in-drilled-hole [CIDH] piles). A minimum of every other pier is reinforced to span vertically.

Sheet Piling

Vertical steel shapes that are driven into the ground and interlocked with each other to form a continuous wall in order to support lateral loads from retained soil and water.

Shoring Deadman

A buried or partially buried structure that is utilized as an anchorage for tension rods that restrain a shoring wall. Deadman anchorage may be provided by soldier piles, sheet piling, or concrete blocks or walls.

Slurry Wall

Continuous, reinforced concrete wall constructed by filling a series of discrete trenches with tremie concrete. Tremie concrete displaces bentonite or polymer slurry that is in the trench. The slurry is used to prevent collapse of the trench during excavation for slurry wall placement. The resulting concrete barrier wall retains



	soil and ground water on the exterior side of the slurry wall, and permits excavation and removal of soil on the interior side of the wall. Walls may be reinforced or non-reinforced.
Soil Nailing	A system in which soil nails are typically grouted, untensioned rebars that are installed in drilled holes in order to form a reinforced soil mass. Reinforced shotcrete is applied to the face of the excavation. Shotcreting and nail installation proceed in a top down manner as excavation proceeds.
Soldier Piles	Vertical steel shapes (typically wide flange or HP) installed to support lateral loads from retained soil (and water if part of a sealed shoring system).
Strut	A brace (compression member) that resists thrust in the direction of its own length. The connection from a strut to a soldier pile or waler shall not be a single gusset plate. ²
Tangent Wall	A shoring wall formed by a series of concrete-filled drilled piers (otherwise commonly referred to as drilled shafts, caissons, or cast-in-drilled-hole [CIDH] piles) that are installed tangent to each other and do not overlap. A minimum of every other pier is reinforced to span vertically.
Tieback (Soil Anchor)	A tension element utilized to restrain a shoring wall. A tieback consists of a steel tendon (bar or strands) installed in a drilled hole. The tendon is bonded to the soil over its anchorage bond length with cement grout. The tendon is tensioned to provide positive restraint to the shoring wall and to reduce wall deflections.
Tremie Concrete	Concrete deposited under water or slurry by means of tremie equipment. The concrete displaces the water or slurry as the concrete is deposited.
Trench Shield or Or Trench Box	Pre-fabricated structure that is commonly installed to support lateral earth loads for utility installation, and whose walls commonly have no embedment into the soils below excavation subgrade. Trench shields are typically installed within pre-excavated slots and/or pushed into the ground as the excavation proceeds.
Waler	Horizontal beam used to brace vertical excavation shoring elements.

²[See Section 1 Commentary](#)



1.6 ACRONYMS

The following acronyms are used in this document:

ANSI	American National Standards Institute	
AREMA	American Railway Engineering and Maintenance of Way Association	
ASTM	American Society for Testing and Materials	
CADD	Computer-Aided Drafting and Design	
CDOT	Chicago Department of Transportation	
CFR	Code of Federal Regulations	
CPP	Construction Process Plan	
CTA	Chicago Transit Authority	
EFP	Equivalent Fluid Pressure	
FHWA	Federal Highway Administration	
FRA	Federal Railroad Administration	
GPR	Ground Penetrating Radar	
HDD	Horizontal Directional Drilling	
IC	Illinois Central Railroad	
IDOT	Illinois Department of Transportation	
<u>JULIE</u>	<u>Joint Utility Locating Information for Exactors</u>	
LOCID	CTA Location Identifier	
<u>MOM</u>	<u>Ministry of Manpower</u>	
NAVFAC	Naval Facilities Engineering Command	
NHI	National Highway Institute	
O/C/A/E	Owner/Contractor/Architect/Engineer	
OSHA	Occupational Safety and Health Administration	
OUC	Office of Underground Coordination	
QA/QC	Quality Assurance / Quality Control	
R.O.W	Right-of-Way	
SCRRA	South California Regional Rail Authority	
USS	United States Steel	



SECTION 2 COORDINATION FLOWCHART AND SUBMITTAL REQUIREMENTS

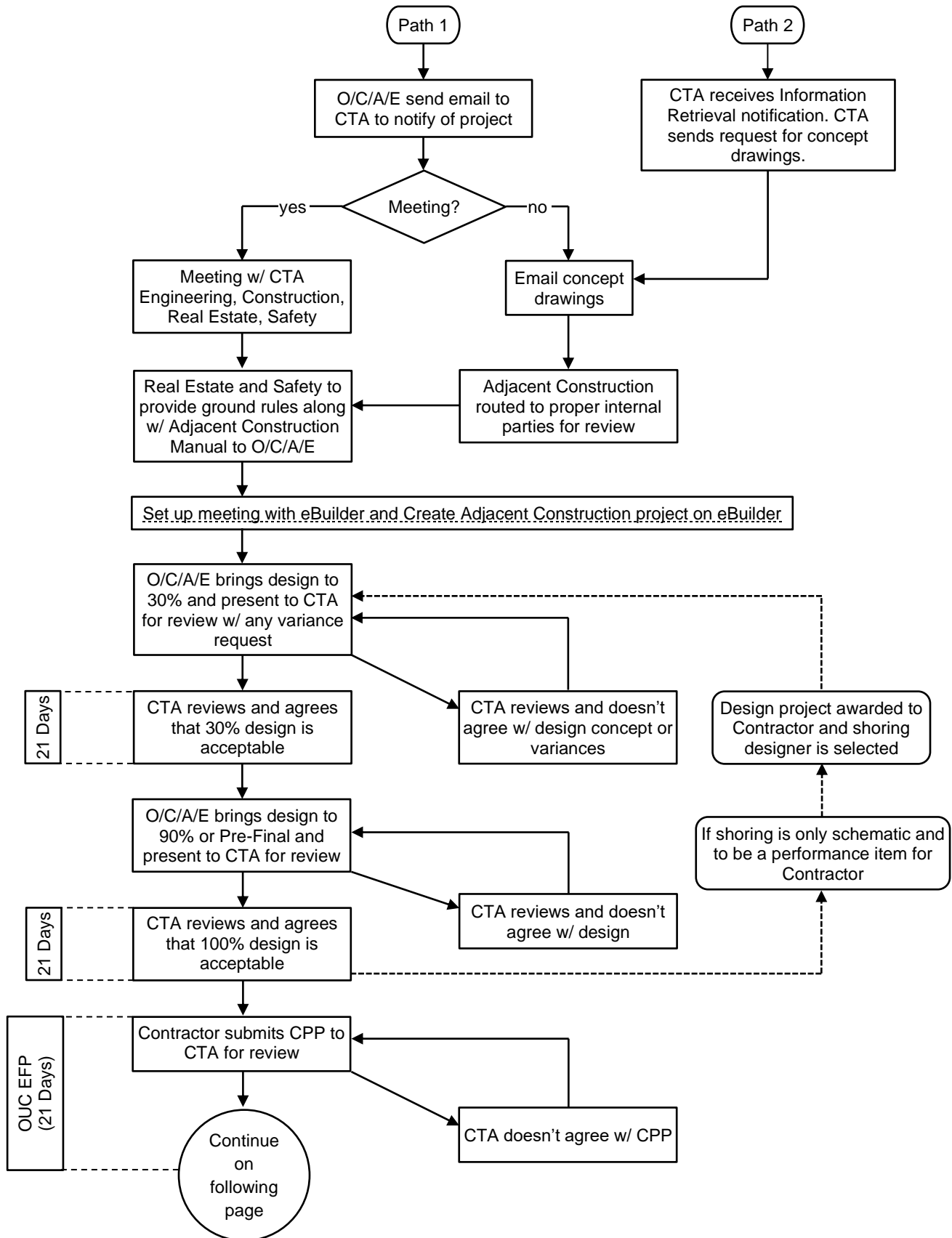



Section 2 – Coordination Flowchart and Submittal Requirements

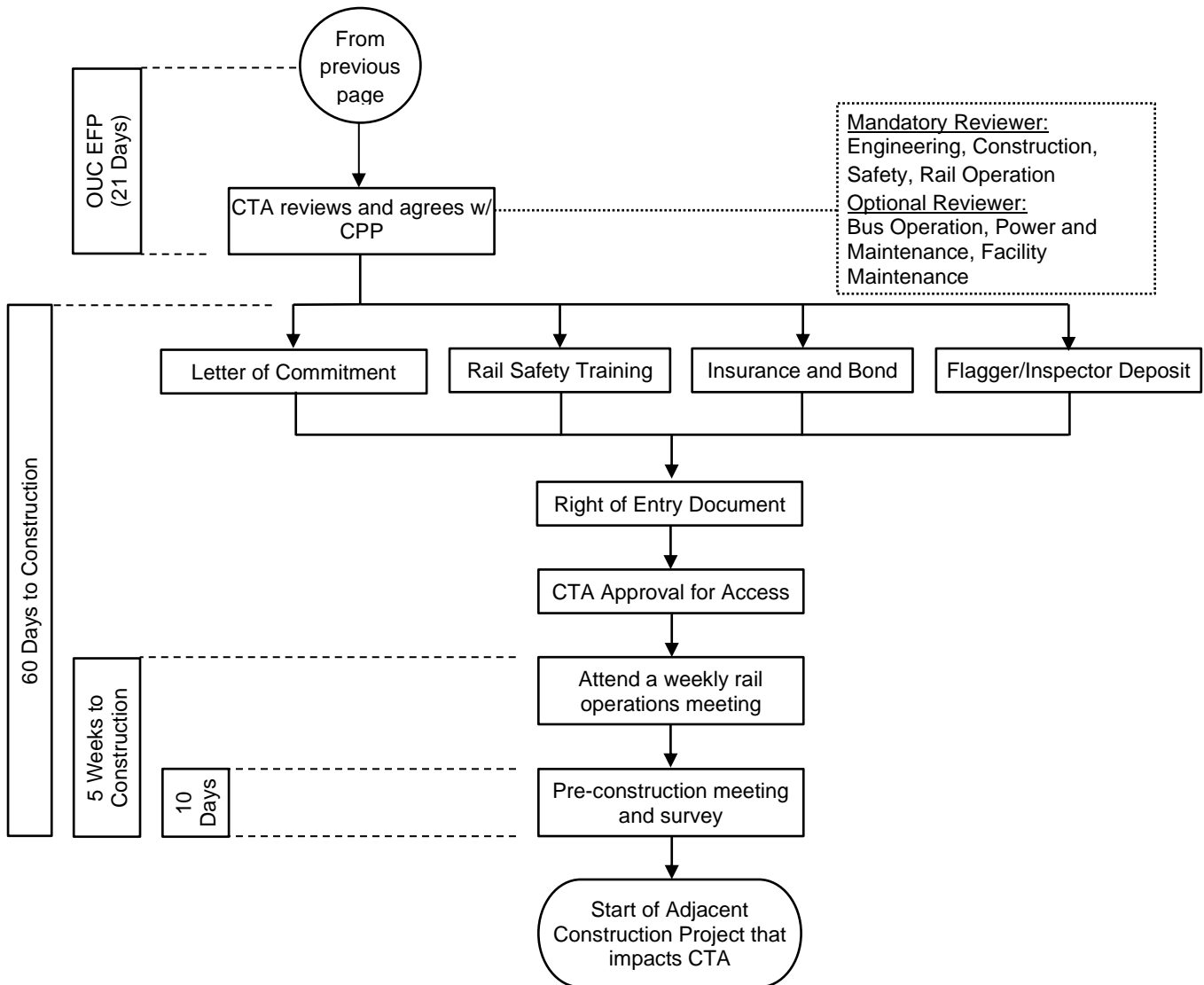

Note:
Items shown in the above flowchart may overlap.



Section 2 – Coordination Flowchart and Submittal Requirements

2.1 GENERAL

All drawings and calculations for the Adjacent Construction Project that impacts CTA shall be prepared, sealed, and signed by a Structural Engineer currently licensed in the State of Illinois who has previous experience in the design of temporary shoring systems of the type being submitted (preferably ten years). Preferably, temporary shoring systems will be designed by a team composed of a railroad structural engineer who is experienced, knowledgeable and competent in design, construction, operations and maintenance parameters for commuter/passenger and freight railroad systems, and a licensed structural engineer who is experienced, knowledgeable and competent in the design and construction of shored excavations adjacent to railroad tracks.

The designer will be responsible for the accuracy of all controlling dimensions as well as the selection of soil design values that accurately reflect the actual field conditions. No shoring installation or excavation within the Zone of Influence will be allowed until the drawings and calculations are reviewed and accepted by CTA. CTA will NOT approve signed and sealed submittals. Accepted submittals are treated as “Received for Record”.

Forms, drawings, and calculations shall be submitted to CTA for review in electronic format transmitted by email, ftp, or mail (with CD-R or DVD-R properly labeled) as means to notify CTA of the Adjacent Construction. After the initial coordination with CTA, a project coordination website will be created by CTA and all submittals and CPP's must be uploaded to the appointed project website. Any documents not uploaded to the project website will not be considered as received by CTA. User Instructions for the project website will be provided by Adjacent Construction team or CTA's Adjacent Construction CM. Files shall be Bluebeam and Adobe PDF compatible. Each separate document shall be a separate PDF file (drawings, specifications, calculations, forms, etc.). Files shall be named using the following guidelines:

- “ADJ” indicating Adjacent Construction;
- A LOCID may be assigned by CTA Engineering after first coordination occurs;
- CTA Project Number (YYYY-NNNNN.NN) - If the project is in design phase, CTA Adjacent Construction will assign a project number and it shall be included in the file name;
- Date submitted
- Document type (DW – drawings; SP – Specifications; CA – Calculations; PP – Construction Process Plan; etc.);
- If the project is under OUC review, there should be an OUC number (OUCID) already assigned. The 8-digit OUCID shall be included in the file name;
- Brief descriptions of the submittal;

A file name example: ADJ_LOCID_YYYY-NNNNN.NN_ YYYYMMDD_ Document type_ OUCID_Description

All submittals, design calculations, specifications and drawings shall be prepared in accordance with a QA/QC process. The QA/QC process may follow the established program of a Public



Section 2 – Coordination Flowchart and Submittal Requirements

Agency, Engineer in Responsible Charge firm, or Contractor. The QA/QC process used shall be made available to CTA at their request.

It is required by CTA Engineering that the QA/QC process consists of an independent check of design calculations and an independent QC review of the drawings and specifications prior to submittal to CTA by qualified individuals. Documentation of the QA/QC process, including names and contact information of independent reviewers, shall be made available to CTA at their request if the independent check and QC review is implemented.

A minimum of twenty-one (21) calendar days should be allowed for CTA's review, provided that all required submittal materials are included and properly identified.

2.2 EXCEPTIONS, WAIVERS, AND VARIANCES

The current practice for all Adjacent Projects in the City of Chicago is for them to be submitted and reviewed under the OUC review process during the construction phase. This can create prolonged review times, impacts to the scope of the Adjacent Construction Projects and many other complications when exceptions, waivers, and/or variances cannot be granted. Given the risks associated with construction and excavation adjacent to an active rapid transit track, it is essential that the Adjacent Project Team familiarize themselves with this Manual and coordinate with CTA in the planning or early design phase.

Any deviations from the requirements outlined in this Manual, and/or any Sections where Variance Request is specifically required, must follow these procedures.

Variance Request Procedure

1. For projects under design, variance requests should be submitted at the Concept or 30% review levels for consideration by CTA after the Adjacent Construction Project is first introduced to CTA through the OUC Information Retrieval Process. Concept level variance requests are preferred. Design should not be advanced prior to receiving a decision on a variance request.
2. Submit the variance request to CTA Adjacent Construction using the Variance Request Form in [Appendix H](#). This should be a separate submittal from any design review submittal. The request should be signed and sealed by the Engineer in Responsible Charge. It is imperative that the following specific information be included on the form or as an attachment:
 - a. Exact location of the proposed work (attach maps and/or figures) and include the following:
 - i. GPS coordinates
 - ii. North arrow
 - b. Identify the exact provision of the Guidelines for which the exception, waiver or variance is requested.
 - c. Complete description of the proposed work



Section 2 – Coordination Flowchart and Submittal Requirements

- d. Proposed limits of excavation, plan area and depth
 - e. Proposed type(s) of shoring including track protection fences, handrails, walkways, or other means of protection for CTA track workers, normal operations, emergency evacuation, and operations personnel working adjacent to track
 - f. Proof of concept drawings and calculations
 - g. Proposed duration for installation and removal of shoring systems
 - h. Proposed duration of shoring system and means for ensuring track is not displaced while system is in place
 - i. Description of alternates that conform to this Manual and brief evaluation to show that any other alternate conforming to this Manual is not practical.
3. CTA will review the request and return a decision within ~~twenty-one (21)~~ calendar days.
 4. If the variance request is accepted by CTA, the applicant agrees to follow all conditions imposed by CTA. For shoring within Zone 2, complete owner-designed shoring, and details per [Section 4.1](#) should be included in the plans at the 90% level. Design conditions and requirements in this Manual for any Contractor-designed alternate shoring system shall be included in the plans and specifications. CPP shall be prepared and submitted by the Contractor during the OUC Existing Facility Protection Process.
 5. For projects already under construction when this Manual is first posted on the web site, CTA's coordination and review will occur during the OUC review process.

2.3 DRAWINGS

The drawings for Adjacent Construction Project that impacts CTA must be complete and shall accurately describe the nature of the work. Drawings shall be to scale.

At a minimum, the drawings shall include the following:

- a. Plan view that includes the following information and meets the following criteria:
 - o GPS coordinates
 - o North arrow
 - o All pertinent topographic information
 - o All Operating System elements and facilities
 - o All overhead and underground utilities
 - o All of the proposed excavations and distances from centerline of the track(s) to the face of the excavation and temporary shoring at relevant locations
 - o Proposed types and locations of equipment used to install the temporary shoring
 - o The drawing shall be in U.S. units with a scale no less than 1" = 10'. Acceptable scales include 1" = 10', 1/8" = 1'-0", and 1/4" = 1'-0".
- b. Section view normal to the track(s) showing the temporary shoring system relative to the centerline of the track(s). The section shall show elevations of the track(s), the existing



Section 2 – Coordination Flowchart and Submittal Requirements

ground surface, excavation lines at each stage as applicable, and bracing elements. Protective dividers, fences, handrail, and walkway shall be shown as applicable. Minimum horizontal clearances from centerline of track to nearest obstruction at top of rail elevation and above shall be provided. The section shall also show shoring wall embedment depth and approximate groundwater depth.

- c. Arrangement and sizes of shoring elements and details of all connections.
- d. Specifications for materials and requirements for shoring fabrication and installation.
- e. Construction sequence(s) detailing all steps in the shoring installation, excavation, and shoring removal. The Construction sequence(s) must be described specific enough for an inspector to verify the construction is installed properly in sequence.
- f. Track monitoring requirements (types, locations, reading schedule, etc.). See [Section 10](#) for requirements. Inclinometer may be required.

2.4 CALCULATIONS

Design calculations shall be provided for all elements of the shoring system.

The calculations shall consider each stage of excavation and support removal.

The calculations shall include estimates of shoring deflection, demonstrating that the proposed system will not cause excessive settlement of the tracks. See [Section 10.2](#) for settlement limitations.

A summary of the soil parameters used in the design shall be included in the calculations, and the source reference for these parameters shall be identified and provided. Include a copy of the geotechnical report.

Input and output from computer programs used for analysis and design of temporary shoring shall be accompanied by hand calculations verifying the input and results. In cases where the analysis methods used by the program are not shown in the output, appropriate documentation of the program's calculations shall be provided.

Loading diagrams from all sources (soil, Rapid Transit surcharge, equipment surcharge, water, etc.) shall be included for each stage and final stage of excavation, for both hand calculations and/or computer program calculations.

2.5 DESIGN CHECKLIST

The shoring designer shall complete, seal, and sign a copy of the Submittal Checklist included in [Appendix A](#) of these Guidelines. The independent QA/QC reviewer shall use the form completed by the shoring designer as a review checklist. The completed checklist shall accompany the shoring submittal. All revisions of the checklist and any additional review comments shall be included with clear revision numbers shown. Only the final approved revision



Section 2 – Coordination Flowchart and Submittal Requirements

of the structural Calculations and Drawings shall be submitted, however, all changes must be clouded and identified clearly with revision marks.

2.6 PROPRIETARY SYSTEMS

Use of proprietary systems, such as formwork, trench boxes or slide rail shoring, require that a Structural Engineer licensed in the state of Illinois confirm that the systems components are satisfactory for site-specific conditions. Manufacturers or suppliers cut sheets must be submitted, listing serial numbers of frames or boxes proposed for use on the project. Such cut sheets must clearly state the maximum loading and depths for which the system has been designed. These cut sheets must be stamped by the Structural Engineer (licensed in Illinois) who is approving the use of such system.

The structural engineer licensed in Illinois, as part of the calculation package shall provide documentation explaining that he/she has reviewed the analysis and/or testing verification done by the manufacturer and understand that he/she, by signing and sealing the calculation package with the proprietary products, are liable for any failure.

2.7 CONSTRUCTION PROCESS PLAN (CPP)

The construction of all shoring and all other construction activities within the Basic Safety Envelope and the Zone of Influence will require the Contractor to submit a Construction Process Plan (CPP). Adjacent Construction shall not commence without an approved CPP. Prior to starting the work, Contractor shall conduct a CPP briefing/pre-activity meeting with the crew and ensure all parties are familiarized with the approved CPP. The briefing points will be provided as comments by CTA Engineering upon review of the CPP.

The CPP is to include:

- a. Contact list with company names, direct phone numbers, and email addresses for all Adjacent Construction team members, including project manager(s), superintendent(s), Engineer(s) in responsible charge, etc.
- b. General project information includes project name, location, process plan activity, etc.
- c. A table of contents with PDF bookmarks created for all sections.
- d. Contingency plans that include any potential field changes anticipated by the Contractor that may occur on site which deviates from the submitted CPP seeking approval, such as equipment changes due to availability, shoring member size/material changes due to material availability, or shoring installation sequence deviations due to underground obstructions etc. If no deviation is anticipated, it shall clearly state no deviations from the approved CPP are anticipated on site.
- e. A summary that includes possible conflicts/issues with actions required. Note that if any unforeseen condition/conflict is encountered on site, CTA Inspectors shall be notified



Section 2 – Coordination Flowchart and Submittal Requirements

and consensus between CTA representative and Contractor's Engineer in Responsible Charge must be reached before work can resume.

- f. Contain a description of any proposed temporary changes to the Operating System.
- g. Describe the activities necessary to perform specific work within the Basic Safety Envelope and the Zone of Influence.
- h. Include a detailed schedule that indicates the expected hourly progress of each activity that has a duration of one hour or longer. The schedule shall include the time at which all activities planned under the CPP will be completed.
- i. Show each activity and where and how it affects the normal operation on the Operating System.
- j. Include all materials and equipment required to complete each activity in the CPP within the allotted time period. Show anticipated locations where equipment may be placed, especially equipment that has the potential to foul the tracks.
- k. Detailed Construction sequence(s) showing all steps in the shoring installation, excavation, and shoring removal based on the sequence(s) shown on the drawings.
- l. Detailed quality Control Plan that includes inspection and testing requirements, including any certificates such as welder's certificates and welding specification procedures, etc. Coordinate with item (m) and item (o).
- m. Form letter(s) from the shoring designer that confirms, for each stage of the construction or deconstruction, that installed shoring either in a temporary condition or a final condition, per his field review, conforms with the design intent. A signed and sealed version of these letters for each stage is to be delivered to CTA prior to the contractor progressing to the next stage of construction. Coordinate with item (o).
- n. Provide descriptions on how the embedment depth of ERS vertical components (sheet piles, soldier piles, etc) are measured.
- o. Provide hold point(s) for Construction Verification outlined in [Section 2.8](#).
- p. Detailed monitoring requirements per [Section 10](#). As an alternative, the monitoring plan can be included in a separate CPP submitted for review.
- q. Include contingency plans for putting the Operating System back in operation in case of emergency or in case the Contractor fails to perform and complete the work on time. Contingency plans shall address the various stages of construction and may require redundant equipment and personnel.
- r. A detailed job hazard analysis.
- s. Attach CTA approved Variance Requests associated with the work.



Section 2 – Coordination Flowchart and Submittal Requirements

- t. Include all required checklists in [Appendix A](#) where applicable to the work in the submitted CPP. The Construction Process Plan Checklist shall be attached for all CPP submitted to CTA for review.
- u. Detailed methods on how to identify underground utilities for any Adjacent Construction with excavation including boring construction.
- v. For CPP revisions, include a list of comments and detailed responses.
- w. Safety Related:
 - 1) Provide Name and Driving Directions to Nearest Hospital Location
 - 2) Provide a Site Evacuation Plan
 - 3) Provide the Weather Limitations and Contingency Plan for the project.
 - 4) Provide a Fall Protection Plan for working from Articulating Lift.
 - 5) PPE must be worn by all Tradespersons while working on project (including Mask /Face-coverings and gloves, as applicable)
 - 6) Plan must include actions being taken by construction personnel to address and mitigate an event or occurrence of Contagious Diseases / Outbreaks (i.e. COVID-19)
 - 7) Tradespersons must have valid CTA Rail Safety Training Cards with them for work. Random CTA audits are conducted.
 - 8) CTA Rail Safety Trained Personnel required for Slow Zone setup
 - 9) CTA Flaggers must be positioned with portable track trip system is in place prior to activities.
 - 10) Verification of inspection for all equipment and operator certification.
 - 11) Safety Briefing must be conducted together with all Tradespersons / CTA Personnel prior to the start of work and documented.
 - 12) Communication with the CTA Flaggers is vital during this operation. Maintain / adhere to communication with Flaggers: Flaggers will sound horn when train approaches, contractor to stop work, lower equipment and when train clears Flaggers will sound horn to proceed / continue with work
 - 13) No work shall be performed while Train Service proceeds through work zone. Materials must be secured.
 - 14) Ladders used for access to the ROW must be constructed from non-conductive material and have dual access rungs for use on both sides of the A-frame or shop made with safe extension of the side rails for Tradespersons to step-through.



Section 2 – Coordination Flowchart and Submittal Requirements

15) All required information for the construction equipment per [Section 3.9.1](#).

Based on the Coordination Flowchart, the CPP shall be submitted to CTA ~~eighty-one (81)~~ days prior to the start of the work within the Basic Safety Envelope. However, items shown in the Coordination Flowchart may overlap and the minimum days CPP must be submitted to CTA for review is ~~twenty-one (21)~~ prior to the start of the work.

The Contractor's construction activities shall minimize impact to the CTA Operating System.

2.8 CONSTRUCTION VERIFICATION

Temporary Shoring

The temporary shoring Engineer in Responsible Charge (or his/her authorized designee) shall visit the site and review the as-built shoring system to verify that the system is constructed in accordance with the shoring plans that have been reviewed and accepted by CTA. The Engineer in Responsible Charge shall prepare a letter that shall be submitted to CTA confirming that the shoring system has been reviewed and verified, which includes, but not limit to, overall condition, critical dimensions such as excavation depth, material, welds, etc. Any field changes shall be listed in the letter and the effect of those changes shall be evaluated by the Engineer in Responsible Charge. Any deficiencies noted by the Engineer in Responsible Charge shall be corrected by the Contractor. Deficiencies and corrections shall be noted in the letter with verification of adequate correction by the Engineer in Responsible Charge. If the shoring system is a pre-manufactured product, manufacturer shall provide a letter to confirm the correct product is installed.

The number of site visits and the stage or stages of construction at which they shall be performed can be suggested by the Shoring Designer, but will be specified by CTA as a condition of acceptance of the temporary shoring design. The intent will be to have the temporary shoring installation verified by the Engineer in Responsible Charge at critical construction stages. The confirmation letter required above shall be made for each construction stage.

Contractor shall provide evidence that ERS vertical components (sheet piles, soldier piles, etc) have achieved the design depth to Engineer in Responsible Charge and CTA.

Potholing Utilities

When potholing is required to verify existing CTA utilities per [Section 3.6](#), [Section 4.4](#), and [Section 4.5](#), Contractor shall submit a confirmation letter and provide evidence that existing CTA utilities have been located before commencing the proposed Adjacent Construction work. Evidence shall include:

- Photos during the potholing process
- Photos showing the existing CTA utilities after discovered, if visible.
- Photos showing the depth measurement process



Section 2 – Coordination Flowchart and Submittal Requirements

- Updated drawings with the field verified existing CTA utility locations and clearance dimensions to the proposed work

Welding

Contractor shall have a Certified Welding Inspector/Quality Representative on site to visually inspect all field welding and randomly select 15% of the field welds to measure lengths and throat thickness, except for the welds done per AWS D1.5 shall be 100% inspected to measure lengths, throat thickness, and overall weld quality. Contractor's Certified Welding Inspector shall document and record types and locations of all defects found in the work and confirm the measures taken to correct these defects.

Concrete Formwork

When potential failure of formwork poses a risk to CTA, as determined by same, the "Concrete Pre-Pour Checklist" as attached in [Appendix A](#) must be filled and submitted to CTA for record.

Micropile Installation

When micropile installation is within CTA track structure spread footing and based on the soil boring log, weak soil layers are expected within the Zone of Influence, the micropile design Engineer in Responsible Charge shall visit the site when the drilling occurs within the Zone of Influence and weak soil layers to monitor the installation process, verify if external flushing occurred, and provide necessary guidance when obstructions are encountered that casing can no longer advance without auger extending beyond the bottom edge of the casing.



(This page intentionally left blank.)



SECTION 3 BASIC CONSTRUCTION AND EXCAVATION REQUIREMENTS

3.1 ZONE OF INFLUENCE

The Zone of Influence is defined in **Figure 3 - 1**. The area below the influence line is divided into four (4) zones. Requirements and limitations for excavation and temporary excavation support systems within each zone are described in detail below. Excavation requirements apply on or off of CTA Right-of-Way. Excavation beyond the Zone of Influence shall satisfy OSHA and other applicable requirements per the governing jurisdiction.

When designing ERS for underground utility works, O/C/A/E shall assume the proposed utility alignment is two (2) feet deeper, and two (2) feet closer towards the CTA tracks, or towards the CTA underground utilities for jack-and-bore and horizontal directional drilling work.³



ZONE 1

- Excavation is prohibited. Casing/carrier pipe allowed where shown.



ZONE 2

- **No excavation or temporary shoring installation will be allowed without the special written permission of CTA.** Requirements for requesting a variance are provided in [Section 2.2](#).
- Dimension 5'-7" provides the very minimum clearance for the CTA train envelope for an installed ERS structure. However, installation procedures usually encroach into train envelope which may require track out of service if approved. The preferred and recommended clearance from face of the excavation to the centerline of track is 7'-2" which should be followed.
- If CTA grants a variance to allow excavation, vertical excavation with continuous shoring walls is required. Shoring installation shall be complete prior to any excavation. Design of the shoring system shall include lateral surcharge due to rapid transit live load.
- Examples of continuous shoring wall types include interlocked sheet piling or diaphragm walls. Sheet piling shall not cantilever in height exceeding four (4) feet in the final condition or during excavation stage before anchor/brace system can be installed⁴. Diaphragm wall types include deep soil mix walls, secant pile walls, and tangent pile walls. Soldier piles and lagging are not allowed if excavation is necessary to install lagging.
- Excavation shall have a length parallel to the track no greater than one-hundred (100) feet.



ZONE 3:

³See Section 3 Commentary

⁴See Section 3 Commentary



- **Excavation requires temporary shoring.** Vertical excavation with continuous shoring walls is required. Shoring installation shall be complete prior to any excavation. Design of the shoring system shall include lateral surcharge due to rapid transit live load.
- Examples of continuous shoring wall types are the same as Zone 2, only in Zone 3 soldier piles and lagging may be allowed. Cantilevered soldier piles and lagging (and sheet piling) shall not exceed six (6) feet in height in final condition or during excavation stage before anchor/brace system can be installed.⁵ Maximum excavation lifts shall be as directed by the Geotechnical Engineer depending on the soil type but shall not be more than five (5) feet for each stage of excavation for soldier pile and lagging walls or any other type of shoring that requires excavation of an open soil face prior to installing continuous support elements. Grouting is required behind the lagging to fill the voids.



ZONE 4:

- **Excavation requires temporary shoring.** Excavations shall be vertical. Continuous shoring walls installed prior to any excavation are preferred. Maximum excavation lifts shall be as directed by the Geotechnical Engineer depending on the soil type but shall not be more than five (5) feet for each stage of excavation for soldier pile and lagging walls or any other type of shoring that requires excavation of an open soil face prior to installing continuous support elements.
- The excavation shall be provided with a shoring system that actively supports the sides of the excavation and prevents the excavation faces from unraveling or moving. Sloped excavations are not permitted.
- Hydraulic and mechanical trench shores with sheeting, trench shields, and timber shoring may be utilized.

EXCAVATIONS BEYOND INFLUENCE LINE:

- Lateral surcharge due to rapid transit live load need not be considered in the shoring design. **It does not mean open cut is permitted outside the Zone of Influence line.**
- Shored vertical excavations are preferred. Sloped excavations are discouraged. CTA will require slope stability analysis and monitoring per [Section 10](#) and [Section 10.5](#).
- Excavation and temporary shoring shall comply with OSHA and other applicable requirements per the governing jurisdiction.

GENERAL REQUIREMENTS OF EXCAVATIONS IN ALL ZONES:

- Finished excavation surfaces shall be in uniform planes, with no abrupt breaks.
- Positive drainage shall be maintained away from the tracks and track subgrade at all times.
- Backfilling materials, procedures, placement, and performance criteria shall meet the requirements IDOT Standard Specification including aggregate base sub-ballast. Coordinate with CTA Engineering.

⁵See [Section 3 Commentary](#)



- When top of shoring wall is below the bottom of cross ties, existing ballast shall not be disturbed. If any disturbance to the ballast occurs, correction must be made immediately. The ballast shoulder width measured from the end of the cross tie to the point when ballast starts to slope shall be twelve (12) inches minimum⁶.
- Refer to [Section 10.3](#) for monitoring frequency requirement in all Zones.

SPECIAL REQUIREMENTS FOR JACK-AND-BORE CONSTRUCTION:

- Refer to [Section 4.4 and 4.5](#) for additional design and construction requirements.

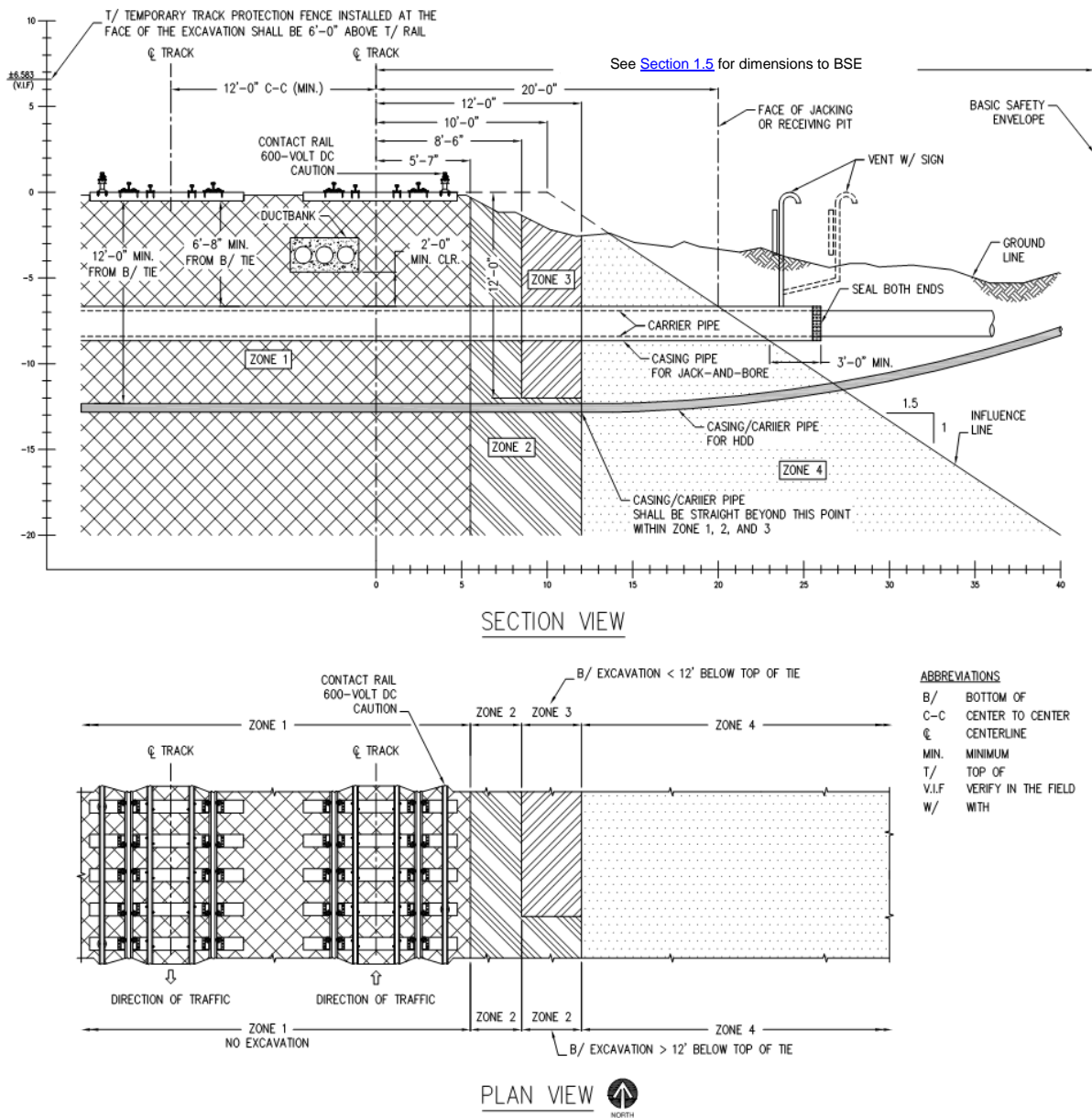

Figure 3 - 1: Zone of Influence

⁶See Section 3 Commentary



3.2 VARIANCES

CTA prohibits excavation in Zone 1 (with the exception of jack and bore construction as shown in **Figure 3 - 1**) and does not allow excavation in Zone 2 without special written permission. Variances for allowing excavation within Zone 2 may be granted on a case-by-case basis by CTA at its sole discretion. Planning, design, and bidding shall not be based on the assumption that a variance will be granted to allow shored excavation. Therefore, it is required by CTA for Adjacent Project Owner, Designers and/or Contractors to follow the procedures outlined in [Section 2.2](#).

3.3 EXCEPTIONS FOR MINOR CONSTRUCTION

CTA may permit unshored excavation within Zone 3 and Zone 4 provided that the excavation has a limited plan area and is no greater than five (5) feet in depth from top of tie. Further, excavation and backfilling must be completed during a single, uninterrupted period of time during which no train movements will occur on the adjacent track. Planning and bidding shall not be based on the assumption that an exception to the Zone of Influence shoring requirements will be granted.

Unshored excavation adjacent to a track will only be allowed in soil conditions that will permit the work to be performed without disturbing the adjacent track and/or the materials supporting the track.

Localized shallow trenching for utility installation and excavations for the installation of precast foundations (such as signal foundations) are examples of cases where exceptions may be granted. Exceptions will be granted on a case-by-case basis by CTA at its sole discretion. Factors CTA will consider when assessing whether or not to grant an exception include: the length of time required to complete the excavation and backfilling, the available time between train movements on the adjacent track, and local soil conditions.

3.4 RAIL SAFETY TRAINING

All Contractor/Subcontractor/Consultant personnel assigned to work on, under, above, or adjacent to the CTA Right-of-Way and inside Rail Maintenance Facilities adjacent to six-hundred (600) VDC, are required to successfully complete a one-day (8-hour) Rail Safety Training Course administered by CTA in order to qualify for a Rail Right-of-Way Safety Card. The course identifies the dangers that exist on the Rail System, including moving trains and the 600-volt DC Traction Power Distribution System.

For application, associated fees, and scheduling procedures, please refer to CTA Requirements for Contractors Working Along the Right-of-Way (R.O.W.) document available on the CTA Adjacent Construction Website: <http://www.transitchicago.com/nearbyconstruction/>.



3.5 RIGHT-OF-WAY

Rapid Transit Right-of-Way, in many cases, is owned and maintained by CTA. However, in some cases, CTA shares Right-of-Way with private railroad owners. For example, on sections of Midway Orange Line and Harlem Green Line, at embankments, CTA shares Right-of-Way with Railroads. The Contractor and/or Engineer in Responsible Charge shall coordinate with CTA Real Estate and Railroad for Right-of-Way ownership information. In order to perform work on their Right-of-Way, approval shall be obtained from Railroad. Design and construction of the earth retention system shall satisfy Railroad requirements and this Manual, whichever is stricter.

3.6 UTILITIES

In the City of Chicago, existing utilities shall be located prior to commencing any excavation. The Office of Underground Coordination (OUC) is the distribution agency within the Chicago Department of Transportation, Division of Infrastructure Management, for all requests regarding existing utility information and the review/approval of construction work in or adjacent to the Public Way. Proposed projects for new construction and installation work must be processed through the OUC Information Retrieval process to procure CTA infrastructure drawings. CTA is a member of OUC. Acceptance of the project by CTA does not constitute a representation as to the accuracy or completeness of location of the existence or non-existence of any utilities or structures within the limits of the project. For locating CTA existing utilities within the Basic Safety Envelope as defined in [Section 1.5](#), such as duct banks for signal cables, traction power cables, etc., it is required by CTA that Ground-Penetrating Radar (GPR) be used for any work that contains the scope of soil removal, i.e., excavation, boring, etc. For locating CTA existing utilities outside the Basic Safety Envelope, GPR shall also be used when the proposed work is within ten (10) feet clear distance from the faces of CTA existing utilities. In certain instances, CTA forces may provide assistance for locating CTA's underground utilities. GPR must be done by a qualified company that has successfully located utilities on railroad tracks (ballast can result in additional noise for GPR and is different from pavement). CTA would also recommend GPR be used to locate all other utilities. Refer to [Section 4.4](#) for additional potholing requirements for locating utilities for Jack-and-Bore Construction and Horizontal Directional Drilling Construction.

When locating non-CTA utilities outside the City of Chicago, follow the standard operating procedures of the local municipalities. At a minimum, coordinate with JULIE for underground utilities identification.

Other agencies utilities or assets that are located within CTA's Right-of-Way or property, Right of Entry shall be obtained before entering CTA's property for maintenances.

If any utilities are discovered on site that are not shown in the Information Retrieval documents, Contractor shall attempt to determine the possible owner of the utilities to determine the course of action. CTA Inspectors shall be notified with the coordination process and results. Adjacent Construction work shall not resume until the utilities have been identified and consensus between the Contractor and utility owner is reached, reviewed and agreed by CTA Engineering. If the discovered utilities have been abandoned, Contractor's Engineer in Responsible Charge



shall determine the negative effect to the adjacent CTA structures if the proposed work require a full or partial removal of the abandoned utilities and submit to CTA Engineering for review and approval.

3.7 SAFETY REGULATIONS

Specific safety regulations of CTA are provided in the CTA Safety Manual. Construction shall also conform to the OSHA Standards, as well as any other applicable government agency safety regulations.

The entire CTA Rail System has been divided into 198 Flag Zones. These Flag Zones are based upon which Rail Terminal has the responsibility of providing flaggers. The Flag Zone numbers emulate train run numbers assigned to the Terminal supplying the Flaggers (except for the loop). For easy identification, all Flag Zones are listed on a Flag Zone Index chart.

CTA Inspectors will assist Contractor to determine the number of flaggers required for the work based on the address of the worksite and means and methods in the process plan. Consult the "Flag Zone Guide" in the CTA's Flagger Requirements document to determine the minimum number of flaggers required. If work is performed in two or more flag zones, the flag zone shall govern the minimum number of flagger ordered with the highest/largest number of flaggers. Taking a track out of service with a Service Bulletin may reduce the total number of flaggers required. If the proposed Adjacent Construction work is deemed to be of higher risk to the CTA services, or unusual site constraints exist, a pre-activity meeting shall be held with the Contractor, CTA Inspectors, CTA Safety, and CTA Route Transportation Manger to review the proposed activities and site constraints to determine the required number of flaggers.

Once all of the R.O.W requirements have been met which includes Letter of Commitment, Deposit, RRP Insurance, Rail Safety Training, and an Approved CPP, the CTA Project Manager will notify the Contractor and send a blank flagger request spreadsheet. Contractor shall fill out and return the spreadsheet no later than noon on the Wednesday one week before the proposed work activities. After the flagger request is entered into the Rail Operations Personnel Request website, CTA Inspectors will receive a notification before the end of the day Friday in the same week if the request has been approved or denied. These procedures/timelines may change without notice in the ACM based on Rail Operations. Ensure to coordinate with Rail Operations for the most up-to-date flagger ordering procedures and timelines.

Refer to CTA's Flagger Requirements for additional information and refer to [Section 3.9](#) for more information on Single Track/Reroute.

Refer to [Section 2.7](#) for safety related Construction Process Plan (CPP) submittal requirements.

3.8 CONSTRUCTION

Construction of excavations or temporary shoring system within the Basic Safety Envelope and Zone of Influence, or with the potential of entering the Basic Safety Envelope and Zone of Influence requires a Construction Process Plan (CPP). See [Section 2.7](#) for CPP submittal



requirements. Once the applicable right-of-entry requirements, safety training requirements, accepted earth retention system design and drawings, and CPP are in-place, the Contractor may proceed with construction according to the design plans, specifications, and accepted CPP. Refer to the flowchart in [Section 2](#) for additional timeline and coordination information.

All ground penetrating structural components of the Earth Retention System shall be installed using methods proven to not impact adjacent structures.

Any damage to rails, ties, structures, embankments, Third Party property, signal, and communications equipment, or any other facilities during construction shall be repaired, at the expense of the Public Agency or Contractor doing the work, to a condition equal to or better than the condition prior to entry into the Basic Safety Envelope and to a level accepted by CTA. CTA reserves the right to back charge the Contractor for the affected rapid transit operation for any and all costs and expenses incurred as a result of their work, which may result in the following:

- Unscheduled delay to trains, or interference in any manner with the operation of trains.
- Unscheduled disruption to normal rapid transit operations.
- Unreasonable inconvenience to the public or private users of the system.
- Loss of revenue.
- Alternative method of transportation for passengers.

The Public Agency and Contractor shall comply with the rules and regulations as required by the CTA Safety Department after reviewing the CPP.

3.9 CONTRACTOR OPERATING RESTRICTIONS

All construction work within the Basic Safety Envelope or Zone of Influence shall be performed in accordance with an accepted CPP.

When operating near active tracks, whether on or off CTA Right-of-Way, the Contractor's operations will be constrained as necessary to protect the Operating System. In general terms, if the Contractor's operation has the potential to interfere with the safe passage of rapid transit traffic or has the potential to damage tracks or other CTA infrastructure, restrictions will be imposed on the Contractor's operations.

When working within the Basic Safety Envelope or within the Zone of Influence, the Contractor is considered to have the potential to damage the track, regardless of the operation or equipment being used. The Contractor will still be considered as having the potential to damage the track when working outside the Basic Safety Envelope, or Zone of Influence, depending upon the operation. For example, if the Contractor operates a crane or backhoe with a boom having sufficient length to encroach Basic Safety Envelope, or if the Contractor is handling long beams or piles that could fall across a track. Such operations will be constrained. For bridge girder erection above CTA tracks, refer to [Section 11.2.5](#) for additional requirements.



CTA has sole discretion to determine if the Contractor's work activities, and including mobilization and/or transportation of construction equipment, have the potential to impact its operations. Unless otherwise approved by CTA, the Contractor will not be permitted to perform operations that have the potential affect operations during morning or evening rush hours. Rush hour varies by lines and locations but typically it is Monday through Friday; mornings from 0500 to 0900 hours and afternoon from 1500 to 1900 hour. For rush hour on a specific line and location, coordinate with CTA Train Operation and attend the weekly rail operation meeting.

3.9.1 Construction Equipment

The construction equipment governed by this Section is defined as any powered equipment that facilitates the Adjacent Construction and has the potential to foul CTA tracks as defined above in [Section 3.9](#) and/or the failure of the construction equipment when being operated/mobilized within CTA's Basic Safety Envelope or within the Zone of Influence that has the potential to endanger the public, public or private Right-of-Way. **Construction Equipment approved in the CPP shall not be substituted.**

The storage, handling, transportation, mobilization, and operation of construction equipment shall comply with all OSHA Regulation Standard Number 1910 Subparts N, O, and P, or any Subparts, and OSHA Standard 1926.1427 for Operator Training, Certification, and Evaluation, that will govern the use of the specific construction equipment with the following additional requirements:

- The operation manuals of the construction equipment shall be included in the Construction Process Plan submitted to CTA as a part of the requirements in [Section 2.7](#) and all operational constraints/restrictions in the operation manual shall be highlighted.
- The manufacturer certified construction equipment load test results shall be included in the CPP.
- The maintenance and inspection log for the equipment shall be included in the CPP.
- The Contractor shall retain an Illinois licensed Structural Engineer and analyze the stability of the construction equipment in operational condition and mobilization condition. The stability check shall include overturning analysis with a factor of safety of 2.0, and sliding analysis with a factor of safety of 2.0. The analysis shall consider all of the possible equipment configurations and conditions with anticipated wind pressure, ground slope, or any forces/conditions that may affect the stability, and include both static and dynamic states. The dynamic state shall consider the worst case swing/rotational speed that can produce the worst case centrifugal forces with the least hold-down condition. If the worst case overturning or sliding factor of safety is less than 2.0 but greater than 1.5, a physical hold-down device shall be required, designed, and installed whenever the construction equipment is in the operational condition. If cribbing is used as construction equipment platform, it shall be restrained to prevent any sliding between the cribbing and soil or supporting structures below.
- A demonstration in a safe and controlled environment/site of the proposed equipment for the proposed work shall be performed to ensure the equipment is suitable for the



application, with either the restrictions from the operational manual, or further restrictions required by the SE calculations:

- The construction equipment, in its operational position, shall be on level ground within one (1) degree grade.
- Before traveling/swinging a construction equipment with load, a designated person shall be responsible for determining and controlling safety. Decisions such as position of load, boom/mast location, ground support, travel route, and speed of movement/rotation/swing shall be in accord with his/her determinations based on the operation manual and analysis.
- Construction equipment operators and their immediate supervisor shall complete a course in accident prevention and the course shall consist of instruction suited to the particular operations involved.
- No construction equipment is allowed to encroach into the CTA Train Envelope within 7'-2" distance from the centerline of the track and above the Train Envelope when a passing train is present. Refer to [Appendix B](#) for more detail. Construction Equipment operators must keep their hands and feet clear of all equipment controls while the train is passing.

Whenever a construction equipment has an overall height (highest point of the equipment) more than two times the height of the equipment main body, but the construction equipment is not categorized as a crane with manufacturer tested load tables, the following additional requirements shall apply (for example, an excavator with mast module mounted):

- The hydraulic mast foot shall be installed and engaged whenever the mast is extended. The mast foot shall bear on sound and leveled ground.
- In both the operational and mobilization states when the mast is vertically positioned, the construction equipment shall not be positioned in a way that there is no ground for mast foot to bear on.
- Before construction equipment swings or travels with load and the mast vertically positioned, mast shall be fully retracted.
- If mast is segmented, the mast shall not extend taller than what is required for the work.
- **Modifications on the equipment is not permitted.** For example, change of counterweights, undercarriage, mast, etc.

3.9.2 Slow Zones

A Slow Zone, as outlined in Transit Operations Standard Operating Procedure (SOP) No. 7041 is required when The Contractor's work is within the CTA Basic Safety Envelope or Zone of Influence, and the duration of the work is one-half hour or more. Refer to SOP No. 7041 for responsibility, set-up, standard operation and removal of the Slow Zone.

An Extended Duration Construction Slow Zone shall be required when one or more conditions as shown below are expected to occur and remain outside of the scheduled flagger/Slow Zone protected work period, or require as determined by CTA, in which case, the Infrastructure



Division Standard Operating Procedure IC-SOP-P002 shall be used in conjunction with SOP No. 7041.

- Construction activity adjoining, above, or beneath CTA tracks (within CTA Basic Safety Envelope) that has the potential for personnel, material, or equipment to accidentally intrude upon a train's clearance envelope. This would exclude ground level work activities above CTA subway tunnels.
- Excavation under or adjacent to (within the Zone of Influence) to any ballasted track or elevated, subway or earth retention structures, except minor excavations in Zone 4 of **Figure 11 - 2** above CTA subway tunnels.
- Any shoring required of an elevated track structure.

During review of Contractor Construction Process Plans, the CTA Project Manager and CTA Construction Safety shall evaluate the nature of the construction work and the manner in which it is proposed to be performed. If any of the activities or conditions on the IC-SOP-P002 checklist in [Appendix A](#) are expected to occur and remain outside of the scheduled flagger/slow zone protected work periods, the checklist shall be submitted to the CTA chief Engineer noting the anticipated conditions. Include with the checklist a full description of the work and include limits, duration and precautionary measures planned to minimize risk to the CTA's operations and property. The Chief Engineer or his Designee will determine the need and detailed requirements for a construction related slow zone during non-work hours.

At the end of each work shift and prior to releasing flaggers from a flagger protected work zone, or prior to returning track to normal service, the CTA Inspectors shall inspect the site and determine whether any conditions described on the IC-SOP-P002 Checklist in [Appendix A](#) exist which could warrant the continuation of reduced train speed. Any concerns or issues should immediately be brought to the attention of the Chief Engineer (or authorized representative) prior to releasing the flaggers and increasing allowable train speeds through work zone.

3.9.3 Single Track/Line Cut

In general, a Single Track or Line Cut is required if the Contractor's work is within the CTA Train Envelope Clearance, or when there is no way to clear the CTA Train Envelope without incurring significant train delays or risk to the Operating System as determined by CTA. In most cases power down is also requested unless the timeline or nature of the work warrants an exception. A list of common situations is provided as following to demonstrate when Single Track or Line Cut is required. Adjacent Construction scope of work should be coordinated with CTA Construction, Safety and Rail Operations in a timely manner to secure flaggers, Single Track or Line Cut.

To take a track out of service, a completed "Single Track/Reroute Request" form must be submitted to the Office of the Vice President, Rail Operations in advance of the scheduled work. Coordinate with Rail Operations for form submission requirements. The Contractor is encouraged to submit the five week lookahead schedules at the Rail Operation meeting to coordinate track access with other projects on the same route. Note that any changes to the submitted Rail Service Bulletin requests also require at least 2 weeks' notice, therefore coordination is essential to ensure the accuracy of the request submitted. Whenever possible,



the person in charge should request a meeting with CTA Route Transportation Manager, Power & Way Engineering, and Signal Department. Taking a track out of service with a Service Bulletin may reduce the total number of flaggers required. For more information, refer to CTA's Flagger Requirements.

Single Track/Reroute

- Swing Stages/Tuckpointing - Only required for the portion of work within the Train Envelope
- Caissons/Earth Retention Systems - Only required if the caisson/ERS is within the Train Envelope
- Bridge Erection/Demolition - Depends on site conditions as well as the Contractor's means/methods
- Crane/Man Lift Extended Over the ROW - Depends on the nature/duration of the work - most work can be accomplished with flaggers and 3rd rail covers
- Track Work - Most cases require a single track, line cut or multiple tracks O/S. If clearances allow, construction fence / protective barriers are required when working on the ROW to delineate the work zone from any active tracks.

Line Cut

- Structural Steel Modifications - Depends on the nature of the work, but may be required for replacement of track stringers, girders, and columns
- Bridge Erection / Demolition - Depends on site conditions as well as the Contractor's means/methods
- Track Work

Debris Netting / Protective Barriers

- Swing Stages / Scaffolding - Required to prevent loose material/debris from fouling the ROW
- Mid / High Rise Construction - Required to prevent loose material/debris from fouling the ROW
- Bridge Decks - Required along the handrail to prevent loose material/debris from fouling the ROW

For IDOT projects regarding and coordination requirements, refer to Master CTA Spec for IDOT projects - CTA Flagging and Coordination.

CTA will not operate work trains, nor allow the Contractor to operate work trains, along the corridor to transport equipment and materials for the Adjacent Construction Projects, unless otherwise approved by CTA.

Contractor's activities that have the potential to affect CTA operations (active or otherwise) may be suspended during all train movements within the construction limits.

The Contractor will generally be directed by CTA flaggers and/or inspectors as to the need to suspend operations. The number of flaggers and inspectors will be determined by CTA per its review of the Contractor's CPP.



Approval of Contractor hours and activities will be determined by the CTA per its review of the Contractor's CPP.

Refer to the CTA Safety Manual for additional details.

3.10 TRACK PROTECTION FENCES

Track protection fences shall be provided, placed, and secured a minimum of 7'-2" clear from the centerline of the nearest active track and height shall be 6'-0" above top of running rail. If CTA grants a variance to allow excavation 5'-7" from the centerline of the nearest active track, the track protection fences can be connected to and supported by shoring walls to satisfy the above 7'-2" clearance requirement. Clearance less than 7'-2" must be approved by CTA.

[Appendix G](#) contains a CTA pre-approved track protection fence detail.

Refer to the CTA Safety Manual for additional details.

3.11 HANDRAILS AND WALKWAYS

If CTA grants a variance to allow excavation 5'-7" from the centerline of the nearest active track, and the track protection fences, at a distance of 7'-2" from centerline of closest track, are connected to and supported by shoring walls, adequate walkways shall be provided in accordance with OSHA requirements between the face of the shoring walls and the track protection fences. Walkway supports may be connected to and supported by shoring walls. The walkway surface shall be even with the top of shoring. Handrails may be provided independently from the track protection fences per OSHA requirements, or the track protection fences can be designed to act as handrails.

Handrails and walkways shall be designed in conformance with the requirements of Article 8.5 "Walkways and Handrails on Bridges" of the AREMA *Manual for Railway Engineering* and OSHA Standards. The walkway and support design are required to support a one-hundred (100) psf gravity live load to secure as an emergency evacuation route for the CTA passengers.

For temporary handrails/guardrails and walkways within the CTA's Zone of Influence but not intended to act as emergency evacuation route for the CTA passengers and only required to facilitate the adjacent construction work, OSHA requirements shall govern the design.

Any handrails/guardrails and walkways within the CTA's Zone of Influence, OSHA requirements shall govern inspection and maintenance. Adjacent Construction Contractor shall perform necessary maintenance to ensure the walking-working surfaces and guardrails are maintained free of hazards such as sharp or protruding objects, loose boards, etc. Adjacent Construction Contractor shall also ensure walking-working surfaces/guardrails are inspected regularly and as necessary, and maintained in a safe condition not only for the workers, but also to prevent any objects falling on the CTA R.O.W. When any correction or repair involves the structural integrity of the walking-working surface and guardrails, the designer of responsible charge shall evaluate the repair and qualified person shall perform or supervise the correction or repair. At the end of each shift before the construction site is shut down, a brief safety walkthrough shall be



conducted to confirm the walking-working surfaces/guardrails are secure without loose boards. If high wind is anticipated by weather forecast, generally defined as: (1) wind speed equal or greater than 40 mph lasting one hour or longer, or (2) wind speed equal or greater than 58 mph for any duration. Adjacent Construction Contractor shall coordinate with the walking-working surfaces/guardrails, or any other temporary structures used to facilitate the adjacent construction designer of responsible charge to evaluate if any measures should be taken to secure said temporary structures. A more detailed safety walkthrough shall be conducted before the forecasted wind event.

3.12 CLEARANCES

All elements of the shoring system shall be placed such that they satisfy the clearance diagram per [Appendix B](#).

3.13 SHORING REMOVAL

At the conclusion of construction, staged backfill and removal will often be necessary to safely remove bracing and connection elements of the shoring system. Unless otherwise approved by CTA, shoring walls/piles shall be mostly left in place with partial removal to elevation as required by CTA. If CTA approves to remove shoring systems, removal of these elements shall be included as part of the shoring construction sequence included in the signed and sealed design drawings and the CPP. The Contractor shall comply with removal requirements as stated on the CPP and drawings. Contractor removals shall not proceed if safety of operations is jeopardized or if CTA determines that safety could be jeopardized. Monitoring per Section 10 is to also continue through this activity.

Vertical shoring elements (sheet piles, soldier piles, and diaphragm walls) shall be mostly left in place unless otherwise approved by CTA. Vertical shoring elements shall be cut off or demolished to two (2) feet below bottom of track ties if within twelve (12) feet horizontally from centerline of track, unless otherwise directed by the CTA based on evaluation of the site on a case-by-case basis.

If the Contractor desires complete removal of vertical shoring elements for salvage or reuse, the Contractor shall submit the proposed removal procedure to CTA. The proposed removal procedure shall include provisions that will prevent movement or settlement of the track(s) and fill all voids that might remain after shoring removal. Complete removal of vertical shoring elements may be allowed by CTA at their sole discretion.



(This page intentionally left blank.)



SECTION 4 TEMPORARY SHORING SYSTEM

4.1 OWNER/CONTRACTOR-DESIGNED TEMPORARY SHORING REQUIREMENT

For construction projects that will require temporary shored excavation within the Zone of Influence, CTA strongly recommends that Contract Documents (plans, specifications, and estimates) include detailed design drawings and specifications for temporary shoring system. (However, temporary shored excavation as a performance item that is Contractor-Designed will also be accepted.) In addition to clarifying the required construction sequence, defining the impacts to the Operating System, and having a temporary shoring system accepted by CTA prior to the onset of construction, uncertainty regarding the time and expense required for the Contractor to prepare a temporary shoring submittal that satisfies CTA requirements may be effectively eliminated.

4.2 PERMITTED SHORING TYPES AND ELEMENTS

4.2.1 Permitted Without Restrictions

The following types of shoring are permitted by CTA for use within the Zone of Influence:

- Continuous Shoring Walls, such as sheet piling and diaphragm wall systems that are completed in place prior to any excavation are permitted in all Zones.
- Deep Soil Mix Walls and Sheet Piling: Based on other transit agency's experience that the soil mixing (drill) rig and other equipment utilized during a soil mixing operation typically pose a lesser risk than the pile driving equipment utilized to install sheet piling. Additionally, pre-drilling and vibration associated with sheet pile installation and extraction can cause track settlement. Consequently, the Contractor's operations may be somewhat less restricted if deep soil mix walls are used in lieu of sheet piling. Soil mix walls are generally used for deep excavation adjacent CTA subway structures. Refer to [Section 11.1](#) for construction adjacent to CTA underground structures. For secant pile analysis, construction tolerances shall be considered during design. A combination of 2" offset plus 1% vertical out-of-plumb which produces the smallest overlap shall be checked against compression and shear as an arch, unless a more restrictive tolerance is proposed by the Installer. The overlap out-of-tolerance check can be waived if the secant pile size and spacing are selected so that the overlap remains a minimum of 20% pile diameter with the worst-case tolerance condition as mentioned above.
- Preloaded Bracing: Preloading of bracing elements can reduce shoring deflection and ground settlement during excavation and assure good bearing and a tight fit between shoring elements. Where feasible, struts shall be preloaded to about 50% of their design load to achieve adequate bearing between connected shoring elements and to reduce the track settlement that can occur during excavation.



4.2.2 Permitted With Restrictions or Variance Request

The following types of shoring are permitted by CTA for use within the Zone of Influence but with restrictions:

- Soldier pile and lagging systems, have lagging members installed as excavation proceeds. During the excavation process, vertical cuts (of limited extent) are required to stand unsupported until the lagging has been installed. During the time, the ground is unsupported and raveling or ground loss can result in ground settlements that negatively impact track profile and alignment. Additionally, if the lagging is not installed tight to the excavated ground, the ground will tend to move to fill the gaps, which can result in settlement behind the shoring wall that negatively impacts track profile and alignment. Therefore, this type of shoring is not permitted in Zone 2 in **Figure 3 - 1**. However, when there are underground utilities and continuous shoring walls must be interrupted locally, soldier pile and lagging systems are permitted to be used in Zone 2 in **Figure 3 - 1** locally to clear the underground utilities.

The following types of shoring are permitted to use within the Rapid Transit Zone of Influence only when Variance Request is approved by CTA.

- Tiebacks: Tiebacks shall not be utilized to shore excavations within the Rapid Transit Zone of Influence. In addition, tiebacks shall not extend into the Rapid Transit Zone of Influence from walls supporting excavations outside of the Rapid Transit Zone of Influence. If the use of tieback system is approved by CTA, refer to [Section 8.1.3](#) and [Section 9.5](#).
- Micropiles with Laggings: Micropiles with Laggings shall not be utilized to shore excavations within the Rapid Transit Zone of Influence. If the use of micropiles with laggings system is approved by CTA, refer to [Section 8.1.6](#) and [Section 9.7](#).
- Slurry Wall: Slurry walls shall not be utilized to shore excavation in Zone 2 of the Rapid Transit Zone of Influence in **Figure 3 - 1**. If the use of slurry walls is approved by CTA in other Zones, installation of slurry wall shall avoid weekday commute hours, and must work around the weeknight and weekend train traffic. Excavations shall not commence until the slurry walls achieve the design strength.

4.3 PROHIBITED SHORING TYPES AND ELEMENTS⁷

The following types of shoring are prohibited from use within the Rapid Transit Zone of Influence with no exceptions:

- Soil Nailing: Soil nailing shall not be utilized to shore excavations within the Railroad Zone of Influence. In addition, soil nails shall not extend into the Rapid Transit Zone of

⁷See Section 4 Commentary



Influence from walls supporting excavations outside of the Rapid Transit Zone of Influence.

- Helical Screw Anchors: Helical Screw Anchors shall not be utilized to shore excavations within the Rapid Transit Zone of Influence. In addition, helical screw anchors shall not extend into the Rapid Transit Zone of Influence from walls supporting excavations outside of the Rapid Transit Zone of Influence.

4.4 JACK AND BORE CONSTRUCTION

Pipelines under or across CTA tracks on Right-of-Way shall be encased in a larger pipe or conduit called the casing pipe. Casing pipe will be required for all pipelines carrying oil, gas, petroleum products, or other flammable, highly volatile substances which, from their nature or pressure, might cause damage if escaping on or near CTA tracks or property. Unless other measures are put in place to mitigate safety concerns, to the satisfaction of CTA. For non-pressure water, sewer, or drainage crossings where the installation can be made without interference to transit operations, the casing pipe may be omitted when the pipe strength is capable of withstanding transit live loading. This type of installation must be approved by the CTA. All casing pipes, except those laid longitudinally, shall be sloped not less than 0.3%.

Pipelines perpendicular to the transit Right-of-Way shall be laid across the entire width of the Right-of-Way. Casing pipe shall extend beyond the Zone-of-Influence line shown in **Figure 3 - 1** by at least 3'-0" each end.

Pipelines laid longitudinally on transit Right-of-Way shall be located outside the Zone-of-Influence line as practicable as possible. However, if it is not practical and the pipelines are within the Zone-of-Influence, casing pipe shall be provided, unless otherwise approved by CTA.

Where practicable, pipelines shall be located to cross the tracks at approximate right angles, but preferably at not less than forty-five (45) degrees. In most cases, CTA will provide location of the existing ductbanks.

The minimum clearance from the edge of CTA existing utilities to edge of proposed pipeline shall be 2'-0" as shown in **Figure 3 - 1**. In most cases, CTA will provide the general location of the utilities upon initial coordination. However, in addition to requirements shown in Section 3.6, potholing must be performed whenever proposed infrastructure or utilities will traverse CTA utilities. Contractor must make reasonable efforts to expose the edge of existing CTA utility nearest the proposed pipeline to verify clearance. When reasonable efforts do not allow for exposure of nearest edge of existing CTA utility, CTA will require additional clearance to account for unknowns.

Pipelines shall not be placed within a culvert, under transit bridges, or closer than 45 feet to any portion of a transit bridge, station, or other facilities, except in special cases, and then by special design, as approved by the CTA.



Any replacement or modification of an existing carrier pipe and/or casing shall be considered a new installation, subject to the requirements of this Manual.

Where laws or orders of other public authority prescribe a higher degree of protection than specified herein, the higher degree so prescribed shall be deemed a part of this Manual.

Stray current from the electrified tracks must be expected and accounted for in protection of pipelines and casings. Pipelines and casings shall be suitably insulated from the stray current and any underground conduits carrying electric wire on CTA property.

For pipelines carrying flammable or hazardous materials, ANSI Codes B 31.8, and B 31.4, current at time of constructing the pipeline, shall govern the inspection and testing of the facility on CTA property, except that proof-testing of strength of carrier pipe shall be in accordance with the requirements of ANSI Code B 31.4, as applicable, for all pipelines carrying all liquefied petroleum gas, natural or manufactured gas, and other flammable substances.

Cathodic protection shall be applied to all pipelines and casings carrying flammable substances. Where casing and/or carrier pipe is cathodically protected by other than anodes, the CTA shall be notified and suitable testing shall be made. This testing shall be witnessed by the CTA to ensure that other transit structures and facilities are adequately protected from the cathodic current in accordance with the recommendations of Reports of Correlating Committee on Cathodic Protection, current issue by the National Association of Corrosion Engineers.

The Owner or its Contractor may be required to provide a non-refundable lump sum payment for “after the fact maintenance”. The determination of this amount is based on the individual situation but usually for jack-and-bore operation directly underneath the tracks with an open cut. No work will be allowed until this payment is received if the payment is requested. This payment is not to be confused with payments for items mentioned in [Section 1.2](#), or for flagging, inspection, etc.

There are special requirements in regard to monitoring frequency during the Jack-and-Bore construction in [Section 10.3](#), and special loading requirement for casing pipe design in [Section 5.4](#). Users of this Manual shall pay attention to these additional requirements.

Casings for carriers of non-flammable substances shall have both ends of the casing blocked in such a way as to prevent the entrance of foreign material, but allowing leakage to pass in the event of a carrier break. Where ends of casing are at or above ground surface and above high-water level, they may be left open, provided drainage is afforded in such a manner that leakage will be conducted away from transit tracks and structures.

Casings for carriers of flammable substances shall be sealed to the outside of the carrier pipe. Details of seals shall be shown on the plans. Sealed casings for flammable substances shall be properly vented with proper signage. Vent pipes shall be of sufficient diameter, but in no case less than two (2) inches in diameter, and shall be attached near each end of the casing and project through the ground surface at Right-of-Way lines or not less than ~~forty-five (45)~~ feet (measured at right angles from centerline of nearest track). Vent pipes shall extend at least four (4) feet above the ground surface. Top of vent pipe shall have a down-turned elbow, properly



screened, or a relief valve. Vents in locations subject to high water shall be extended above the maximum elevation of high water and shall be supported and protected in a manner approved by the CTA. When the pipeline is in a public highway, street-type vents shall be installed.

For casings for carriers of flammable substances, pipe joint shall be field welded with a single bevel groove butt weld that develops the full capacity of the intact casing pipe and shall conform to the latest AWS 1.1 by a certified welder.

Detailed method of installation shall be provided in the CPP as specified in [Section 2.7](#) with the following requirements:

General:

- The use of water or slurry under pressure (jetting) or puddling shall not be permitted to facilitate boring, pushing, or jacking operations. Water or slurry used to lubricate the cutter and pipe is acceptable.
- Unless otherwise directed by the Geotechnical Engineer in Responsible Charge, indicated in the CPP and approved by CTA, pipe, conduit, and casing installation under tracks shall be progressed on a continuous basis without stoppage, except for adding sections, until the leading edge has reached the receiving pit, or (ten) 10 feet beyond the CTA Zone of Influence, whichever is greater.

Jacking:

- This method shall be in accordance with the AREMA Manual, Volume 1, Chapter 1, Part 4, "Earth Boring and Jacking Culvert Pipe Through Fills." This operation shall be conducted without handmining ahead of the pipe and without the use of any type of boring, augering, or drilling equipment.
- Bracing and backstops shall be designed and jacks with sufficient rating used so that the jacking can progress without stoppage (except for adding lengths of pipe) until edge of the pipe reaches the receiving pit, or 10 feet beyond the CTA Zone of Influence, whichever is greater.
- During jacking, an earth plug 1.5 times the diameter of the casing shall be maintained at all times. Jacking operations shall be continuous on a twenty-four (24)-hour per day basis until edge of the pipe reaches the receiving pit, or ten (10) feet beyond the CTA Zone of Influence, whichever is greater.

Auger Boring:

- This method consists of pushing the casing pipe into the earth with a horizontal auger boring machine with an auger rotating within the casing pipe to remove the spoil. The front of the pipe shall be provided with mechanical arrangements or devices that prevent the auger from leading the casing so that no unsupported excavation is ahead of the casing. The auger and cutting head arrangement shall be removable from within the pipe in the event an obstruction is encountered. The over-cut by the cutting head shall not exceed the outside diameter of the casing pipe by more than one-half inch. The face of



the cutting head shall be arranged to provide reasonable obstruction to the free flow or running of earth material.

Any method which employs simultaneous boring and jacking or drilling and jacking for pipes over eight (8) inches in diameter that does not adhere to the above mentioned requirements will not be permitted.

If an obstruction is encountered during the installation which stops the forward action of the pipe, and it becomes evident that it is impossible to advance the pipe, operations will cease and the pipe shall be abandoned in place and filled completely with grout. Detailed procedures for filling abandoned pipe with grout must be included in the CPP. When water is known or expected to be encountered at the site, The Owner or its Contractor shall lower and maintain the ground water level a minimum of two (2) feet below the invert of casings at all times during construction, if approved by the Geotechnical Engineer in Responsible Charge and approved by CTA. See [Section 9.2](#) for dewatering requirements.

Requirements in [Section 4.5](#) items 5 through 10 shall also apply to this section.

All underground utilities constructed within CTA's Zone of Influence, or abandoned in place is subject to CTA independent inspection and acceptance.

4.5 HORIZONTAL DIRECTIONAL DRILLING CONSTRUCTION

The American Railway Engineering and Maintenance-of-Way (AREMA) has assigned a working committee to develop a recommended railroad industry practice for horizontal directional drilling (HDD) under railroad right-of-way. The interim guidelines listed below are issued by the Union Pacific Railroad (UPRR) and are adopted by the CTA. Pending completion of the AREMA recommended practice, at which time CTA will review and determine whether to adopt it. Existing CTA utilities verification shall comply with [Section 3.6](#) and [Section 4.4](#).

This method consists of utilizing specialized drilling equipment to bore a small diameter pilot hole along the desired alignment using a mechanical cutting head with high-pressure bentonite slurry to remove the cuttings. The drill string is advanced with the bentonite slurry pumped through the string to the cutting head and then forced back along the string, carrying the cuttings back to the surface for removal. After the cutting head reaches the far side of the crossing, it is removed and a reamer (with a diameter wider than the cutting head) is attached to the lead end of the drill string. The casing is attached to the reamer and the casing is then pulled back into its final position.

1. For all liquid or gas pipelines, only steel pipe may be installed under tracks or CTA right-of-way utilizing HDD. The pipe may be used as a carrier pipe or a casing pipe. Plastic carrier pipe, if used, must be installed in a steel casing.
2. For fiber optics or electrical installations, plastic pipe may be used as a conduit.
3. For all liquid or gas installations, also see [Section 4.4](#), with casing not exceeding sixty-three (63) inches, minimum cover (measured from bottom of tie to top of pipe) shall be



twelve (12) feet, regardless of product. For fiber optics or electrical installations, with casing/conduit nominal size of 6 inches or less, minimum cover shall be twelve (12) feet. Submittal shall include actual planned depth of pipe under each track.

4. Pipe specification must be provided and it shall satisfy AREMA recommendations and all applicable government and industry regulations.
5. Qualifications of drilling Contractor must be submitted which shall include specific instances of previous successful experience in drilling under sensitive surface facilities.
6. Construction Process Plan must be submitted per [Section 2.7](#). The CPP shall include description of the anticipated rig capacity, the proposed equipment and the method for advancing the borehole through expected soil conditions, angles, depth, and exact location of the exit ditch, the pilot hole diameter, the proposed reaming plan, including the number and diameter of pre-reams/back-reams and diameter of the final reamed borehole, and the contingency equipment and plans for dealing with soil conditions that a Geotechnical engineer could reasonably expect to be encountered at the proposed HDD installation site. The CPP shall also address the anticipated hours of operation during the HDD borehole drilling and installation process, the minimum number of personnel, and their responsibilities on-duty and on-site during all HDD drilling operations. Installation shall follow the approved CPP with the following requirements:
 - a. Excavating the soil by means of jetting of fluid or jetting of slurry are not allowed.
 - b. Slurry use shall be kept to a minimum and shall only be used for head lubrication and/or spoils return. The Contractor shall calculate anticipated slurry use and monitor actual use during the boring operation in order to determine the slurry loss into the surrounding soil. The bentonite slurry shall seal the annular space between the casing and the excavated soil with a minimum return of 95%.
 - c. HDD operation within the CTA Zone of Influence shall be advanced in a timely manner with minimal breaks in operation and no change in crew or operator.
7. The Contractor must provide a detailed Fracture Mitigation (frac-out) Plan including method of monitoring and capturing the return of drilling fluids with particular attention to prevention of in advertent escape of drilling fluids where they could undermine the tracks.
8. Establish a Survey Grid Line and provide a program of monitoring and documenting the actual location of the borehole during drilling operations.
9. An Authority assigned inspector and the Contractor's monitoring engineer are required to monitor the ground, ballast, and track for movement during the drilling, reaming, and pullback process per [Section 10](#). All work within the right-of-way Basic Safety Envelope must be coordinated with the flaggers. The installation process must be immediately stopped if movement is detected. The damaged area must be immediately reported to the Authority and immediately repaired subject to Authority review and approval. The



installation process must be reviewed and modified as required before the installation may proceed.

10. Upon completion of the HDD installation work, the Contractor shall provide an accurate as-built drawings of the installed HDD segment. As-built drawings will include both horizontal and profile plan.
11. All underground utilities constructed within CTA's Zone of Influence, or abandoned in place is subject to CTA independent inspection and acceptance.





SECTION 5 LOADING ON TEMPORARY SHORING SYSTEM

5.1 GENERAL

Lateral loading from the following sources shall be considered in the design of the temporary shoring system:

- Retained Soil
- Retained Groundwater (hydrostatic pressure)
- Surcharge from all applicable sources, including, but not limited to, CTA train and/or railroad live load, equipment and vehicles, material stockpiles, structures, and improvements, etc.

Earthquake (seismic) loading need not to be considered.

Other sources of load, including centrifugal force from a train, impact loads, thermal loads, and wind loads are typically not required to be considered in the design. Such loads need only be considered in cases where they are significant. For example, centrifugal forces may need to be considered in the design of a shoring system constructed at a curve over which trains travel at high speeds.

5.2 SOIL LOADS

The following examples are located within Appendix C

[Example 5.1 Develop an Active Soil Pressure Diagram](#)

[Example 5.2 Develop an Apparent Pressure Diagram](#)

[Example 5.3 Determine Passive Resistance \(Cohesionless Soil\)](#)

[Example 5.4 Determine Passive Resistance \(Cohesive Soil\)](#)

5.2.1 Soil Types and the Determination of Soil Properties

Soil types and applicable properties shall be ascertained by taking borings and performing appropriate field and laboratory test. Sufficient geotechnical exploration shall be performed to establish an understanding of the soil profile for the subject site. Refer to **Figure 5 - 1**, **Figure 5 - 2**, **Figure 5 - 3**, for examples of an acceptable soil boring layout.

Soil borings shall be in accordance with the current issue of the AREMA *Manual for Railway Engineering* Chapter 1, Part 1, “Specifications for Test Borings”. In addition to establishing the soil profile, key soil parameters for the design of shoring to be ascertained during exploration include the unit weights and strengths for the soil [i.e., the cohesion (c), and angle of internal friction (Φ)].

Vane Shear Test is to be performed to determine the undrained shear strength (S_u) for soft clays - less than one (1) tsf bearing pressure. The peak undrained shear resistance value



measured from the test shall be corrected based on the liquid limit.⁸ If clay contains silt or sand, the test results become less reliable. The Geotechnical Engineer and/or the Engineer in Responsible Charge shall use caution when using the test results for analysis.

Soil boring logs shall be accompanied by a plan drawn to scale showing location of borings in relation to the tracks and the proposed shoring wall and/or pipe (for jack-and-bore construction) locations, the elevation of around surface at each boring, and the elevation of the base of running rail of the tracks. See additional requirements for drawings in [Section 2.3](#).

The design soil properties shall be established by a Registered Geotechnical Engineer, or, alternatively, by a licensed Professional Engineer specializing in geotechnical engineering.

At a minimum, boring depth shall be 1.5 times the minimum embedment depth specified in [Section 7.8.1](#) for excavation with Earth Retention System.

Figure 5 - 2 and **Figure 5 - 3** below are only intended for open cut if permitted by the Authority per [Section 3.1](#). Soil under CTA tracks, especially in the case of open cut embankments can have a different soil profile than the soil under the Adjacent Facility which can have significant impact on the open cut stability analysis. Therefore, soil borings shall be done adjacent to and along CTA tracks with a maximum spacing of 100'-0". Unlike ERS where the passive side of soil profile is more important. For slope stability analysis, since the soil along the slip surface is providing sliding resistance, it is important to better understand the soil profile in the transverse direction of centerline of tracks. Therefore, a minimum of two (2) soil borings are required per **Figure 5 - 3** and the soil boring depth shall extend below the anticipated slip surface.

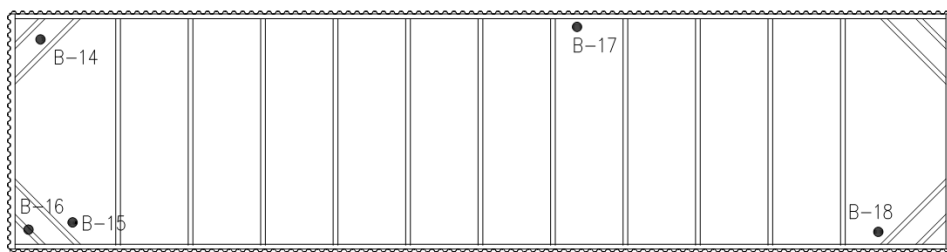

CL TRACK 1
CL TRACK 2

Figure 5 - 1: Typical Soil Boring Locations for ERS

⁸See [Section 5 Commentary](#)

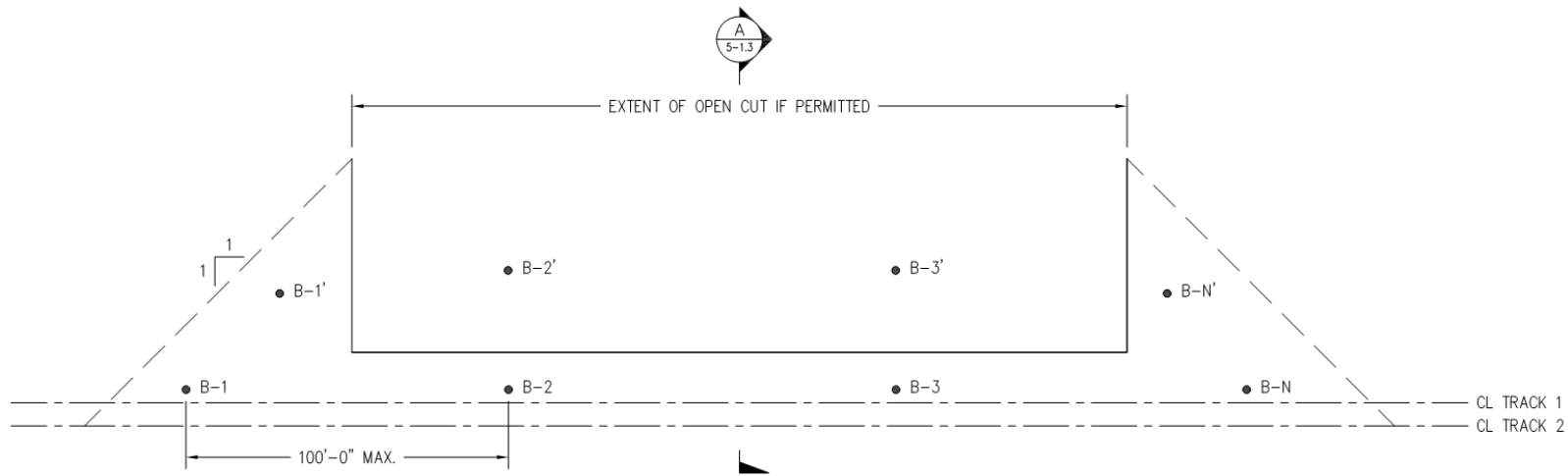

Figure 5 - 2: Typical Soil Boring Locations for Open Cut

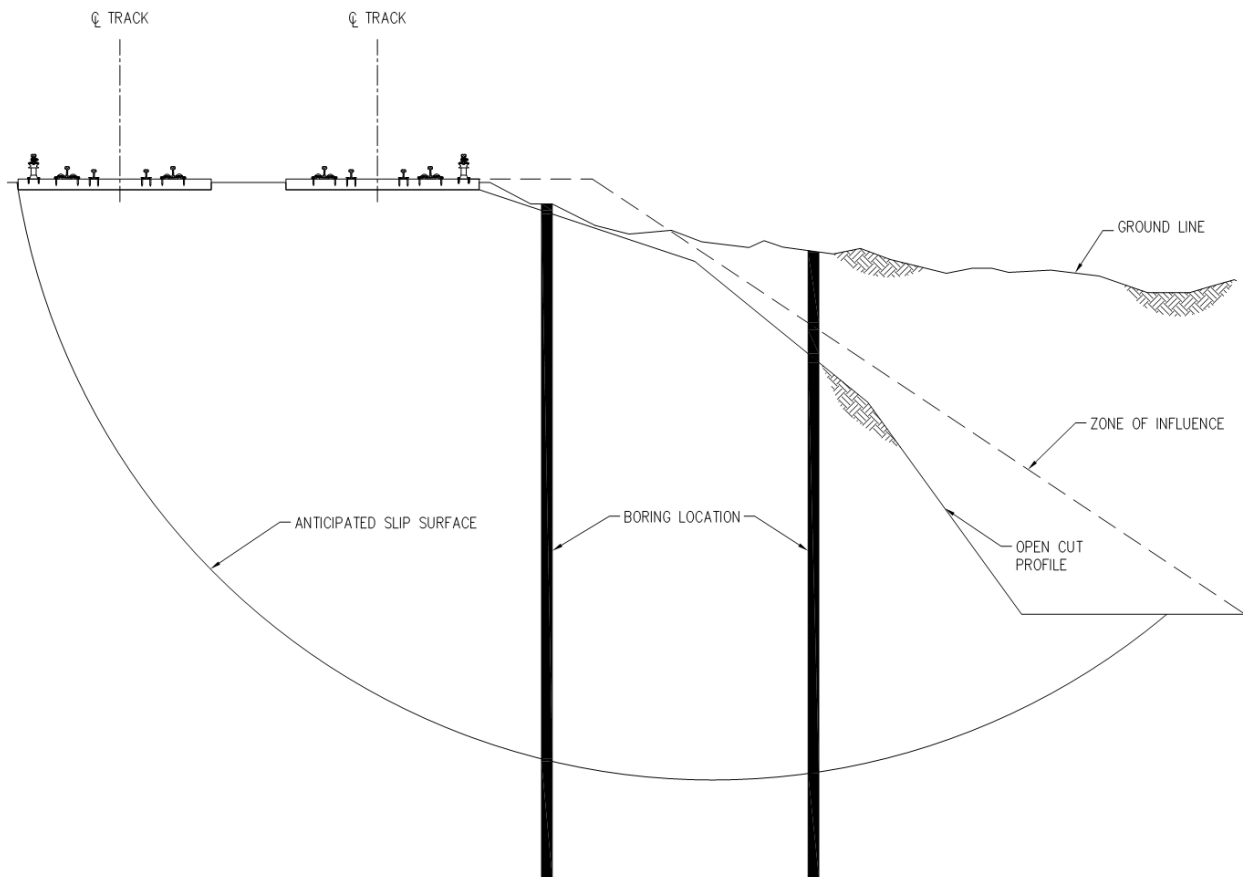

Figure 5 - 3: Section A for Open Cut



5.2.2 Loading from Retained Soil on Flexible Systems

The loading defined in this section applies to shoring systems that have some degree of flexibility. Shoring types that may be considered flexible include cantilever shoring walls and, in most cases, shoring walls supported by a single level of bracing. The active soil pressure distribution for a flexible shoring system shall be assumed to take the form of an equivalent fluid pressure (EFP); i.e., a triangularly shaped pressure distribution.

EFP values used for shoring design shall be ascertained by a Registered Geotechnical Engineer, or, alternatively, by a licensed Professional Engineer specializing in geotechnical engineering. In no case shall the design active EFP for soil above the groundwater table be less than 30 psf/ft for level retained earth when this approach is used (i.e., the active pressure at any depth shall not be less than $30(Y)$ psf where Y is a depth below the ground surface in feet)⁹. This minimum EFP value must be increased appropriately when the shoring system is retaining a sloped cut.

Alternatively, the retained soils may be classified as Type 3 in accordance with the soil descriptions in Table 8-5-1¹⁰ of the AREMA Manual for Railway Engineering. Representative soil properties for Type 3 classification are given in Table 8-5-2¹¹ of the AREMA Manual for Railway Engineering.

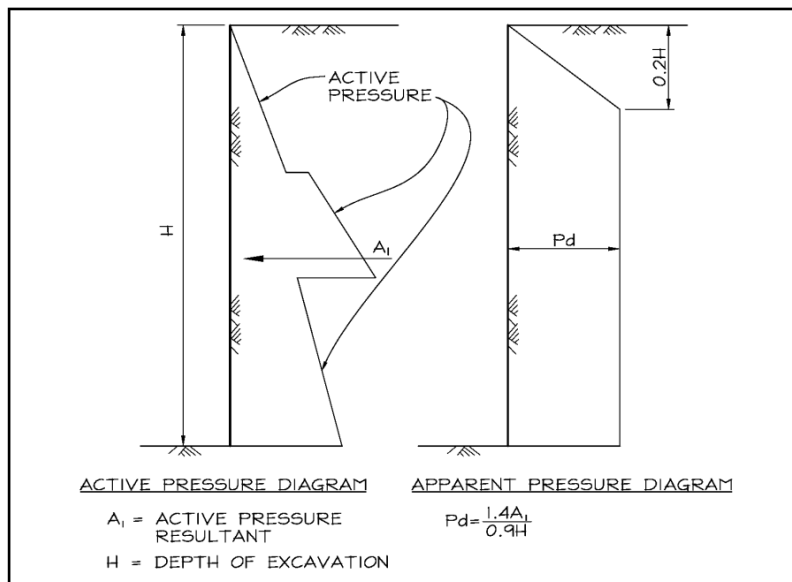

Figure 5 - 4: Construction of an Apparent Pressure Diagram

⁹See Section 5 Commentary

¹⁰See Section 5 Commentary

¹¹See Section 5 Commentary



5.2.3 Loading from Retained Soil on Restrained Systems

Shoring walls with multiple levels of bracing tend to restrict movements of the soil behind the wall. This restraint alters the soil pressure distribution from the anticipated pressures based on the theory of active loading. “Apparent pressure” diagrams for braced (restrained) shoring systems have been developed by numerous authors. Generalized apparent pressure diagrams suitable for use in both cohesionless and cohesive soils, as well as interlayered soil profiles, can be constructed from active pressure diagrams as shown in **Figure 5 - 4**.

Alternatively, a number of diagrams, applicable to either cohesionless or cohesive soils, or both, are presented in AREMA *Manual for Railway Engineering* Figure 8-28-2 (attached in Commentary Section for reference¹²), and in Chapter 7 of Caltrans *Trenching and Shoring Manual*¹³. These diagrams may be utilized, provided that the resulting loading magnitudes are not significantly less conservative than those determined by the procedure outlined in **Figure 5 - 4**.

When apparent pressure loading is utilized for design, active soil loading developed in accordance with [Section 5.2.2](#) shall be assumed to act below excavation grade.

5.2.4 Passive Resistance

Cohesionless Soil¹⁴

The passive resistance in cohesionless ($c = 0$) soils should be determined by Rankine’s Theory. When there are underground utilities that prevent sufficient embedment depth with the passive resistance calculated with Rankine’s Theory, log-spiral theory may be used. Determination of the coefficient of passive pressure (K_p) using log-spiral theory is a function of soil friction angle (Φ) and wall interface friction angle (δ). Previous railroad design criteria have required that δ be assumed to be 0° due to dynamic train loading. However, this assumption can produce overly conservative results (with $\delta = 0^\circ$, the calculated K_p with log-spiral theory is the same as using Rankine’s theory). In lieu of requiring $\delta = 0^\circ$, at the shoring designer’s option, δ_{design} may be assumed to be a maximum of $\delta_{\text{typ}}/2$, where δ_{typ} is the wall friction value that would be utilized in the design of typical shoring away from railroad tracks. In no case shall δ exceed $\Phi/4$.

Coulomb’s Theory to determine the passive resistance shall not be used.

Cohesive Soil

In cohesive ($\Phi = 0^\circ$) soil, $K_p = 1.0$, and the passive resistance is $\gamma_e z + 2c$, where γ_e is the effective unit weight of the soil (i.e., the moist unit weight above the water level and the buoyant unit weight below the water level) and z is a depth below excavation grade.

¹²See Section 5 Commentary

¹³*Trenching and Shoring Manual* by State of California, Department of Transportation, Issued by Offices of Structure Construction, Copyright © 2011 California Department of Transportation. All rights reserved.

¹⁴See Section 5 Commentary



Negative active pressures shall not be utilized to increase the available passive resistance under any circumstances. (Negative active pressures can be computed when $2c$ exceeds $\gamma_e H$, where H is the depth of excavation.)

Cohesive (c), and Granular (Φ) Soil

Passive pressure diagrams can be developed for c , Φ soils using more complex theoretical expressions. However, it is common to consider a soil stratum as either a purely cohesionless or cohesive soil depending on the soil's predominant physical properties and expected behavior.

Effect of Unbalanced Water Head

In cases where the shoring system will retain an unbalanced water head, available passive resistance may need to be reduced to account for upward seepage pressures.

5.2.5 Wall Rotation

When the actual estimated wall rotation is less than the value required to fully mobilize active or passive conditions, adjust the earth pressure coefficients by using the diagram on the upper right-hand corner of **Figure 5 - 5**.

5.3 GROUNDWATER LOAD

Groundwater loading acting on the shoring system shall be based upon the maximum groundwater level that can be reasonably anticipated during the life of the shored excavation.

The design groundwater table shall be established upon available historical ground water monitoring (well) data and/or boring data for the subject area. For projects where historical records are not available, the groundwater table utilized for design shall be assessed conservatively by choosing the higher elevation between the groundwater elevation when drilling (WD) and the groundwater elevation after boring (AB) plus five (5) feet. Alternatively, a groundwater monitoring well would need to be installed and collected for one year to document highest potential water elevation.

5.4 SURCHARGE LOADS

Lateral pressure acting on the temporary shoring system resulting from the following sources of surcharge loading shall be considered in the design of the shoring as appropriate:

- Rapid transit live load (see [Section 6](#))
- Casing pipe for Jack-and-Bore construction shall be designed with an impact factor of 35% applied to the Rapid Transit live load surcharge specified in [Section 6.1](#) if the height of soil cover is less than 10 feet.
- Track, ties, and ballast (where not included in soil loads)
- Equipment and vehicles
- Material stockpiles



- Existing structures
- Shoring tower
- Any other source of surcharge load
 - For Jack-and-Bore construction, the boring machine requires backplate or reaction piles to drive the casing. If the backplate or reaction piles are to be mounted on the ERS system, the pressure from the boring machine exerting on the ERS system shall be included in the design. The pressure used in the design shall be monitored during Jack-and-Bore construction.

Lateral pressure resulting from vertical surcharge loads shall be computed in accordance with the equations presented in Article 20.3.2 of the AREMA *Manual for Railway Engineering* Chapter 8 – Concrete Structures and Foundations.

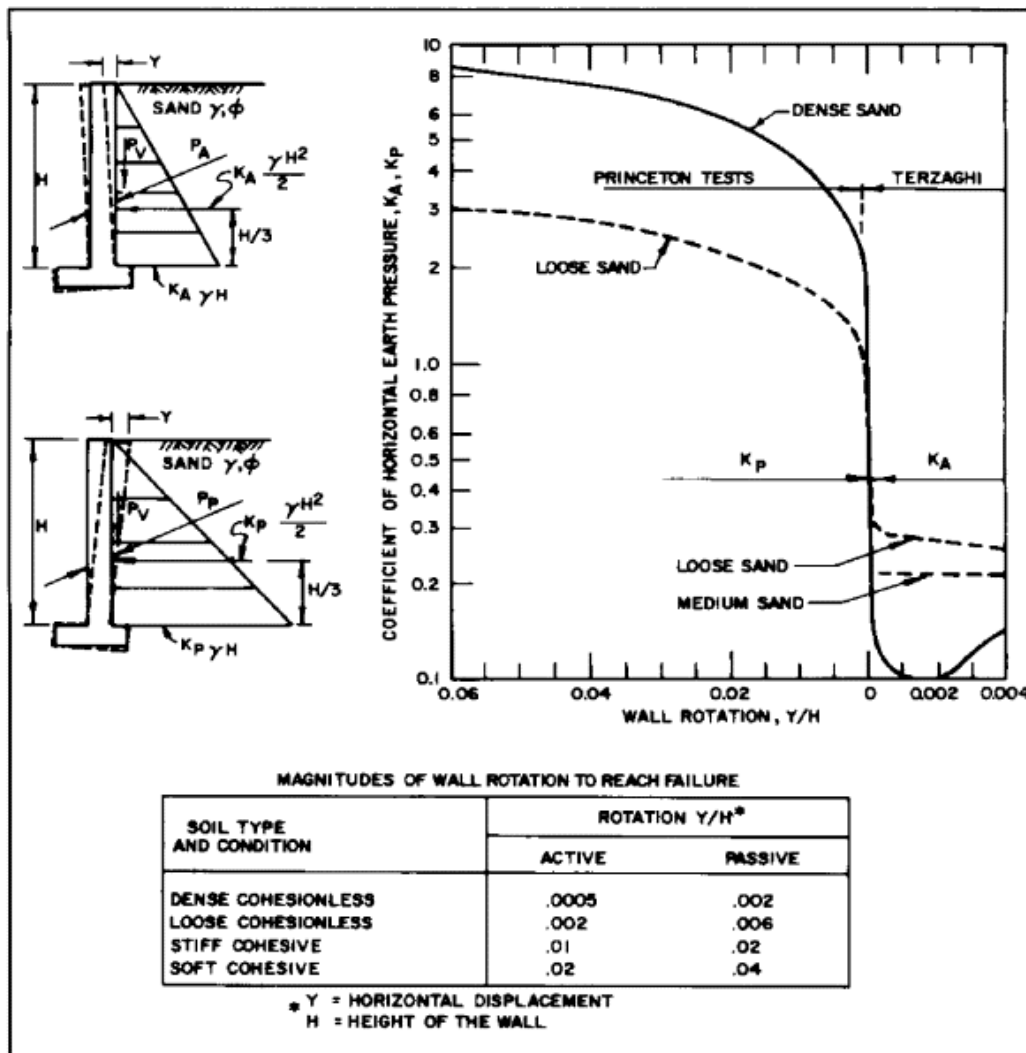

Figure 5 - 5: Effect of Wall Movement on Wall Pressures



5.5 EARTHQUAKE (SEISMIC) LOAD

Special provisions for seismic design shall not apply.

5.6 COMBINATION OF LOADS AND LOADING CASES

All elements of the temporary shoring system shall be designed for a combination of lateral soil, groundwater, and surcharge loads acting in conjunction with vertical dead and live loads. Load combinations shall be per AREMA *Manual for Railway Engineering* Table 8-2-4 for Service Load Design, or Table 8-2-5 for Load Factor Design.

Loading conditions during all stages of excavation, support removal, and support relocation shall be analyzed. No reduction in loading from the present during the full depth excavation stage shall be assumed for the stages of support removal or relocation.

In situations where loading conditions on opposite sides of an internally braced excavation are not equal, the shoring design shall account for this unbalanced loading condition. The shoring system shall be designed for, and be compatible with, the more heavily loaded side of the excavation.

In situations where the top of shoring wall elevation on opposite sides of an internally braced excavation is not equal and the soil is re-graded, the shoring design shall account for the global stability.



SECTION 6 RAPID TRANSIT LIVE LOAD SURCHARGE

6.1 GENERAL

All temporary shoring systems supporting excavation within the Zone of Influence and sloped excavations beyond Zone of Influence (see [Section 3.1](#)) shall be designed for lateral pressure due to rapid transit live load surcharge unless otherwise approved by CTA under [Section 3.3](#). Transit live load surcharge, specified below, shall be based on CTA Rapid Transit Axle Loads – Normal Service, unless otherwise directed by CTA to use the CTA Railbound Crane Axle Loads. In cases where CTA shares Right-of-Way with private railroad owners, the railroad live load surcharge shall be based on Cooper’s E-80 live load, or as directed by the railroad owner. In no case shall the railroad live load surcharge used in the design be smaller than the CTA Rapid Transit live loads. No reduction in lateral surcharge pressure shall be allowed for “flexible” or “semi-rigid” wall behavior (i.e. 100% Boussinesq live load surcharge for “rigid” wall behavior is required for design of all shoring wall types).

Lateral surcharge pressure values for various depths below bottom of tie and distances to centerline of track computed using the Boussinesq equation are provided in **Figure 6 - 1** and are from AREMA *Manual for Railway Engineering* Chapter 8 – Concrete Structures and Foundations Part 20 Flexible Sheet Pile Bulkheads Article 20.3.2.2 Strip Load q.

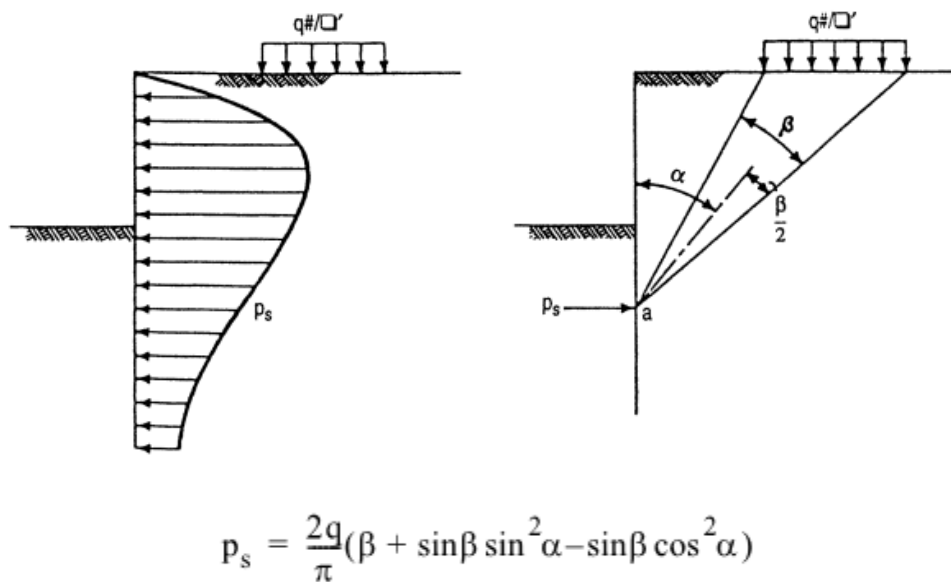

Figure 6 - 1: Pressure Distribution for Strip Load

Where, strip load q for CTA Rapid Transit Axle Loads – Normal Service is¹⁵:

¹⁵See [Section 6 Commentary](#)



$$q_{normal} = 491psf$$

Strip load q for CTA Railbound Crane Axle Loads is¹⁶:

$$q_{crane} = 606psf$$

Strip load for Cooper's E-80 live load can be calculated as:

$$q_{E-80} = 80,000 / (5 \cdot 9) = 1779psf$$

For stability check for old existing retaining walls supporting CTA tracks built prior to 1970, if the factor of safety for overturning and sliding cannot achieve the requirements as shown in [SECTION 7](#), submit a Variance Request with the calculations showing factors of safety cannot achieve the requirements within this Manual for review and additional considerations as shown in the Commentary¹⁷.

The values shown above were calculated by the dividing axle loads by the product of tie length (standard 9 ft tie) and shortest axle spacing (i.e. the strip load width shall be 9.0 feet). The values developed for the standard concrete tie length of 8.25 feet are not meaningfully different from those presented above. Note that the provided values apply only for situations where the top of shoring is at or above the elevation of the bottom of railroad ties.

The values shown above do not contain weight of track system and it shall be included in the design. The weights of different track types are shown below, there shall be no reduction in the retained soil for the volume of ties. Pressures can be obtained by dividing the values by the standard long 9 ft ties.

- Tangent Track 460 lbs. / ft. / track
- Curved Track without Restraining Rail 500 lbs. / ft. / track
- Curved Track with Restraining Rail 570 lbs. / ft. / track

The following examples are located in Appendix C.

[Example 6.1 Rapid Transit Live Load Surcharge from Two Tracks](#)

[Example 6.2 Rapid Transit Live Load Surcharge from Three Tracks](#)

[Example 6.3 "Simplified" Rapid Transit Live Load Surcharge from Four Tracks](#)

[Example 6.4 Construct the Actual Rapid Transit Surcharge Pressure](#)

6.2 SURCHARGE FROM MULTIPLE TRACKS

Surcharge loading from multiple tracks shall be considered as follows:

- Two tracks – Full surcharge from both tracks.
- Three tracks – Full surcharge from two closest tracks combined with 50% surcharge from third track.

¹⁶See Section 6 Commentary

¹⁷See Section 6 Commentary



- Four or tracks – Full surcharge from two closest tracks combined with 50% surcharge from third track and 25% surcharge from fourth track.

Only surcharge from those tracks for which the shored excavation is within the Zone of Influence need be considered.¹⁸

6.3 SIMPLIFIED SURCHARGE PRESSURE DISTRIBUTION

In lieu of using the detailed Boussinesq pressure distribution, railroad live load surcharge pressures may be simplified to have a rectangular distribution with a magnitude equal to 80% of the maximum Boussinesq pressure as simplified surcharge pressure distribution. The simplified surcharge pressure distribution is permitted in braced condition in all Zones and cantilevered condition in Zone 4. Further, the simplified surcharge pressure distribution will be permitted in the cantilevered condition for sheet piling in Zone 2, and the cantilevered condition for soldier piles (and sheet piling) in Zone 3 provided the maximum cantilevered height limits are satisfied. For multiple level braced shoring wall, before the second level of bracing can be installed, this condition may be the critical condition for the design. The Designer in Responsible Charge shall evaluate if simplified surcharge pressure can be used to calculate the stage 1 bracing reaction. In no cases shall the simplified surcharge pressure distribution result in lower demands in any structural elements in a shoring wall system.

6.4 APPLICATION OF SURCHARGE PRESSURE

Railroad live load surcharge pressures shall be assumed to act over the full height of the temporary shoring wall. Where the top of the shoring wall is at or above the bottom of railroad tie elevation, the vertical surcharge pressure (q) used in the Boussinesq distribution shall be the pressure under the ties and shall be applied starting at the bottom of crosstie elevation. Where the top of the shoring wall is below the bottom of railroad tie elevation, the vertical surcharge pressure used in the Boussinesq distribution shall be an equivalent pressure at the top of the shoring wall. The equivalent vertical surcharge pressure shall be distributed over a length equal to the tie length plus the vertical distance from bottom of tie to top of wall (1H:2V distribution outward from each end of the tie). The magnitude of the equivalent vertical surcharge (q) will be equal to the pressure under the tie multiplied by the ratio of the tie length to the equivalent distributed length.

6.5 SURCHARGE FOR PERPENDICULAR SHORING WALLS IN ZONE 1

Temporary shoring walls proposed to be installed perpendicular to and across tracks (or used as temporary bridge abutments) will not be allowed, unless otherwise specially permitted by CTA. If special permission is granted by CTA, the design railroad live load surcharge acting on such walls shall be computed in accordance with Chapter 8, Article 5.3.1 of the *AREMA Manual for Railway Engineering*.

¹⁸[See Section 6 Commentary](#)



6.6 COMBINATION WITH SURCHARGE FROM OTHER SOURCES

Surcharge from other sources (e.g., heavy equipment, existing structures, etc.) shall be considered in the design of temporary shoring systems for excavation support as appropriate. Surcharges from other sources shall be added to the railroad live load surcharge if the surcharge loads can act concurrently. An example of combined surcharges may be Contractor cranes, trucks, or material stockpiles above an excavation concurrent with a passing train. The minimum construction surcharge shall be 240 psf unless a heavier equipment is anticipated.



SECTION 7 SHORING ANALYSIS METHODOLOGIES

Classic shoring analysis methodologies are summarized in Section 7 and should be considered minimum analysis requirements for temporary shoring design. Computer programs and more advanced soil-structure interaction analyses may be utilized for design, but shall be accompanied by verified hand calculations showing significant agreement with the classic methodologies presented herein. The Engineer in Responsible Charge shall be solely responsible for input and results of computer programs utilized for shoring analysis and design. See [Section 2.4](#) for additional information on submittal of computer program output as part of the design calculations.

Typical temporary shoring applications may not require stability analysis beyond determining the minimum embedment. The factor of safety against sliding, overturning and global slope stability shall be calculated as applicable to the particular temporary shoring system. The minimum factor of safety for stability, including sliding, overturning and global slope stability, shall be 1.5. No reduction for factor of safety is allowed for temporary condition. See [Section 9.4](#) for global stability analysis requirements.

The following example is provided in Appendix C:

[Example 7.1 Cantilever Soldier Pile and Lagging Shoring Wall](#)

The following examples will be provided in future revisions:

- Example 7.2 Sheet Pile Shoring Wall, One Level of Bracing (Free Earth Support Method)
- Example 7.3 Sheet Pile Shoring Wall, One Level of Bracing (Fixed Earth Support Method)
- Example 7.4 Analysis of a Diaphragm Shoring Wall with Three Levels of Bracing

7.1 CONTINUOUS SHORING WALLS

Continuous shoring walls, such as steel sheet piling and diaphragm walls, are typically analyzed on a longitudinal per-foot-of-wall (unit) basis for the lateral pressures computed in accordance with [Sections 5](#) and [Section 6](#) of this Manual. The wall is designed for the unit bending moments and shears resulting from the lateral pressures acting on the wall. When the shoring wall is designed to support vertical loads, these loads must be considered in the design as well.

In the case of sheet piling, the structural strength of the wall is provided by sheets themselves. Wide flange sections installed in deep soil mix, secant, tangent, or slurry walls are the primary structural elements for these systems. Rebar reinforced slurry walls are designed as a continuous vertically reinforced concrete wall.

7.2 SOLDIER PILE SHORING WALLS

Soldier pile and lagging walls are analyzed in a somewhat different manner than continuous shoring walls. Soldier pile and lagging walls are not continuous below excavation grade, and the loading acting on the active and passive sides of the wall for the embedded portion of the wall



must be constructed to reflect the discontinuous nature of the wall. The “effective width” of the embedded portion of the soldier pile (for both active and passive loading)¹⁹ shall follow the requirements per AREMA *Manual for Railway Engineering* Chapter 8 Part 28 Article 28.5.3.2 where it requires the equivalent width shall be assumed to equal the width of the soldier pile multiplied by a factor of 3 for granular soils and a factor of 2 for cohesive soils. The width of the soldier piles shall be taken as the width of the flange or diameter for driven sections and the diameter of the concrete-filled hole for sections encased in concrete. When determining the passive pressure distribution on the soldier piles, a depth of 1.5 times the width of the soldier pile in soil shall not be considered in providing passive lateral support. As with continuous walls, lateral pressures utilized to construct the loading diagrams shall be computed in accordance with [Sections 5](#) and [Section 6](#) of this Manual.

Soldier piles are designed as vertical beams to resist the bending moments and shears resulting from the lateral loads acting on the piles. Vertical loading (if any) shall be considered in the soldier pile design.

7.3 ANALYSIS OF CANTILEVER WALLS

Cantilever shoring walls shall be designed using the “Conventional Methods” of analysis. A schematic figure showing the resulting active and passive pressures is provided in Figure 8-28-1 in AREMA *Manual for Railway Engineering* for cohesionless soil, as shown below. The rotation of the length of vertical wall element shall be considered as the soil will be mobilized below the point of rotation on the retained soil side of the ERS wall (i.e., Pp2 as passive pressure, Pa2 as active pressure.)

Alternatively, cantilever walls may be designed using the “simplified” method where the rotation of the length of vertical wall element is ignored (i.e., Pp2 and Pa2 are ignored). If this method is used, the computed embedment depth (referred to as “D – Z” in the above referenced Figure 8-28-1) shall be increased by 20 percent to determine the minimum theoretical embedment depth.²⁰

A factor of safety for the cantilever wall embedment shall be provided. When the theoretical embedment depth is computed based on the “unreduced” passive resistance (factor of safety equals to 1.0), this theoretical embedment depth shall be increased by a minimum of 40% to determine the design embedment depth (i.e. minimum factor of safety on theoretical embedment depth of 1.4)²¹. This 40% increase is provided in addition to the 20% increase required if the “simplified” method of analysis has been utilized.

¹⁹See [Section 7 Commentary](#)

²⁰See [Section 7 Commentary](#)

²¹See [Section 7 Commentary](#)

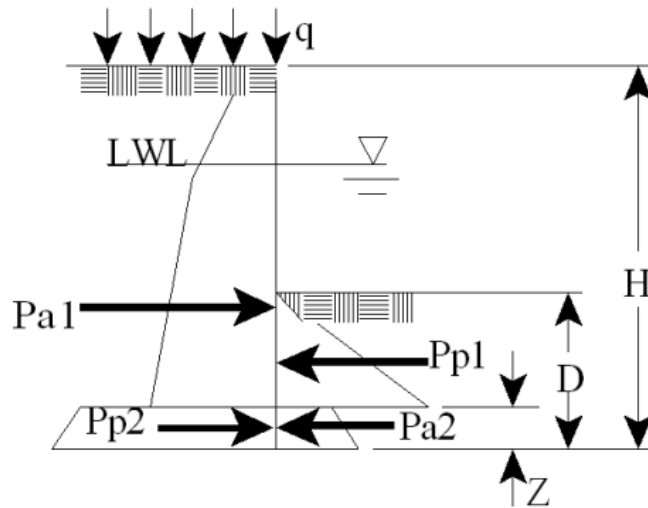

Figure 8-28-1. Lateral Earth Pressure - Granular Soil

Embedment depths computed based on passive resistance that has been reduced by a factor of safety of 2 will also be acceptable, provided that the resulting embedment depth is not significantly less than that computed using the nominal 40% increase in embedment depth discussed above.

Analysis utilizing “unreduced” passive resistance should be applied with caution when the shoring wall is embedded in stiff to hard clays, because the computed embedment may be unrealistically short. See [Section 7.8.1](#) for minimum embedment depths.²²

7.4 ANALYSIS OF WALLS WITH A SINGLE LEVEL OF BRACING

Walls supported by a single level of bracing may be analyzed using the Free Earth Support or Fixed Earth Support Method at the shoring designer’s option. Each of these methods is outlined below.

7.4.1 Free Earth Support Method

This method is based on the assumption that the shoring wall is embedded far enough to assure stability, but that the available passive resistance is incapable of restraining the shoring wall sufficiently to induce negative moment in the wall (i.e., there is no reversal of moment below excavation subgrade). The theoretical embedment required for stability is determined by statics. The theoretical depth of embedment required is determined by summing moments due to all pressures acting on the shoring wall about the bracing level. The embedment depth is adjusted until the sum of the moments about the bracing level is zero. Moments and shears in the shoring wall and the bracing reaction may be computed after the embedment depth is determined.

²²See [Section 7 Commentary](#)



7.4.2 Fixed Earth Support Method

This method is based on the assumption that the shoring wall is embedded sufficiently to provide effective “fixity” at the bottom of the shoring wall (i.e., the deflected shape of the shoring wall is such that the wall reverses curvature over its embedded length and becomes vertical at its bottom). Unlike the Free Earth Support Method, moment reversal takes place over the embedded portion of the shoring wall. In comparison to the Free Earth Support Method, the embedment computed using the Fixed Earth Support Method would be longer; however, pile moment demand, pile deflection, and the bracing reaction will typically be reduced.

Hand calculating the required embedment depth for the Fixed Earth Support Method is not a trivial matter. However, through the use of commonly available structural analysis software, determining the depth of embedment required to produce the appropriate deflected shape of the shoring wall (i.e., effective fixity) is just a matter of iterating the depth of embedment. As for the Free Earth Support Method, moments and shears in the pile, and the bracing reaction may be computed after the theoretical embedment depth is determined.

7.4.3 Factor of Safety for Shoring Wall Embedment Depth

A factor of safety for the shoring wall embedment depth must be provided when either the Free Earth Support Method or Fixed Earth Support Method is used. The requirement shall be the same as outlined in [Section 7.3](#).

In Appendix C, Example 6.2 illustrates the Free Earth Support Method and Example 6.3 illustrates the Fixed Earth Support Method for the same excavation geometry in the same soil conditions for comparison purposes. (Examples will be provided in the future revision).

7.5 ANALYSIS OF WALLS WITH MULTIPLE LEVELS OF BRACING

7.5.1 Embedment Depth

The required depth of penetration for a shoring wall supported by two or more levels of bracing shall be determined by one of the following methods (See [Section 7.8.1](#) for minimum embedment depths.):

1. The theoretical embedment may be calculated by balancing moments due to all soil, hydrostatic, lateral surcharge, and “unreduced” passive pressures (factor of safety equal to 1.0) acting below the lowest bracing level about the lowest bracing level. The moment capacity of the shoring wall shall be conservatively neglected in this analysis. The depth of penetration is adjusted until the sum of the moments equals zero. The computed theoretical embedment depth shall be increased by a minimum of 50% to determine the design embedment depth. (This method should be used with caution when stiff to hard clays provide passive resistance, because the computed embedment depth may be unrealistically short.)



2. The embedment depth may be computed by summing moments as noted above, using passive resistance values that have been reduced by dividing them by a factor of safety of 2.0. No increase in embedment is required when this method is used. This method will be acceptable provided that the resulting embedment depth is not significantly less than that computed using the nominal 50% increase in embedment depth discussed above.

7.5.2 Analysis of Shoring Wall

Moments and shears in the shoring wall shall be computed using beam analysis, assuming that the shoring wall is hinged at all bracing levels except the uppermost.²³ Analysis of the portion of the shoring wall below the lowest bracing level shall be based on statics, including a consideration of all loads acting on the embedded portion of the shoring wall. A fictitious support at or below subgrade shall not be assumed for analysis purposes.

No redistribution of loads or reduction in the demand on the shoring wall due to soil arching shall be assumed.

7.5.3 Determination of Bracing Loads

Bracing loads shall be determined by beam analysis assuming that the shoring wall is hinged at all the bracing levels except the uppermost.

The load on the lowest bracing level shall be determined by statics, including a consideration of all loads acting on the embedded portion of the shoring wall. A fictitious support at or below subgrade shall not be assumed for analysis purposes.

7.6 ANALYSIS BRACING SYSTEMS

Unit (per foot) reactions at each bracing level are determined during the analysis of the shoring wall. For shoring walls with soldier piles (e.g., soldier pile and lagging walls, deep soil mix walls, and secant walls) point loads from each pile are computed by multiplying the pile spacing by the unit bracing reactions. Bracing loads for sheet piling may be assumed as a horizontal uniform load equal to the unit reactions.

Internal (cross-lot) bracing systems consisting of wales and struts shall be designed to resist the computed bracing loads. Moments, shears, and axial loads in the bracing members shall be computed using standard methods of structural analysis.

Tieback is a prohibited shoring type per [Section 4.3](#). However, when permitted to use, tieback or deadman systems that are used to restrain the shoring walls shall be designed to resist the computed bracing loads.

²³[See Section 7 Commentary](#)



No redistribution of loads or reduction in the demand on bracing elements due to soil arching shall be assumed.

7.7 LAGGING ANALYSIS

Lagging may be designed for a load equal to two third of the shoring design load (soil and surcharge pressures) to account for soil arching when arching action can form in the soil behind the lagging (e.g., in granular or stiff cohesive soils where there is sufficient space to permit the in-place soil to arch and the back side of the soldier piles bear directly against the soil). The lagging members shall be designed as horizontal beams spanning between soldier piles.

In cases where soil arching cannot develop, reduced lagging loads shall not be considered.

Tabulated lagging thicknesses (such as FHWA *Lateral Support Systems and Underpinning RD 75-128* Table 4 – Recommended Thicknesses of Wood Lagging) shall not be utilized.

7.8 GENERAL SHORING REQUIREMENTS

7.8.1 Minimum Embedment Depth

Computed embedment depths shall be compared with the following minimum values. In cases where the computed embedment depth is less than that specified below, the minimum embedment depth specified below shall be utilized:

- Cantilever walls: Embedment depth shall not be less than the height of the retained cut.²²
- Braced walls less than 20 feet high: Embedment depth shall not be less than 6 feet.²⁴
- Braced walls 20 feet high or more: Embedment depth shall not be less than 8 feet.²⁴

7.8.2 Secondary Bracing

Primary elements of the shoring system shall be provided with secondary bracing as required for stability. The secondary bracing elements shall be designed for an axial load equal to 2.5% of the axial load in the braced member.²⁵

7.8.3 Connections

Connections between the various elements of the shoring system shall be designed for tension and shear loads equal to at least 10% of the design compression load transferred through the connection. If the actual shear or tension at a connection is larger than this 10% value, then the actual shear or tension load shall be utilized for design.

²⁰See Section 7 Commentary

²⁴See Section 7 Commentary

²⁵See Section 7 Commentary



The connection from a strut to a soldier pile or waler shall not be a single gusset/knife plate.²

7.8.4 Stiffeners

Stiffeners shall be provided at shoring member connections per AREMA *Manual for Railway Engineering* Chapter 15 Article 1.7.7 – Stiffeners at Points of Bearing. Stiffener thickness shall not be less than 3/8”.

7.8.5 Splices

Splice of steel members shall have a strength not less than the capacity of the member being spliced.

7.8.6 Welding

All field welding on the earth retention structures within the Zone of Influence shall comply with AWS D1.1, unless otherwise noted for any shoring structures directly supporting CTA track structures and CTA train loadings, which AREMA and AWS D1.5 shall be used, especially those members in tension designated as Fracture Critical Members. Welder's Qualification and Certificates, and all Welding Procedure Specifications for the welds used in the field for the temporary structures mentioned above, shall be submitted, and included in the Construction Process Plan for review and record.

7.9 SHORING DEFLECTION AND SETTLEMENT

All shoring designs within the Zone of Influence shall include an estimate of shoring deflection and retained earth settlement. Maximum permissible deflection shall enable the horizontal and vertical movement of the track to be limited to the requirements of [Section 10.2](#). The amount of settlement that occurs will depend upon the soil type, the size of the excavation, the construction methods and quality of workmanship, and the design of the shoring system (including the stiffness of the shoring wall and bracing systems).

Elastic analyses of the shoring system should be performed for the various stages of support installation and removal in order to estimate lateral shoring deflection, which should then be used to make settlement estimates. It is important to understand that the shoring system deflections in different stages are additive (i.e., stage 1 deflection can be added to stage 2 deflections to estimate the overall final deflection, and waler deflection at the mid span can also contribute to the deflection of the overall system and affect the settlement.)²⁶

Unless structural analysis show a greater elastic deflection of the shoring wall will not cause excessive ground settlement, the following shoring wall deflection limit shall be used for design:

²See [Section 1 Commentary](#)

²⁶See [Section 7 Commentary](#)



1. For shoring wall in Zone 2 and Zone 3 of **Figure 3 - 1**, maximum deflection at top of the shoring wall shall be 1/4".
2. For shoring wall in Zone 4:
 - a. Horizontal distance from shoring wall to center line of track measured at a right angle from track is greater than 12' but smaller than 18', maximum deflection at top of shoring wall shall be 3/8".²⁷
 - b. Horizontal distance from shoring wall to center line of track measured at a right angle from track is greater than 18', maximum deflection at top of shoring wall shall be 1/2".²⁷

When excavation is in soft to medium clays, bottom heave must be considered per [Section 9.3.2](#). In addition to the shoring wall elastic deflection calculation, lateral wall movement shall also be determined using **Figure 7 - 1** as a comparison and the greater deflection shall be used for the ground settlement analysis.

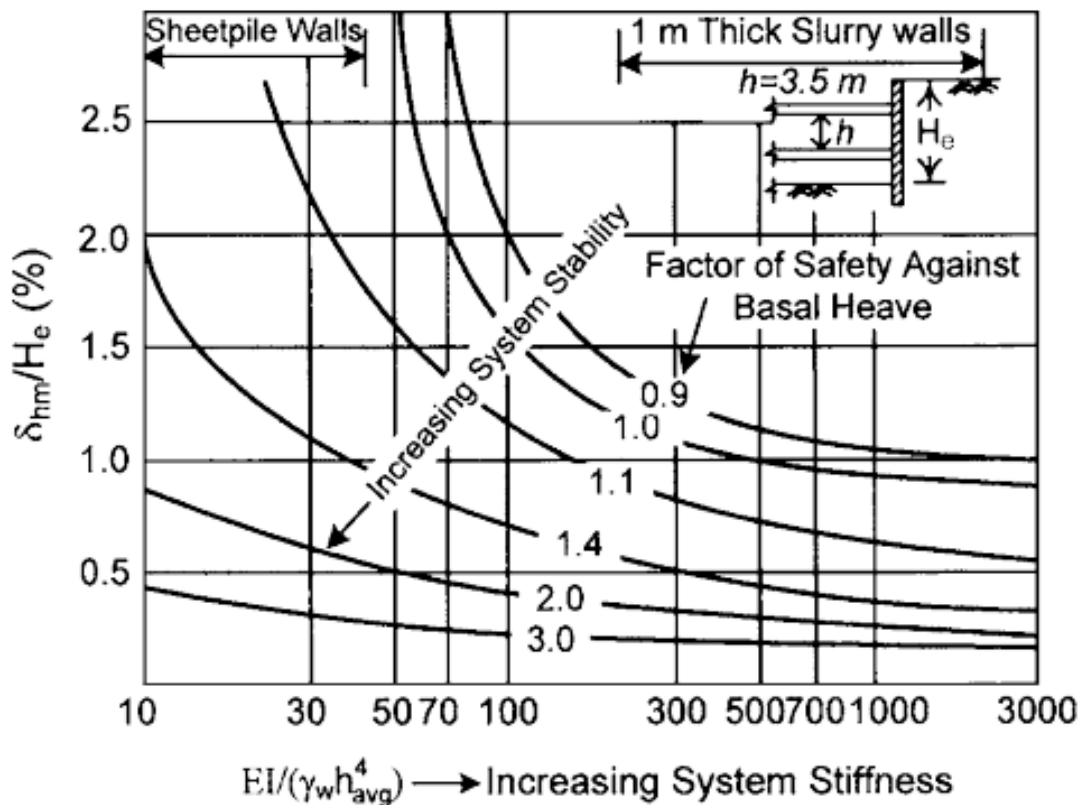

Figure 7 - 1: Design Curves for Maximum Lateral Wall Movement for Excavations in Soft to Medium Clays (Clough and O'Rourke 1990)

²⁷See Section 7 Commentary



SECTION 8 MATERIAL PROPERTIES AND ALLOWABLE STRESSES

The following examples are provided in Appendix C:

[Example 8.1 Wide Flange Waler Design](#)

[Example 8.2 Pipe Strut Design](#)

[Example 8.3 Shoring Wall Design](#)

[Example 8.4 Wood Lagging Design](#)

8.1 STEEL

Steel may be used material, provided that is free from any strength impairing defects or contain permanent deformations.

8.1.1 Structural Steel

Allowable stresses for steel shall conform to the AREMA *Manual for Railway Engineering* Table 15-1-11, latest edition, with the following additional constraints for struts or any members stressed primarily in axial compression:

- Axial stress shall not exceed 12 ksi.²⁸
- Round HSS members will be allowed even though they are not included in the AREMA *Manual for Railway Engineering*. Round HSS members used as struts shall be designed per AREMA and AISC as shown in [Example 8.2 in Appendix C](#).

Structural steel design, including bolted and welded connections design shall conform to the AREMA *Manual for Railway Engineering* Chapter 15 Steel Structures Part 1 Design, except for the provisions for fatigue requirements.

No overstress shall be permitted.

Structural steel for which mill certificates are not available (unidentified steel) shall be designed for allowable stresses no greater than those allowed for ASTM A36 steel.

The design wall thickness shall be taken to 0.93 times the nominal wall thickness for ASTM A500 shapes, regardless the welding process.

Preferred Material Specification – American Society for Testing and Materials (ASTM)

- ASTM A6 “Standard Specification for General Requirements for Rolled Structural Steel Bars, Plates, Shapes, and Sheet Piling”

²⁸[See Section 8 Commentary](#)



- ASTM A36 “Standard Specification for Carbon Structural Steel” for all shapes other than W and HP
- ASTM A572 “Standard Specification for High-Strength Low-Alloy Columbium-Vanadium Structural Steel” Grade 50 for HP shape
- ASTM A992 “Standard Specification for Structural Steel Shapes” for W shape used as structural components for earth retention system (i.e., soldier piles, walers, struts)
- ASTM A709 “Standard Specification for Structural Steel for Bridges” for W shape used as structural components for elevated track supporting temporary shoring structures as governed by [Section 11.4](#)
- ASTM A500 “Standard Specification for Cold-Formed Welded and Seamless Carbon Steel Structural Tubing in Rounds and Shapes” Grade B for HSS shapes
- ASTM A252 “Standard Specification for Welded and Seamless Steel Pipe Plies” Grade 2 or better for HSS shapes.
 - If the casing is to be welded for splicing, the carbon equivalency (CE) as defined in AWS D1.1, Section XI 5.1, shall not exceed 0.45, and the sulfur content shall not exceed 0.05 percent.
 - The design wall thickness shall be taken to 0.93 times the nominal wall thickness for ASTM A252, regardless the welding process.

8.1.2 Steel Sheet Piling

The maximum allowable flexural stress in sheet piling shall not exceed 65% of the yield strength of the steel and overstress shall not be permitted.²⁹

Hot-rolled sheet piling is preferred than cold-rolled sheet piling. If cold-rolled sheet piling is used for the shoring wall, the section property shall be reduced by 10% for design.³⁰ (Refer to [Example 8.3](#))

Preferred Material Specification – American Society for Testing and Materials (ASTM)

- ASTM A328 “Standard Specification for Steel Sheet Piling” Grade 50 or ASTM A572 Grade 50 for hot rolled steel sheet piling
- ASTM A572 Grade 50 for cold-rolled sheet piling

²⁹[See Section 8 Commentary](#)

³⁰[See Section 8 Commentary](#)



8.1.3 Prestressed Strand or Rod

If prestressed strands or rod are used as tieback tendons (special CTA approval required, refer to [Section 4.3](#)) or as tie rods to a deadman, the allowable working stress shall not exceed 40% of the guaranteed ultimate tensile strength. All tiebacks shall be load tested, refer to [Section 9.5](#) for tie back testing requirements.

If the strands or rod are used for purposes other than those specified above, the allowable working stress shall not exceed 60% of guaranteed ultimate tensile strength.

The shoring designer shall evaluate the potential effects of corrosion on strands and rods and take necessary cross section reduction in design, and provide corrosion protection suitable for the installation environment and anticipated service life.

Preferred Material Specification – American Society for Testing and Materials (ASTM)

- ASTM A416 “Standard Specification for Low-Relaxation, Seven-Wire Steel Strand for Prestressed Concrete”
- ASTM A722 “Standard Specification for High-Strength Steel Bars for Prestressed Concrete”

8.1.4 Wire Rope Cable and Chain

Wire rope cables and chains shall not be used.³¹

8.1.5 Casing Pipe

For Jack and bore carrier pipe carrying flammable material and other hazardous material, casing pipe and joints shall be of metal and of leakproof construction.

The minimum yield strength for steel pipe will be 35 ksi. Smooth wall pipes with a nominal diameter greater than 70 inches require special approval by the CTA. See [Appendix D](#) for Table of Minimal Wall Thickness for Steel Casing Pipe.

Preferred Material Specification – American Society for Testing and Materials (ASTM)

- ASTM A252 “Standard Specification for Welded and Seamless Steel Pipe Piles” Grade 2 or better

8.1.6 Micropile Casing Pipe³²

Micropile casing pipe shall have physical properties conform to one of the following:

³¹[See Section 8 Commentary](#)

³²[See Section 8 Commentary](#)



Preferred Material Specification:

- API 5CT Grade N80 or better. Casings shall not be spliced with welded joints.

8.2 CONCRETE³³

Reinforced and plain (unreinforced) concrete shall be designed using the Service Load Design in accordance with AREMA *Manual for Railway Engineering* Chapter 8 Part 2 Article 2.25 through Article 2.29. Service Load Design load combinations shall be used in Table 8-2-4 in AREMA *Manual for Railway Engineering*.

Load Factor Design in accordance AREMA *Manual for Railway Engineering* Chapter 8 Part 2 Article 2.30 through Article 2.39 is also accepted provided all applicable loads are factored per Table 8-2-5 in AREMA *Manual for Railway Engineering*.

No stress increases or load factor reductions shall be allowed.

8.2.1 Non-Shrink Grout

A mixture of Portland Cement, admixture, and water. Grout must have a 28-day strength of 5,000 psi when tested in accordance with ASTM C109. The grout must consist of a neat cement or sand cement mixture of Type II, III or V Portland cement conforming to Section 1020 of the IDOT Standard Specifications.

8.3 WOOD

All wood shoring elements shall be Douglas Fir, No. 2 or better if below allowable stresses are used. Other species and grades are also acceptable. The allowable stresses shall be determined based on NDS.

All wood that will remain in place permanently, if permitted by CTA, shall be pressure treated for ground contact use in accordance with AWPA U1, User Category UC4B or UC4C.

Allowable stresses shall be as follows:

Compression perpendicular to the grain = 450 psi

Compression parallel to the grain = $480,000(L/d)^2 \leq 1600$ psi, where,

L = unbraced length of member

D = lesser cross-sectional dimension of member

(L and d to have consistent units)

Flexural stress = 1700 psi

³³[See Section 8 Commentary](#)



(reduced to 1500 psi for members with a nominal depth of 8 inches or less)

Horizontal shear = 140 psi

8.4 OTHER MATERIALS

Allowable stresses for materials other than listed in this manual will be reviewed by CTA Engineering on a case-by-case basis. Typically, industry-accepted allowable stresses or load factors (with no overstress allowances) may be acceptable.



(This page intentionally left blank.)



SECTION 9 SPECIAL CONDITIONS

9.1 SEALED SHORING

Under certain conditions, excavation below the groundwater table will require that a sealed shoring system be utilized. Examples of situations where sealed shoring is needed include, but are not limited to:

- Excavations in permeable soils where dewatering is infeasible or where the quantity of water to be handled and disposed of would be excessive.
- Locations where the groundwater is contaminated.
- Locations where dewatering would result in unacceptable settlement of the surrounding area.

Relatively watertight shoring is most commonly provided using interlocked sheet piling or diaphragm walls.

Where possible, groundwater flow around the bottom of the shoring wall should be prevented by extending the wall into an underlying low permeability soil layer (such as a clay layer). If a low permeability cut off layer is not present, or if it is at such a great depth that penetrating it is not feasible or cost effective, a tremie concrete or grouted seal slab should be considered for the base of the excavation.

In cases where a positive bottom seal is not provided, the potential for piping must be evaluated. See [Section 9.3](#).

9.2 DEWATERING

Dewatering can be an effective means of reducing shoring loading and improving shoring stability and constructability. In some cases, it may also be required to allow construction of proposed project elements.

In cases where dewatering is not precluded by other factors (see [Section 9.1](#)), CTA will consider allowing dewatering, provided that it won't cause problematic settlement to tracks or other infrastructures. Pumps of sufficient capacity shall be provided and maintained at the site, and continually attended on a twenty-four (24)-hour basis, until in the sole judgement of CTA, their operation can be safely halted. The potential for problematic track settlement to occur will be a function of the site soil profile and the depth to which the site needs to be dewatered. Track settlement in excess of that specified in [Section 10.1](#) may be acceptable if it can be shown that differential settlements resulting from dewatering will be minimal (i.e., settlements will occur over a broad area). Engineering calculations demonstrating that excessive differential settlement will not occur will be required.

When dewatering, close observation per accepted monitoring plan shall be maintained to detect any settlement or displacement of transit embankment, tracks, and facilities. Proposed methods of dewatering must be submitted to the CTA for approval prior to implementation. The discharge



from the dewatering operations in the Basic Safety Envelope shall be carefully monitored. The discharge from the dewatering operations in the vicinity of the CTA Zone of Influence shall be carefully monitored. If in the opinion of the CTA, there is an excessive loss of fine soil particles at any time during the dewatering process, the dewatering will be halted immediately. The dewatering operation cannot resume until the unsatisfactory condition is remedied to the satisfaction of the CTA.

In cases where the performance of the temporary shoring system depends upon the functionality of the dewatering system, the dewatering system shall be fail-safe. Elements such as an uninterrupted power supply, back-up pumps, and failure alarm signals will be required to guarantee that the dewatering system will never shut down for a period of time that could compromise the stability of the shored excavation.

Dewatering system design shall be performed by a Professional Engineer registered in the State of Illinois with previous experience in the design of the specific type of dewatering system being proposed. Removed water shall not be drained along the tracks, but shall be drained off the Right-of-Way in accordance with environmental restrictions. Unless otherwise specified by the Professional Engineer, dewatering shall be limited to a total of approximately 900 gallons.

9.3 BOTTOM STABILITY

9.3.1 Piping

For excavations in pervious materials, the possibility of piping must be evaluated. Piping occurs when an unbalanced hydrostatic head causes large upward seepage pressures in the soil at and below the bottom of the excavation. The upward seepage pressure reduces the effective weight of the soil below the bottom of the excavation. As a result, the ability of the soil to laterally support the embedded portion of the shoring wall (i.e., passive resistance) is reduced. In the extreme, a quick condition can develop at the bottom of the excavation and large quantities of soil can be transported rapidly from outside to inside the excavation, thereby causing large ground settlements, and possibly even shoring system collapse.

Piping can be controlled by dewatering outside the shoring walls (where allowed) or by making the shoring walls deeper in order to reduce the upward hydraulic gradient. Alternatively, a tremie or grouted slab can be used as a bottom seal.

The potential for piping may be evaluated using published procedures³⁴. The minimum acceptable factor of safety against piping shall be 1.5. Additionally, a reduction in the available passive resistance due to upward seepage pressures shall be taken as appropriate.

³⁴[See Section 9 Commentary](#)



9.3.2 Bottom Heave

In cases where excavations are made in soft (and sometimes medium) clays the potential for bottom heave must be evaluated. Bottom heave occurs when the depth of excavation is sufficient to cause upward movement of material in the bottom of the excavation and corresponding downward displacement of material surrounding the excavation. Heave can result in excessive settlement of the ground retained by the shoring system, and distress or failure of the shoring.

The possibility for heave should be evaluated further in cases when the Stability Number (N_o) exceeds 4, where:

$$N_o = (\gamma H + q)/c, \text{ and}$$

γ = unit weight of soil
 H = depth of excavation
 q = vertical surcharge pressure
 c = cohesive strength of soil

When N_o exceeds 4, the factor of safety against bottom heave should be computed using procedures outlined in the Caltrans “*Trenching and Shoring Manual*”. The minimum acceptable factor of safety against bottom heave shall be 1.5. A factor of safety of 2 and greater is preferred since bottom heave also contributes to the lateral wall movement. Refer to [Section 7.9](#) for lateral wall movement for excavations in soft to medium clays.

9.4 GLOBAL STABILITY

Typical shoring applications may not require global slope stability analysis. The Engineer in Responsible Charge shall determine if global stability calculations are warranted. However, CTA Engineering reserves the right to require global stability calculations at their sole discretion. As an example, when ERS is proposed outside the Zone of Influence in Figure 3 - 1 with existing building demolished, global stability can be affected when the soil is soft or medium clay.³⁵

If applicable and/or required by CTA, temporary shoring systems and sloped excavations shall be demonstrated to be safe using limit equilibrium analyses with appropriate potential failure surfaces (A potential failure mode is mentioned in [Section 5.6](#)). Slope stability analyses shall consider the presence of rapid transit live loading, applicable railroad live loading such as Cooper’s E-80 on active tracks, and/or construction equipment.

The minimum factor of safety against failure of the whole, or any portion of, shored or sloped cuts shall be 1.5.

9.5 TIEBACKS

Per [Section 4.3](#), shoring wall with tiebacks is a prohibited shoring type, unless otherwise approved by CTA. The approval of utilizing tiebacks will be reviewed by CTA Engineering on a

³⁵[See Section 9 Commentary](#)





case-by-case basis at their sole discretion. If tiebacks are permitted they must be installed using a method in which the drilled holes for the tiebacks will be stable and open at all times. In some soil types, this will necessitate fully cased holes beneath active tracks. Tiebacks shall be located a minimum of five (5) feet below top of rail.

Tiebacks shall be designed in accordance with the procedures and criteria outlined in the Post-Tensioning Institute (PTI), Recommendations for Prestressed Rock and Soil Anchors, with the exception that the allowable stresses for the tieback tendons shall be limited to those values specified in [Section 8.1](#) of this Manual. A minimum factor of safety of 2.0 shall be used.

All tiebacks shall be load tested. The tieback load testing procedure, schedule, and acceptance criteria shall be developed by the qualified Engineer in Responsible Charge. At a minimum procedures and acceptance criteria for performance and proof testing shall conform to the following, unless otherwise directed by the qualified Engineer in Responsible Charge. The Engineer in Responsible Charge shall witness one proof test and one performance test. The first three (3) tiebacks installed and a minimum of 10% of the remaining tiebacks shall be performance tested. All remaining tiebacks shall be proof tested.

- Proof test shall be made by incrementally loading consist of Alignment Load, 20%, 50%, 75%, 100%, 120%, and 133% of Design Load. Lock off at 100% Design Load.
- Performance test shall be made by incrementally loading per the proof test load schedule shown above, but unload to Alignment Load at every proof test level. Lock off at 100% Design Load.
- The maximum test load in the proof and performance test shall be held for 10 minutes. The tieback movement with respect to a fixed reference shall be measured and recorded at 1 minute, 2, 3, 4, 5, 6, and 10 minutes. If tieback movement between 1 minute and 10 minutes exceeds 0.04 inches, the maximum test load shall be held for an additional 50 minutes, 20, 25, 30, 45, and 60 minutes. The total movement if the load hold is extended, shall not exceed 0.08 inches. The load hold time shall begin when the pump starts to raise the load from the 120% Design Load increment to the 133% Design Load increment.
- The minimum apparent free length at the test load, as calculated on the basis of elastic movement, shall be equivalent to not less than 80% of the designed free tieback length plus the jack length.
- If tieback is unacceptable after the test, the Contractor has the option to post-grout the tieback, up to two additional times, or until 300 psi is observed at the grout pump, and perform the test again. If tieback is again unacceptable, notify the qualified Engineer in Responsible Charge.

When tiebacks are bonded in fine-grained soils, creep testing shall be done in lieu of performance testing. Creep testing procedures and acceptance criteria shall conform to those given for temporary anchors in the Post-Tensioning Institute (PTI), Recommendations for Prestressed Rock and Soil Anchors.



In addition to the PTI Recommendations for Prestressed Rock and Soil Anchors, the designer may also reference FHWA Geotechnical Engineering Circular No. 4, Ground Anchors and Anchored Systems, FHWA-IF-99-015.

9.6 DEADMEN

Under the appropriate conditions (where any other alternate is not practical) CTA may allow temporary shoring walls to be supported using deadmen located on the opposite side of the tracks from the shored excavation. The proposed location(s) for deadman anchorage will require review and acceptance by CTA and any Third-Party property owners as appropriate.

Deadman anchorage may be provided by soldier piles, sheet piling, or concrete blocks or walls. Deadman anchors shall be designed to provide a minimum factor of safety of 2.0 against failure.

In order to minimize the deflection of the shoring, deadman anchors shall be prestressed to remove the slack in the system and to mobilize the passive resistance. A portion of the final design load shall be locked off.

Tie rods that pass under the tracks must be electrically isolated from the track. Details of proposed system of electrical isolation shall be submitted for review.

9.7 MICROPILES

If warranted by low headroom clearance, Micropiles with Lagging type of shoring wall may be permitted.

Wall thickness reduction in design shall be in accordance with [Section 8.1.1](#). Threaded joint design/detail shall be in accordance with [Section 4 Commentary](#)⁷. When threaded joint cannot provide the required bending capacity, it is acceptable to provide an inner casing extending beyond each side of the threaded joint as reinforcement. The inner casing can either be designed to fully resist the bending demand, or resist the bending demand minus the bending capacity threaded joint can provide.



(This page intentionally left blank.)



SECTION 10 TRACK, STRUCTURE, AND SHORING MONITORING

10.1 PURPOSE

CTA requires monitoring of the excavation, temporary shoring system and adjacent track(s) and structures throughout the duration of shoring installation, excavation, construction, removal and backfill. The monitoring procedures specified below are intended to confirm that shoring systems are performing in a satisfactory manner and to identify locations of excessive ground movement so that they can be controlled and corrected in a timely manner with the pre-approved contingency plans. The frequency of monitoring is previously mentioned in [Section 3.1 Zone of Influence](#) and will be further discussed in this Section.

The Contractor's field instrumentation specialist shall be responsible for purchasing, installing, and obtaining data for the ground instrumentation and the structural instrumentation. The field instrumentation specialist shall be a registered Professional Engineer in the State of Illinois and have demonstrated previous successful experience on a minimum of two (2) projects in installation and monitoring of the types of instrumentation specified herein. The field instrumentation specialist shall have supervised instrumentation programs similar in magnitude and similar in subsurface conditions on at least one (1) project. The instrumentation specialist shall be on-site and supervise at least the first five (5) installations of each type of instrument; supervise and establish the formal initial reading for each instrument installed; and, supervise the interpretation of all instrumentation data. The Contractor shall be responsible for providing access to instrument locations throughout construction.

10.2 LIMITATION ON TRACK MOVEMENT

CTA requires that track settlement or track heave associated with all aspects of shoring and excavation shall not exceed the Limiting Value vertical change. Track movement shall not exceed Limiting Value horizontal change due to temporary shoring and excavation. Track resurfacing (i.e. track tamping) or other remedial measures will be required if these limits are exceeded. In addition to Limit Values, minimum Warning Values are also implemented and required by CTA to ensure a sufficient time window can be provided to implement contingency plans as specified for stopping further movement.

- Responses required when the change in vertical and horizontal location of the running rail exceeds the: **Limiting Value of 1/4 inches.**
 - Suspend all construction activities in the affected area and notify CTA immediately.
 - Within 24 hours of reducing instrumentation data indicating that a Limiting Value has been reached, implement contingency plans per the Contractor's CPP for stopping further movement.
 - Perform a detailed evaluation of construction procedures and submit to CTA the evaluation and recommended procedures to reduce movement. Furnish and



install additional instruments if they are needed to further define the magnitude of the indicated problem. Obtain approval of the Authority prior to restarting work.

- Responses required when the change in vertical and horizontal location of the running rail exceeds the: **Warning Value of 3/16 inches.**
 - Notify CTA immediately. CTA Engineering may require the Contractor to suspend activities in the affected area with the exception of those actions necessary to avoid reaching the Limiting Value.
 - Increase frequency of monitoring readings. See [Section 10.3](#).
 - Supplemental readings will be required. See [Section 10.4](#).

10.3 MINIMUM MONITORING REQUIREMENTS

The excavation and temporary shoring system shall be visually inspected at least daily by a qualified field instrumentation specialist or the appointed qualified personnel to check for obvious movements or changes that were unplanned or that may be detrimental to transit operations or safety. Visual monitoring should be performed more often during the performance of critical activities, such as excavation or foundation installation immediately adjacent to shoring or after moderate to severe rain events.

CTA requires that tracks adjacent to excavations and above Jack-and-Bore/ Horizontal Directional Drilling Construction within the Zone of Influence be monitored for movement and settlement. At a minimum, track monitoring shall consist of the following:

- Survey points shall be established along all tracks for which the excavation is within the Zone of Influence. It is recommended to establish the survey points on the crossties adjacent to the running rails.³⁶ The maximum spacing and minimum extent of these points shall be as shown on **Figure 10 - 1**. A minimum of three (3) control points shall be established in areas that will not be subject to possible disturbance due to construction activities or railroad operations. CTA recommends that baseline readings be done over three (3) days and the average of readings be used as the baseline.
- The horizontal coordinates and elevation of both rails shall be measured at each survey point location in accordance with the following schedule and frequency:
 - a. Prior to starting any work associated with installation of the shoring system, a baseline reading of horizontal coordinates, elevations, temperature, and dynamic rail movement (see [Section 10.4](#)) shall be taken at each survey point identified. In cases where track maintenance activities are performed to correct movements, a new baseline shall be established and its relationship to the

³⁶[See Section 10 Commentary](#)



previous baseline documented. CTA recommends that baseline readings be done over three (3) days and the average of all readings be used as baseline.³⁷

- b. From the time at which shoring installation commences until excavation reaches the design elevation and the shoring system is in its final design condition, readings at each survey point of the horizontal coordinates and elevations shall be taken on a daily basis before and after each work shift for all Zones shown in **Figure 3 - 1**. Supplemental readings will be required if excessive or unanticipated settlements are recorded more than the Warning Value.
- c. For seven (7) consecutive days after excavation reaches to the design elevation and the shoring system is in its final design condition., a minimum frequency of one reading of horizontal and vertical coordinates per day shall be performed for each monitoring point.
- d. After seven (7) days of one (1) reading of horizontal and vertical coordinates per day, bi-daily readings shall be performed for each monitoring point or instrumentation during the construction but prior to shoring removal.
- e. Monitoring frequency will return to once daily basis if conditions warrant. Conditions include: modifications are made to shoring structures that change the load path or stiffness, weather condition changes such as heavy rain, freezing temperature and thawing temperature, readings that hit the warning limits and others as directed at the sole discretion of CTA.
- f. If permitted, from the time at which shoring removal commences until excavation is backfilled to the grade elevation, readings shall be taken on a daily basis for all Zones shown in **Figure 3 - 1**.
- g. After shoring removal has been completed and excavation has been backfilled, readings shall continue on a once weekly basis for a minimum of four weeks.
- h. Other monitoring instruments, such as inclinometers, and reading frequency of these instruments, may be requested by CTA, or recommended by instrumentation specialist based on cases by case basis. See [Section 10.5](#).
- i. For Jack-and-Bore Construction, follow above requirement (a) to set up baseline reading prior to starting any work. The Contractor shall monitor the track and ground/ballast movement immediately after the Jack-and-Bore operation comes to a stopping point such as splicing a new casing, obstruction encountered, or breaks, etc.
- j. For Horizontal Direction Drilling Construction, follow above requirement (a) to set up baseline reading prior to starting any work. The Contractor shall monitor the

³⁷[See Section 10 Commentary](#)



track and ground/ballast movement immediately after drilling, reaming, and pullback operations.

Raw survey data shall be made available to CTA within one working day of the readings are made. The field instrumentation specialist will reduce and interpret the data and make the reduced data and interpretations available to the Contractor and CTA as soon as practicable, but no more than one (1) week after the readings are taken, and shall be provided on a form similar to that shown in [Appendix E](#).

Neither CTA nor their representatives are in any way responsible for the safety and serviceability of the work. The Contractor shall not disclose instrumentation data to third parties, and shall not publish data without prior approval of the CTA.

Monitoring of the shoring structure is required since movement in the structure may precede and predict potential movement in the track.

Monitoring of the open-cut excavation is required since movement in the excavation may precede and predict potential movement in the track.

10.4 SUPPLEMENTAL MONITORING

Supplemental monitoring will be required when Warning Value is reached, and may be required by CTA in the case of movement less than the Warning Value as CTA deems necessary. Supplemental monitoring consists of the following:

- Measurement of rail movements under load using a dynamic voidmeter. Measurements shall be taken at the same locations as the survey points that reached Warning Value for both running rails.
- More frequent survey measurements of static top of running rail elevations and coordinates, and dynamic running rail movements and cross-slope. Monitoring frequency must be increased to twice per day (before and after a day shift) until corrections have been executed and CTA infrastructure is deemed stable.
- Provide CTA static and dynamic survey data, in a form similar to [Appendix E](#), immediately following the survey.
- More frequent monitoring measurements of shoring structure.

The following Supplemental Monitoring and Actions are required for Micropile installation is within the CTA's Zone of Influence:

- Once the 3/16" Warning Value is reached, stop drilling and continuously monitor settlement until no further settlement is detected for at least ten (10) minutes. Wait for CTA representatives to arrive on site and confer prior to restart of drilling, and if no further settlement is detected, perform continuous settlement monitoring until micropile casing has reached competent soil layer such as hard clay.
- If settlement reaches the 1/4" Limiting Value, stop drilling and have flaggers hold trains on the nearest track. Continuously monitor for additional settlement. If no further



settlement occurs within thirty (30) minutes, request flaggers to release trains under six (6) mph speed restriction. Begin to install shoring and stabilizing micropile hole such as grouting.

- If additional settlement occurs beyond the 1/4" Limiting Value, halt all further train movements on nearest track. Begin to make provisions for emergency single track and installation of shoring. Contact the temporary shoring Engineer in Responsible Charge and request assessment of stability of the settled track structure. In parallel, contact CTA representatives to inspect the trackwork for deformation and/or discontinuity. Restore train service on nearest track if there is consensus between CTA representative and temporary shoring Engineer in Responsible Charge that track and structure is stable. Impose the six (6) mph speed restriction until such time the temporary shoring is fully engage.
- If the final settlement is equal or greater than 3/8", correction measures shall be taken to bring the track structure/rail elevation back to the baseline measurements. Refer to [Section 11.3.2](#) for additional requirements.

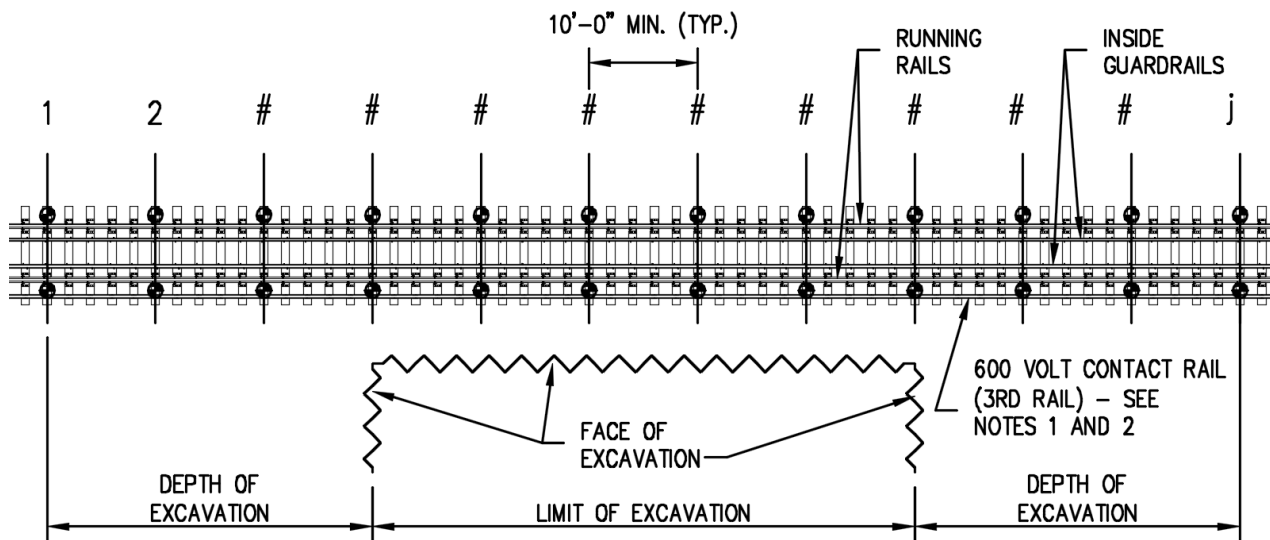

⊕ MONITORING POINT – TWO PER TIE (ONE FOR EACH RUNNING RAIL)

NOTES:

1. THE CONTRACTOR SHALL USE EXTREME CAUTION WHEN WORKING NEAR THE 600 VOLT CONTACT RAIL. ADEQUATE PERSONAL PROTECTIVE EQUIPMENT AND INSULATING 3RD RAIL COVERS MUST BE UTILIZED AT ALL TIMES.
2. LOCATION OF 3RD RAILS ALONG TRACKS WILL VARY – STATION AREAS VS NON-STATION AREAS.

Figure 10 - 1: Minimum Monitoring Requirements



10.5 SPECIAL MONITORING

CTA reserves the right to require that special monitoring be done for large, atypical, or long-lived shoring projects. Special monitoring may include the use of inclinometers, piezometers, tiltmeters, or other types of monitoring instrumentation. CTA will address this issue on a project-specific basis.

If open-cut adjacent to CTA tracks or track structures are permitted by CTA with Variance Request Form, inclinometers will be required to monitor the slope stability.

10.6 ACCESS AND FLAGGING

Access and flagging for establishing and reading survey points and monitoring instrumentation shall be coordinated with CTA Construction, Safety and Rail Operations.



SECTION 11 OTHER TYPES OF ADJACENT CONSTRUCTION

All sections of this Manual shall apply to this Section 11, where applicable, unless specifically modified within this Section.

11.1 CONSTRUCTION ADJACENT TO CTA UNDERGROUND STRUCTURES

11.1.1 General

The structural response and safety of underground Structures affected by Adjacent Construction activities has been a primary concern and CTA has attempted to establish criteria to restrict ground movements to be induced. However, most criteria adopted by other agencies are mostly arbitrary because of the lack of research and case study, and the complicated nature of this topic. Currently this concern is primarily addressed by monitoring movement and vibration with equipment such as inclinometer, tiltmeter, crack monitor, and survey. Therefore, Special Monitoring required in [Section 10.5](#) will be requested when the Adjacent Construction is adjacent to or over existing CTA underground structures and/or structures and will be handled on a case-by-case basis depending on the existing condition of the underground structures after initial inspection, existing soil condition, excavation size, tunnel alignment in relation to the excavation (direction of ground movement), etc. **Figure 11 - 1** demonstrates an example on how the damage potential would depend on tunnel alignment in relation to the excavation (direction of ground movement).

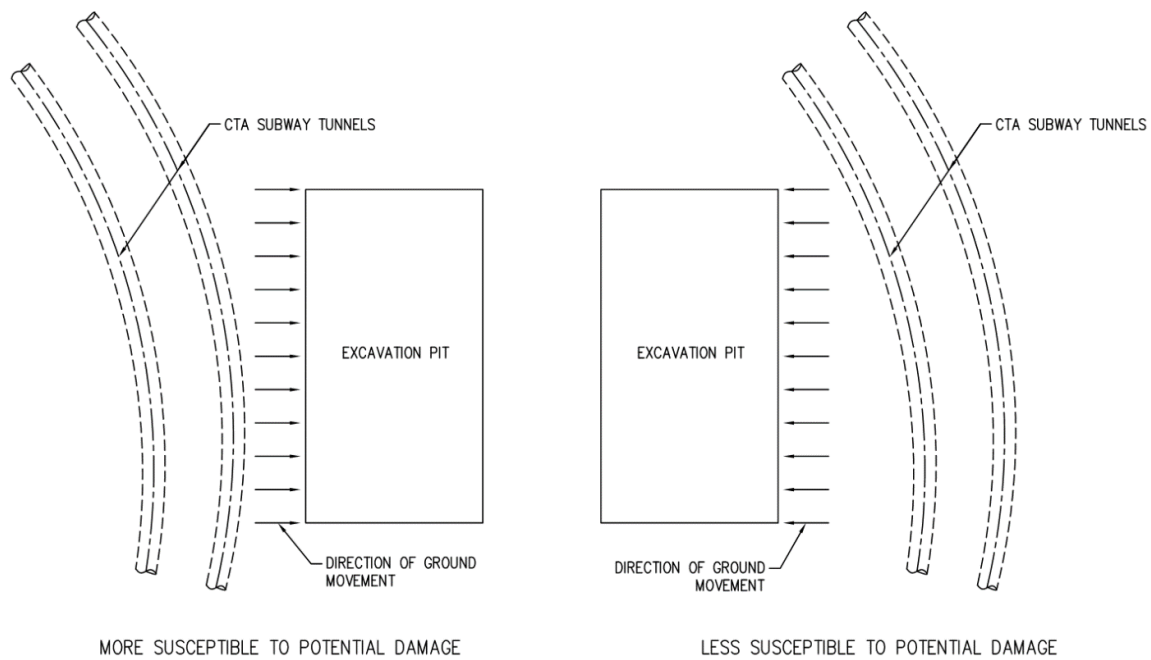

Figure 11 - 1: Tunnel Alignment in Relation to the Excavation



11.1.2 CTA Underground Structure Zone of Influence

In general, CTA requires all CTA underground structures including underground structures, subway station structures, and vent shafts to be fully re-evaluated for the effects caused by the Adjacent Construction, except for the cases shown later in this Section. The Zone of Influence diagram for CTA underground structures is shown in **Figure 11 - 2**. Refer to [SECTION 4](#) through [SECTION 9](#) for ERS design requirements.

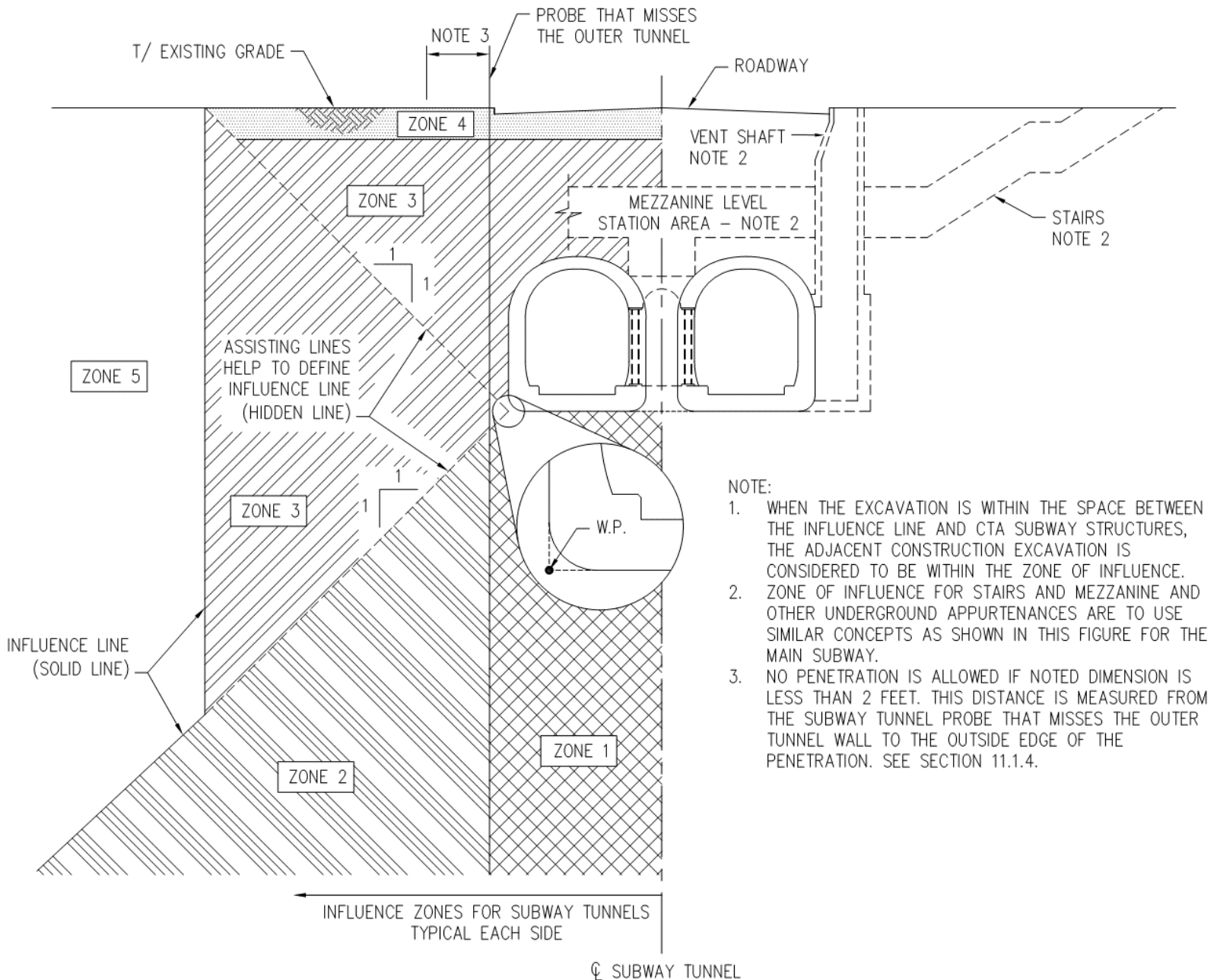

Figure 11 - 2: CTA Underground Structure Zone of Influence



Zone 1:

- **Excavation is prohibited.**



Zone 2:

- **No excavation or temporary shoring installation will be allowed without the special written permission of CTA.** Requirements for requesting a variance are provided in [Section 2.2](#).
 - If CTA grants a variance to allow excavation, a rigid/stiff support of excavation system with slurry walls, tangent piles, or secant piles shall be used. For design, the at rest earth pressure shall be used on the retained soil side. All brace levels shall be preloaded to control ground movements.
 - CTA tunnel structures shall be analyzed with the consideration of soil unloading.
 - Shoring installation shall be completed prior to any excavation.
 - Any other flexible ERS system, if a prior approval of CTA is obtained, may have to be designed for a higher stiffness factor and requirements, based on a case by case basis. When the ground conditions warrant, use of ground stabilization with flexible support of excavation, in lieu of rigid support of excavation may be approved by CTA at its sole discretion. If fixable support of excavation is used, underpinning of the CTA underground structures/structures may be required.
 - If underpinning is requested, the underpinning structure must receive the support at least five (5) feet below the Line of Influence shown in **Figure 11 - 2**.



Zone 3:

- All requirements in Zone 2 shall apply with the exception that flexible ERS system is permitted without a Variance Request.



Zone 4:

- Minor excavation over CTA underground structures for underground utility work may not require the complete tunnel analysis outlined in [Section 11.1.3](#) depending on the size of the excavation. Generally, the excavation is considered minor if depth of excavation is less than 5 feet, length of excavation is less than twenty-five (25) feet, and width of excavation is less than twenty-five (25) feet. However, structure movement monitoring may be required by CTA based on a case by case basis, at the sole discretion of CTA.



Zone 5:

- Excavation may be shored or slope cut and no impact to CTA underground structures.



CTA subway mezzanine level and vent shaft structures are usually structurally supported by the subway tubes and do not require bearing on soil for vertical support. When excavations in Zone 3 expose the mezzanine level and vent shaft structures, coordinate with CTA for additional requirements for temporary support for the mezzanine structures.

CTA subway station auxiliary stairs usually do not have footings and soil bearing is required for vertical support. When excavations in Zone 3 expose the stairs, shoring will be required.

11.1.3 Tunnel Analysis Criteria

All existing underground structures shall be considered to be already under the long-term loads. Any changes in the loading (additional loads and/or soil unloading), due to adjacent excavation and construction, on the tunnel should be applied to these existing long-term loads for analysis. The users of this Manual can assume all CTA underground structures are cut and cover.³⁸

- For CTA cut and cover structures:
 - If new construction is adjacent to or over existing CTA cut and cover structures, establish the short term and long-term loading conditions that will result from the adjacent construction and compare with the existing CTA cut and cover structure loading condition.
 - If any of the short term or long-term pressures due to the adjacent excavation and construction fall outside of the original range/limits of the design pressure, for which the existing CTA structure was designed, a structural analysis shall be conducted on the CTA structure to determine its adequacy to withstand the anticipated earth pressures and construction loads without overstress or cracking. The analysis shall be submitted for CTA review.
- The structural check of existing CTA cut and cover structures must include calculations for the following:
 - Stresses in the tunnel structure/liner.
 - Tunnel section distortion.
 - Lateral shift of tunnel.
 - Opening of the joints and possibility of water leakage at bolted joints. Bolt stresses shall be calculated.
- A computer analysis shall be performed to determine the effect of the new construction will have on the tunnel support system (liner). The tunnel liners may be modeled as straight members continuously joined together. For circular liners, the joints shall be taken at no more than ten (10)-degree angle subtended at the center. Radial soil-spring supports, at all joints are recommended to achieve a proper loading regime. Spring

³⁸[See Section 11 Commentary](#)



properties should correctly simulate the soil or rock modulus correlated with the soil data and soil properties given in the site specific geotechnical report.

- In lieu of a more complete analysis, the following procedure may be used to determine the effects on CTA tunnel liners. Joint loads should be determined by first assuming a one-foot length of tunnel liner and then calculating the tributary area at each joint. The resultant value should then be multiplied by the corresponding ordinate of the pressure diagram to arrive at the joint load. Radial, compression springs representing the modulus of subgrade reaction should be considered at each joint. Member properties and spring properties should be calculated per foot length of the liner, for the computer input data.
- When the computer model is run, the springs should be released to eliminate spring-tensions until springs are only acting in compression. The plot of the deflected liner should be compared with the assumed spring-releases, and trial runs should be made until the deflected shape corresponds with the spring-releases. Alternatively, a computer program that automatically eliminates the tension spring until convergence is achieved could be used. Selective checks using hand calculations should be performed to establish the accuracy of the computer analysis.

11.1.4 Drilled, Augered, Driven and Vibrated Penetration Construction Protocol

This section applies to penetrations **adjacent to and within twenty (20) feet but no less than two (2) feet to underground CTA Structures** including installation of slurry walls, tangent piles, secant piles, and drilled shafts/caissons, including probing operation, or any other type of substructures that require penetrating the soil, such as Geopiers, etc. Distances are measured from the underground structures probe that misses the outer tunnel wall to the outside edge of the penetration (not the final penetration size) at the underground structures elevation. The maximum out of plumb and layout for the center point must be considered.

A pre-inspection, a post inspection, and a Damage Letter are required for all depths.

The following requirements shall apply unless otherwise approved by CTA through the variance request outlined in [Section 2.2](#) at the sole discretion of CTA:

- General

The project's structural drawings shall show the underground structures in plan and cross section.

The underground structures shall be located from the north/south and east/west coordinates of the right-of-way lines and from adjacent penetrations.



To verify the actual location, depth, and profile of the underground structures, probing may be required on a case-by-case basis based on location³⁹ when any proposed penetration is within a minimum horizontal distance of twenty (20) feet at curved section of tunnel and ten (10) feet at straight section of tunnel as measured from the outside edge of the theoretical tunnel wall or within a vertical distance of ten (10) feet as measured from the theoretical outside top of the underground structure to the bottom of the penetration. (Probing may be required to determine the appropriate course of action to allow a penetration to proceed above, adjacent to, and beyond the underground structures.)

If probing cannot be performed due to the availability of the site or interference from existing structures, or utilities, the underground structures shall be surveyed from within the interior of the underground structures. The thickness of the underground structures walls shall be considered twenty-four (24) inches, or as otherwise shown in as-built drawings. A precautionary twenty-four (24) inches wide safety zone shall be added to adjust for the outer limit of the tunnel wall(s).

For determining the placement of a penetration (after probing is complete) adjacent to the underground structures, the outer limits of the underground structures shall be considered to be the probe that does not touch the outside wall of the underground structures and exceeds the depth of the underside of the underground structures floor by a minimum of ten (10) feet.

Prior to proceeding with any penetration above, including probing, adjacent to, and beyond the underground structures, a Structural or Professional Engineer licensed in State of Illinois shall inspect and document both by photograph(s) and videotape the existing conditions and structural integrity of the underground structures. The owner of the property or its representative at its sole cost shall employ the services of a licensed State of Illinois Engineering Firm. All inspections shall be done in the presence of CTA. The right of way lines and excavation locations shall be clearly identified at grade level by use of monuments and marked as approved by CTA. Within thirty (30) days after the completion of all penetrations the licensed State of Illinois Structural or Professional Engineer shall schedule a final tunnel inspection with CTA. A final inspection report signed and stamped by the licensed State of Illinois Structural or Professional Engineer shall be submitted within thirty (30) days after the final inspection. Based on the type, depth, and location of the penetration; CTA will determine the distance from the underground structures to the penetration that will require a pre and post inspection. The minimum required distances are twenty (20) feet.

The Contractor or Subcontractor shall provide a CPP including the procedures, means, and methods for performing the underground structures probes and/or penetrations above, adjacent to, and beyond the underground structures. Soil boring reports are to

³⁹[See Section 11 Commentary](#)



accompany all requests for underground structures probing and/or penetrations above, adjacent to, or beyond the underground structures. Elevations and soil profiles shall be referenced by depth and the City of Chicago Datum (CCD). The procedures shall be submitted prior to CTA issuing its authorization to the OUC. The maximum allowable out of plumb and layout for the center point for penetrations shall be noted on the procedures. Procedures for monitoring plumb and layout for the center point shall be included. Procedures are to include a repair procedure if the underground structures are penetrated or damaged during probing.

To prevent damage to the existing underground structures drilling shall cease immediately if an obstruction is encountered within five (5) feet of the underground structure.

If the underground structure is penetrated or damaged during probing, or by any other penetration, all operations are to cease and CTA is to be notified immediately. The Contractor shall not remove the casing, drill bit, auger, rods or etc. from the borehole or shaft. A repair procedure approved by CTA shall be implemented. Upon completion of the repair work a licensed State of Illinois Structural Engineer shall inspect and approve the repairs to the interior of the tunnel liner and provide photographs and documentation of the final repairs to CTA.

The Contractor shall notify CTA that they will resume the approved construction activity above, adjacent to, and beyond the underground structures.

Field personnel performing the penetrations shall be fully knowledgeable of the elevations and locations of the underground structures.

- Underground structures Probing

Probing operations shall commence with the drilling of a temporary casing to a suitable clay layer, at various CCD elevations, as determined by the soil borings.

A minimum of four (4) probes will be required to determine the location, depth, and profile of the underground structures. A minimum of two (2) groups of probes are required for each straight section of tunnel. A minimum of three (3) groups of probes are required for each curved section of tunnel. The first probe to be drilled shall be the furthest from the underground structures; the remaining probes shall be advanced toward the underground structures.

The probe hole to the underground structures will be drilled to within a caution distance of approximately fifteen (15) inches of the calculated probing length. Drilling operations shall stop at the calculated caution distance to prepare for possible contact with the underground structures or for sound level monitoring from within the underground structures. The approximate drill bit location shall be estimated from sound monitoring



within the underground structures. The underground structures shall not be penetrated during probing procedures. Upon encountering the underground structures, the location of the probe, the angle of the probe (if any), and the depth of the probe from existing grade to the underground structures shall be recorded.

During withdrawal of the drill bit and extension rods, the entire cavity, annular space, and voids caused by the displaced soil shall be completely filled with a bentonite-cement grout.

If the underground structure is penetrated or damaged during probing all operations are to cease and CTA is to be notified immediately. The Contractor shall not remove the casing, drill bit, auger, or rods from the borehole.

Within fifteen (15) days after the completion of the underground structures probing the owner or his representative shall provide CTA with a detailed drawing prepared and stamped by a licensed State of Illinois Structural or Professional Engineer indicating the location of the probes. The detail drawing at a minimum shall include the locations from the north/south and east/west coordinates of the right-of-way lines; the depth of penetration; the distance between probes; and the outside limits of the underground structures walls.

- Special Inspection and Monitoring

When drilling operations occur within ten (10) feet of straight portion and twenty (20) feet of curved portion of underground structures, CTA will assign, on a full-time basis, a minimum of one inspector in the underground structures, along with required number of flaggers, and one inspector at surface level with the drilling operator. In cases where there are multiple tunnels affected by operations additional inspectors will be assigned as needed. Inspections shall begin prior to any construction activities proceeding adjacent to the underground structures to obtain a baseline condition of the tunnel.

- Calculation Submittals

Calculations by a licensed State of Illinois Structural or Professional Engineer shall be provided to CTA demonstrating the hydrostatic pressure from the wet concrete, slurry, or from driven piles will not induce additional stresses and cause failure to the underground structures. The allowable stresses on the underground structures shall be in accordance with current American Concrete Institute Building Code Requirements. If the stresses will affect the structural integrity of the underground structures a permanent steel casing is required. The preliminary compressive strength of the concrete of the underground structure shall be assumed to be 2000 psi. In lieu of this calculation submittal the contractor can chose to provide permanent casing as described below for caissons/drill shafts.



- Special Requirements for Caissons/Drilled Shafts

A permanent steel casing is required from five (5) feet above the top of the underground structure to five (5) feet below the underside of the underground structure floor, however, the soil profile may require that the permanent steel casing be placed above and below these limits. For example, when soil profiles show soft to medium clay with unconfined compressive strength not able to satisfy the following equation:

$$Q_u \text{ required (tsf)} \leq H \text{ (ft)} / 50, \text{ where H is the depth of excavation}$$

Removal of soil within the casing shall not be advanced beyond the limits of the permanent casing, two (2) feet of unexcavated soil shall be maintained at all times in the casing.

At CTA's discretion, based on soil and underground structures conditions:

- The excavation may be performed under a slurry head. Excavate to five (5) feet above the top of the underground structures; fill the excavation with a slurry to the existing grade; excavate to five (5) feet below the underside of the underground structures floor and insert the permanent casing.
- The excavation may proceed to five (5) feet below the underside of the underground structures floor without the permanent casing being in place. After obtaining the required depth, grout shall be poured from the bottom of the excavation to five (5) feet above the top of the underground structures. The permanent casing shall be inserted in the wet grout to the bottom of the excavation. Once the grout has obtained its initial set, excavation may proceed through the grout and the remaining soil.

CPP Requirements for Caissons: For all caissons within the 10 ft/20 ft rule, provide cross section of caisson with soil profile, relative top, bottom, and side distances to CTA structure, casing information, and each step in the drilling process.

Once the excavation has started for an adjacent caisson/drilled shaft beyond the bottom of the casing, the work of that caisson shall be carried on continuously, twenty-four (24) hours a day, including Saturday, Sundays, and Holidays, until the caisson has been completed. If any time, work on any adjacent caisson is not continuous for any reason, it shall be backgrouted immediately.

When there is a line of caissons/drilled shafts longitudinally adjacent to the CTA underground structures and/or structures, including secant walls, shaft installation shall be one at a time. Under no circumstances shall there be more than one shaft open.

- Special Requirements for Micropiles



Flaggers are always required for micropile installation. **When micropile installation is adjacent to CTA substructures within the zone of influence, the installation method shall be Rotary Duplex Drilling method.** Drill bit shall not extend beyond the casing in weak soil layers such as sand, very soft to soft clay, etc. Especially when it is within the Zone of Influence. Soil boring logs shall be submitted with the micropile installation process plan for reference.

The drilling operation shall avoid external flushing as practicable as possible. Measures may include but not limited to:

- Provide continuously monitoring of the flushing fluid/air pressure.
- Limiting the maximum distance that drill bit can extend beyond the casing in competent soil.

Special Supplemental Monitoring is required for Micropile installation. Refer to [Section 10.4](#) for additional monitoring requirements.

11.1.5 Heavy Vehicles/Equipment Above CTA Underground Structures and Structures

Any heavy vehicles or equipment with axle loads greater than axle loads for the AASHTO design truck (HS20-44 or HL-93), that would impose loads on CTA underground structures and/or structures, shall require structural analysis to verify CTA structures will not be impacted. For stationed equipment with outriggers, crane mat shall be provided at outriggers to ensure the distributed maximum outrigger force will not exceed 240 psf on the street level. Submit signed and sealed IL Structural Engineer drawings and calculations to CTA for review.

11.2 CONSTRUCTION ABOVE AND ADJACENT TO CTA TRACK AND FACILITIES

11.2.1 General

Structures shall be designed per the requirements of the local jurisdictional codes. Structures MUST satisfy the CTA train clearance envelope as shown in [Appendix B](#). Bridge structures over CTA tracks and facilities shall incorporate protective measures to guard against objects or debris from entering CTA Right-of-Way.

11.2.2 Pier/Foundation Wall Protection Adjacent to CTA Tracks

When bridge piers, building foundation walls or other structural elements are within the Basic Safety Envelope and are potentially in the path of a derailed train, they are to be designed per AREMA *Manual for Railway Engineering* Chapter 8 Part 2 Article 2.1.5.1.

Crash walls for piers from twelve (12) to twenty-five (25) feet clear from the center line of track shall have a minimum height of six (6) feet above the top of rail. Piers less than twelve (12) feet clear from the centerline of track shall have a minimum crash wall height of twelve (12) feet above the top of rail.



The crash wall shall be at least 2'-6" thick and at least twelve (12) feet long. When two or more columns compose a pier, the crash wall shall connect the columns and extend at least one (1) foot beyond the outermost columns parallel to the track. The crash wall shall be anchored to the footings and columns, if applicable, with adequate reinforcing steel and shall extend to at least four (4) feet below the lowest surrounding grade.

Alternatively, CTA may consider the use of installing restraining rail to limit lateral movement. Contact CTA for details.

Consideration may be given by CTA, at its sole discretion, to providing protection for bridge piers or building foundation walls over twenty-five (25) feet from the centerline of track as conditions warrant. In making this determination, such factors as horizontal and vertical alignment of the track, embankment height, and an assessment of the consequences of serious damage in the case of a collision will also be considered.

11.2.3 Pier/Foundation Wall Formwork

When bridge piers or building foundation walls are in close proximity to CTA tracks and/or facilities and their formwork failure could potentially damage CTA tracks and structures interrupting CTA normal operations, formwork shall be designed by a structural engineer licensed in Illinois and formwork calculations and shop drawings shall be signed and sealed by the Illinois licensed structural engineer. Formwork shall be designed per ACI 347 – Guide to formwork for Concrete. Actual mix design, actual concrete temperature (or colder temperature to be conservative), and actual pour rate (or faster pour rate to be conservative) needs to be used to calculate the pressure on formwork.

Immediately prior to the Contractor pouring concrete into the forms, the IL SE that provided the design is to visit the site to confirm the installation complies with the drawings and calculations and the mix pour rate and mix design complies. The IL SE must provide verbal confirmation to CTA inspector on site and is to follow with a signed and sealed letter formalizing the verbal confirmation.

In such cases where formwork or accessories are proprietary, [Section 2.6](#) of this Manual shall apply.

11.2.4 Overhead Wire Line Crossings

This section is developed based on Metra Guidelines for Utility Installations and ComEd System Standard and shall apply to overhead electric power lines and non-electrified wire lines over CTA Rapid Transit Right-of-Way. The poles or towers supporting the line shall preferably be outside CTA's Right-of-Way. However, when an overhead wire line crossing over CTA tracks is required, the requirements illustrated in **Figure 11 - 3** apply.

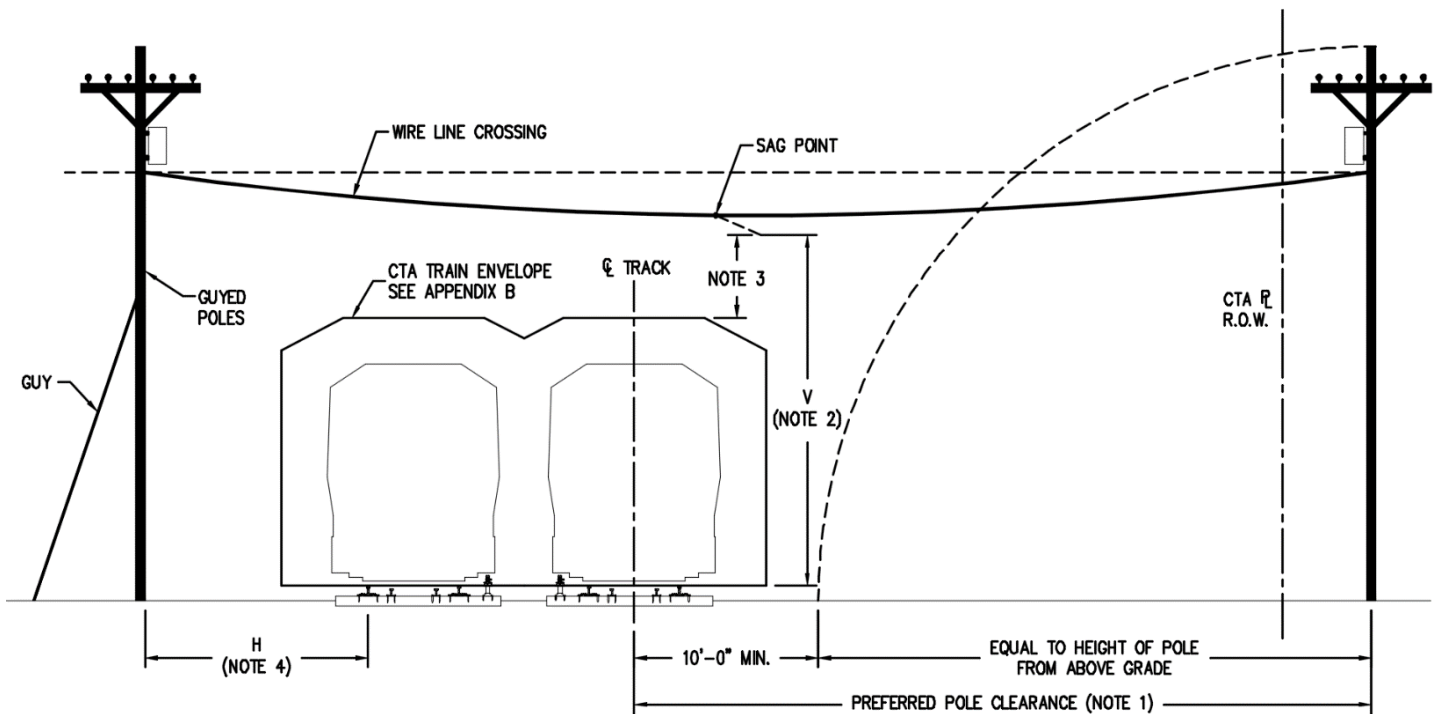

Figure 11 - 3: Overhead Wire Line Crossings Clearance Diagram

1. The CTA preferred pole clearance is shown in **Figure 11 - 3** on the right-hand side and shall always be followed where possible. If not possible, Note 4 denotes the minimum horizontal clearance (H) that must be followed as the minimum clearance for locating poles. Note 2 and 3 denotes the minimum vertical clearance (V and V1) and shall be strictly followed.
2. The minimum vertical clearance (V) shall be as followed:
 - Non-electrified wire lines: 23'-6"
 - Grounded guys, or guys exposed to 0-300V: 23'-6" (note 6)
 - Neutral conductors; terminal bushing; secondary cable; aerial cable: 24'-0"
 - Guys exposed to 300-750V: 24'-6" (note 7)
 - Open supply conductors; spacer cable:
 - a. 0-750V: 24'-6"
 - b. Or guys exposed to 750V-15kV: 26'-6" (note 7)
 - c. Or guys exposed to 15kV-34.5kV: 27'-0" (note 7)
 - d. Above 34.5kV: 27'-0" plus 0.4 inches for each 1,000 volts (note 7)
3. The minimum vertical clearance to the top of the envelope of the train (V1) shall be the minimum vertical clearance (V) minus 14'-6". This dimension is also to be used for any wireline crossings over any CTA structures, such as stations and canopies.



4. Minimum horizontal clearance (H) from the nearest running rail shall be the minimum vertical clearance (V) minus 15'-0" but shall not be less than 12'-0".
5. No additional reduction to H or V is permitted.
6. No clearance from ground is required for anchor guys not crossing tracks or rails.
7. The portions of span guys between guy insulators and the portions of anchor guys above guy insulators that are not grounded shall have clearances based on the highest voltage to which they may be exposed due to a slack conductor or guy.
8. Wooden poles supporting the crossing span shall be side-guyed in both directions (parallel and perpendicular to tracks), if practicable, and be head-guyed away from the crossing span. Braces may be used instead of guys and clearances to guys are to apply to braces. **All down guys shall have high visibility guarding.**
9. Crossing poles and towers shall be located as far as possible from combustible structures. The space around the poles and towers shall be kept free from underbrush, grass, and other combustible material.
10. Where necessary for unobstructed view of wayside signals, signs, etc., CTA may require greater clearances than specified in the diagram. Coordination with Rail Operations will be required.
11. The poles or towers shall be plainly marked with the name, initials, or trademark and the pole numbers, if used, of the Crossing Company. When required by CTA, the Crossing Company shall place, on all crossing structures located on CTA property.
12. In general, lines shall be arranged in the order of their operating voltages, conductors of the greatest voltage occupying the highest position. Where lines of lower voltage are permitted to cross over circuits of higher voltage, their mechanical strength shall conform to that required for the higher voltage lines.
13. Splices shall not be made in the crossing span, and preferably not in the adjacent spans, which are depended upon for withstanding the longitudinal tension of the crossing conductors. Taps shall not be made in the crossing span. If a splice or tap is made in any conductor in the span adjacent to the crossing span, it shall, where practicable, be placed at a point nearer to the crossover support than is the nearest conductor crossed over.
14. Cradles, baskets, and overhead bridges are generally not acceptable and shall not be used except under unusual conditions where it is economical to build such a structure of sufficiently substantial nature and when approved by CTA. Drop outs shall not be used.
15. The crossing construction shall be subject at all times to the inspection and approval of CTA.



16. All parts of the supporting structures of the crossing span shall be inspected annually by the owner and all defective parts shall be promptly restored to a safe condition.
17. The details of construction and maintenance of the crossing, unless otherwise specified herein, shall be in accordance with the current specifications of the National Electrical Safety Code, except when modified construction is permitted by CTA.
18. The Crossing Company shall submit plans showing proposed construction for review and approval with its application. The plan shall also include details of future maintenance. All requirements in [Section 2](#) are required prior to commencement of construction.

11.2.5 Bridge Girder Erection Over CTA Tracks

Bridge girder erection activities have the potential to run significantly longer than time durations between trains. Per [Section 3.9](#), CTA prohibits bridge girder erection activities during rush hour periods. These activities are further constrained to overnight hours to avoid impacting rush hour periods and to take advantage of non-revenue hours, or longer headways. Any significant delay will result in enforcement of [Section 3.8](#). Adjacent Construction Owner/Contractor may request a scheduled Line Cut or Single Track through a Variance Request. CTA reserves the right to require a scheduled Line Cut or Single Track for performance of these activities when CTA determines Contractor cannot meet Condition 1 or 2 as described below without incurring significant train delays or risk to Operating System. The Adjacent Construction Owner/Contractor is fully responsible for all costs associated with any scheduled Line Cut or Single Track.

CTA will allow trains to pass underneath a bridge girder only after it is assured the girder is stable per one of the conditions shown below. In the CPP, the Erector's Engineer in Responsible Charge must clearly delineate the requirements for each of the condition. Coordinate with IDOT or other controlling agency for their roadway requirements.

Condition 1:

- Girder is erected and stable on its own without assistance from crane. As determined by Erector's Engineer in Responsible Charge with structural analysis.

Condition 2:

- Girder is held by crane with crane utilization less than or equal to 0.67 of the lift capacity, and;
- Girder is set on two supports. Where the support is a splice, minimum number of erection pins/bolts must be installed in the web to support 150% of the girder dead load, but no less than two (2) erection pins/bolts; and two erection pins/bolts near the extreme bolt holes of the top and bottom flange of each connected member.



In addition to the general submittal requirements per [Section 2](#), all bridges above CTA tracks shall be considered as Class B bridge per NHI Publication No. FHWA-NHI-15-044 Engineering for Structural Stability in Bridge Construction Chapter 8 Section 6. Bridge girder erection CPP shall comply with all requirements as a Class B bridge. For major bridge projects, existing bridge demolition and new bridge construction may be done in different stages, and within the specific stage, removal for multiple spans may be done in different phases. The CPP submitted to CTA shall include all stages/phases as a whole for review.

11.2.6 Miscellaneous Temporary Structure Adjacent to CTA Tracks

Tuckpointing, façade inspections, ComEd line work, or other activities requiring scaffolding, swing stages, crawler cranes, man lifts, etc. next to CTA tracks. These cases do not require an engineering review but will require a safety department review, flaggers, and inspectors on site for these activities. Refer to [Section 3.7](#) for safety requirements.

For swing stages, overnight or longer periods require the platform to be parked in its storage position and secured to the structure to prevent movement or damage due to wind. Trailing ropes and cables should be securely stored, protective devices locked onto ropes, electric cables disconnected from supply and if air operated air-lines, disconnected and pressure released. The control box should be removable, unless an alternative method is used to isolate power to the cradle, for safety and security when the suspended scaffold is not in service.

11.2.7 Tower Crane Over CTA Tracks

Tower crane over CTA tracks typically does not require an engineering review but typically will not be allowed without an electronic limiter. If electronic limiter is used, CTA safety will verify the limits for the picks to ensure it will not encroach the CTA R.O.W. Refer to [Appendix A](#) for Tower Crane Checklist.

11.2.8 Small Unmanned Aircraft System

Unmanned Aircraft Systems or Drones are not to be flown at any time on CTA property, as defined per Basic Safety Envelope, without express authorization from CTA. Request shall be submitted using the Variance Request Form attached in ACM [Appendix H](#).

11.3 CONSTRUCTION ADJACENT TO CTA ELEVATED TRACK AND OTHER STRUCTURES

This section includes requirements regarding construction and excavation adjacent to CTA tracks supported by open and closed deck steel and concrete structures, as well as ballasted tracks supported by retaining walls. Construction and excavation adjacent to other CTA facilities and structures are to follow this section, as applicable, unless otherwise allowed by CTA. New constructions adjacent to CTA elevated track and other CTA facility structures must be outside



the CTA property line and maintain a minimum 2'-0" clearance if the property line permits a smaller clearance.

11.3.1 Excavation Shoring NOT Required

For construction adjacent to CTA elevated track structures where no excavation is required, [Section 3.9](#) shall apply and any other Sections that are applicable.

11.3.2 Excavation Shoring Required

For construction adjacent to CTA elevated track structures where excavation is required, the Zone of Influence diagram shown in **Figure 11 - 4** shall be used instead of **Figure 3 - 1**. All other requirements of this Manual shall apply, where applicable, except those specifically modified under this Section. Excavation adjacent to other CTA facilities and structures can also use **Figure 11 - 4**. Refer to [SECTION 4](#) through [SECTION 9](#) for ERS design requirements.



Zone 1:

- **Excavation is prohibited unless written permission is given from CTA to shore the existing track structure column. Refer to [Section 11.4](#).**



Zone 2:

- **Temporary ERS shall be designed with horizontal pressure from the footing surcharge.**
- Bottom heave shall also be evaluated per [Section 9.3.2](#) when soil condition warrants.



Zone 3:

- Temporary ERS need not be designed with horizontal pressure from the footing surcharge.
- Excavation beyond the Zone of Influence line within Zone 3 shall not be open cut.

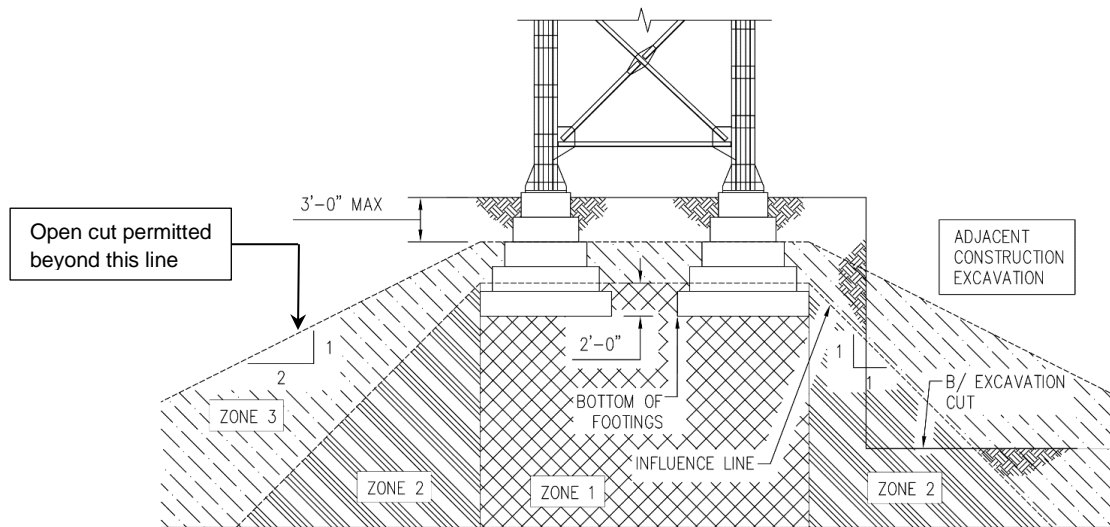

Figure 11 - 4: Elevated Track Structure Footing Zone of Influence

The bearing pressure of the track structure spread footing shall be calculated with (for other CTA facilities, use facility specific loads):

- Dead Loads: track structure, trackwork, track level footwalk, equipment platforms (if any), railings, station structure, and canopy (if any)
- Live Loads: rapid transit cars, railbound crane train (if requested by CTA), 100 psf live load on station platform and all other pedestrian areas (if any), 30 psf live load on canopy (if any), 200 psf live load on track level footwalk and/or equipment platforms (if any)
- Impact Loads and Rocking Effects: shall not be considered for rapid transit cars
- Wind Loads: on structures, rapid transit cars, canopy (if any)
- Snow Loads: on structures, canopy (if any)
- Longitudinal Force
- Centrifugal Force (if any, on curved tracks)

However, at Owner/Contractor's option, the maximum allowable bearing pressure for the spread footings can be conservatively assumed as 4000 psf. This bearing pressure can be used for the shoring wall design to be conservative and eliminate the need to perform a full analysis/load takedown for the elevated track structures. If the excavation is within the Zone of Influence at a tower bent (i.e., diagonal bracing members are present as shown in **Figure 11 - 4**), the bearing pressure used for the shoring wall design shall be the maximum bearing pressure times 1.5.⁴⁰

If the Adjacent Construction work causes excessive settlement (equals to or exceeds 3/8 inch) to the existing CTA elevated track structures, CTA may require the existing CTA track structure foundation be underpinned and jacked; or excavate to expose the settled foundation, disconnect the column base anchors so that shimming can be installed with superstructure raised. The

⁴⁰See Section 11 Commentary



correction measures shall be designed by the shoring design Engineer in Responsible Charge, reviewed and approved by CTA Engineering on a case-by-case basis.

11.3.3 Deep Foundations

Micropile foundations and caisson/drilled shaft foundations generally are not affected by the adjacent excavation. Shoring designer must provide evaluation of shoring effects on deep foundations. Caution should be exercised during the shoring wall installation and excavation to prevent damaging battered micropiles, or vertical micropiles driven out of tolerances that may become battered. CTA may request excavation under existing pile caps to verify location, angle and based on that the ultimate termination point of Micropiles as part of the design's evaluation of the shoring effects on the CTA structure.

When the proposed adjacent structure deep foundations, such as caissons, are adjacent to CTA micropile foundations, maintain a minimum clearance of 2'-0" from the edge of proposed deep foundations to the outer casing of micropiles.

Open-cut that exposes micropile foundation cap is not permitted without shoring system that resists the lateral forces. Lateral forces can be calculated with the longitudinal and transverse demands as shown in [Section 11.3.2](#). Or at Owner/Contractor's option, shoring system may be designed to resist the full passive resistance acting on the faces of the micropile caps. The soil shall be assumed cohesionless and passive resistance shall be calculated per Rankine's Theory as shown in [Section 5.2.4](#), unless soil can be determined based on Adjacent Construction Project soil borings.

New deep foundations adjacent to existing CTA spread footings will require permanent casings.

11.3.4 Wireline Mounted on Elevated Track Structures

Mounting wirelines on elevated track structures are generally not recommended, unless approved by CTA. The CTA preferred mounting details will be provided if the Variance Request is approved. See [Section 11.3.5](#) for additional recommendations regarding vibration concern on open deck type structures.

11.3.5 Miscellaneous Elements Mounted on Elevated Track Structures

Miscellaneous elements in this Section include lightings, drip pans, etc. elements whose self-weight is neglectable to the track supporting structures. Such work will require engineering, safety review, real estate review, traction power review, as well as needing inspectors and potentially flaggers if the work extends above the ties. Drill fastener holes in the bottom flange of track structures is strictly prohibited. Non-penetrating fasteners shall be provided in locations approved by CTA Engineering. Coordinate with CTA for requirements for right-of-entry. Refer to [SECTION 2](#) for the coordination flowchart.



Based on vibration study⁴¹, the rate of occurrence of the shock and vibration events on open deck type of track structure may be severe and this may impact the wireline and/or miscellaneous elements mounted on the CTA open deck type track structures. Special attention should be paid to minimize the risk of attachments becoming loose. Potential solutions include adding a third mounting bracket to the center of the fixtures, refinement of the bracket design, and reevaluation of the rubber isolator pads, etc.

11.4 ELEVATED TRACK STRUCTURE TEMPORARY SHORING

Temporary shoring structures connecting to CTA elevated track structure columns, cross girders, or stringers to directly carry the Rapid Transit live load is prohibited, unless otherwise permitted by CTA through writing. Coordination Flowchart per [Section 2](#) and Variance Request per [Section 2.2](#) must be followed to obtain the approval. Adjacent Construction Owner, Designer, and/or Contractor shall investigate possible alternatives to avoid shoring the CTA elevated track structure directly.

If no alternate is practical, or as required when excessive settlement occurred to the adjacent CTA track foundation as shown in [Section 10.4](#), in addition to this Manual, the Adjacent Construction Owner, Designer, and/or Contractor will be provided with a copy of the CTA Infrastructure Design Criteria Manual (IDCM) Chapter 7 – Structural, and CTA’s Specifications for track structural shoring and monitoring. These documents must be included as a part of the Contract Document for the Adjacent Construction Project.

The design, construction, and monitoring requirements are provided in the above-mentioned documents in details. In general, the following requirements shall apply:

- Temporary shoring structures to carry Rapid Transit traffic other than Earth Retention System shall be designed as **permanent structures** per *AREMA Manual for Railway Engineering*, latest edition. (i.e., Chapter 15 Part 7 shall not be used.)
- Design methodology for all material used for the temporary shoring structures shall be **Allowable Stress Design (ASD)**.
- Structural analysis of the existing track structures, especially at curved tracks, to determine the temporary shoring structure demands shall consider multiple spans. Typically, from expansion joint to expansion joint which normally consists four (4) to five (5) spans.
- Rapid Transit speed reduction shall not be permitted. All temporary shoring structures must be designed to be able to carry the Rapid Transit live load at full speed (i.e., up to 55 MPH, depending on locations) regardless if the temporary shoring structure is at a station area.

⁴¹“Wabash Vibration Report” by Color Kinetics Mechanical Engineering Department, 2018/07/23



- For steel members, fatigue analysis need not be performed, provided service life of the temporary shoring structures satisfies [Section 1.1](#). However, fatigue detailing is required. Low fatigue resistant details (Detail Category E', E, and D) shown in Table 15-1-9 in *AREMA Manual for Railway Engineering* shall be avoided.
- The stability of the temporary shoring structures shall be checked. Factor of Safety for stability against over-turning shall be greater than 1.5. Factor of Safety for stability against sliding shall be greater than 2.0.
- No welding to existing track structure is allowed. Connection to existing track structures shall be High Strength structural bolts F3125 Grade A325 type 7/8" diameter installed as Slip Critical Condition using turn-of-the-nut method. Use existing rivet holes to make the connection as practicable as possible. The rivet removal procedures are provided in the Specifications.
- The temporary shoring structure design shall not damage or otherwise reduce the quality or life of any portion of the permanent existing structures.
- Temporary shoring structures shall allow elevation adjustments between short train intervals to adjust system settlement and maintain track profile.
- Temporary shoring structure designer shall include requirements for jacking devices in the drawings. The rated capacity of a jack shall be a minimum of 50% greater than the computed required jacking force. Rapid Transit live loads shall not be supported hydraulically.
- Temporary shoring structure Designer and Contractor shall determine the adequacy of existing structure at time of shoring installation to resist the concentrated force imposed through jacking device. Design shall include details to distribute concentrated force, i.e. full depth stiffeners.
- When temporary shoring structures are located on the roadway and may be subjected to vehicle collision, temporary shoring structures shall be designed to withstand vehicle collision force specified in CTA IDCM Chapter 7, or IDOT standard F shape barriers shall be installed to redirect errant vehicles.
- When shoring structures are exposed to impacts of construction equipment only, IDOT standard F shape barriers or other suitable barrier shall be installed.
- Earth Retention Structure shall be in place before erection/installation of temporary shoring structures.
- If multiple bents are necessary to be shored to facilitate the Adjacent Construction Project, temporary shoring structures will not be permitted to be in service concurrently on adjacent bents.



- Monitoring of temporary shoring structure and the existing track structure shall follow the requirements specified in [Section 10](#) with the modifications in CTA Specification 31 09 13 – Geotechnical and Structural Monitoring Instrumentation Part 3 Execution – Data Collection and Processing.⁴²
- After temporary shoring structures are removed, all open holes shall be filled with High Strength structural bolts F3125 Grade A325 type 7/8” diameter installed as Pretensioned Joint using turn-of-the-nut method.

If existing CTA elevated track structure settled more than 3/8” before emergency shoring structure is implemented, CTA may require the settlement be corrected on a case-by-case basis. The correction method may be underpinning the existing foundation, or jack up the settled foundation to the original elevation then shim plates be provided under the column base. The correction method shall be reviewed and approved by CTA Engineering.

11.5 EXISTING CTA FACILITIES

11.5.1 General

Adjacent construction work shall not interfere with any existing CTA structure/facility functions such as station entrances, bus turnarounds, CTA facility/shop entrances, etc. It is recommended that ten (10) feet minimum clearance be provided for all new development next to the adjacent CTA structures to ensure future abilities to inspect and maintain both structures unless additional clearance is required, for example, when impacting station exit, etc.

11.5.2 CTA Subway Vent Shafts Protection or Reconstruction

In no way shall future development incorporate vehicle drive lanes or parking areas over CTA vent shafts.

Where demolition or construction will take place in close proximity to a CTA vent shaft, the vent shaft shall remain open and uncovered during construction at all times. The Contractor shall protect the vent shafts from damage and protect them from construction debris falling into the vent shaft. Typically, this can be achieved by installing a temporary wood structure around the perimeter of the vent shaft, potentially with an access door.

Where the Adjacent Construction proposes to repair/re-profile the sidewalk and CTA vent shafts, CTA typical vent shaft repair guide drawings will be provided after the initial coordination.

⁴²[See Section 11 Commentary](#)



(This page intentionally left blank.)



APPENDIX A – SUBMITTAL CHECKLISTS

SHORING DESIGN CHECKLIST

The shoring designer shall complete, sign, seal, and submit the enclosed Shoring Submittal Design Checklist with the shoring design submittal.

SHORING DESIGN REVIEW CHECKLIST

The submitted Shoring Design Checklist shall be utilized by consultants (independent party for QA/QC per [Section 2.1](#)) as Submittal Review Checklist to aid the review of shoring design submittals.

CONSTRUCTION PROCESS PLAN (CPP) Checklist

The Construction Process Plan (CPP) Checklist shall be utilized by the Contractor and attached to the CPP to aid the review and can be used as a general CTA Inspector's checklist where indicated on the checklist.

CONCRETE PRE-POUR CHECKLIST

Where it is determined that the concrete placement poses a hazard to CTA operations, the following checklist must be filled and submitted to CTA for record. If during the inspection non-compliance are identified, Contractor must bring items into compliance prior to placing concrete. Checklist must only be submitted when all items are in compliance.

TOWER CRANE CHECKLIST

Where it is determined that the Tower Crane Operation poses a hazard to CTA operations, the following checklist must be filled and submitted to CTA for record. If during the inspection non-compliance are identified, Contractor must bring items into compliance prior to operating the Tower Crane. Checklist must only be submitted when all items are in compliance.

TASK SPECIFIC CHECKLIST

Checklists are provided in this Appendix for the CTA Inspectors to complete during inspections. These blank checklists shall be included and attached digitally to the end of the submitted Construction Process Plan as appropriate based on the work. The checklists for CTA Inspectors are digitized to allow filling the checklists with digital devices. Contractor shall ensure the preserve this function when extracting the checklists from the ACM, and attaching them to the submitted CPP.

Various items are marked with  to indicate that a photo shall be taken by the CTA Inspectors to show the corresponding work has been performed per the CPP. The photos shall be sent to CTA via daily reports with a brief description for each photo that includes information such as: time, location, confirmation that the checklist item has been done according to the CPP, and/or issues encountered, etc.



SHORING DESIGN CHECKLIST

Project Name/Location: _____

Submittal Date: _____

Shoring Design Firm: _____

Contractor: _____

Item	Yes/No /NA	Explain if No or NA
Drawings – Checked, Signed & Sealed?		
1. Drawings to-scale?		
2. Plan view is oriented correctly and shows relative position of shoring/excavation and tracks, stationing, bent number, and all pertinent Operating System Facilities (surface and underground)?		
3. Section normal to track(s) shows elevations of track(s), ground surface, excavation subgrade, bracing elements and horizontal clearances?		
4. Dimensions defining the arrangement of all elements of shoring system provided?		
5. Sizes of all shoring elements provided?		
6. All connections detailed?		
7. Specifications for all materials provided?		
8. Specifications and requirements for fabrication and installation provided?		
9. Construction sequence(s) detailing all steps/stages in the shoring installation, excavation, planned installation equipment location and shoring removal provided?		
10. Track monitoring requirements specified?		
11. Impacts to existing drainage addressed?		
Design Calculations – Checked, Signed & Sealed?		
<i>General:</i>		



Item	Yes/No /NA	Explain if No or NA
1. Design calculations provided for all elements of the shoring system?		
2. Calculations for all steps/stages of excavation and support removal?		
3. Shoring designer has verified the accuracy, suitability, and applicability of the information and criteria outlined in the CTA Adjacent Construction Project Manual for the specific application being designed?		
<i>Loading:</i>		
4. Soil loading (active and passive) developed in accordance with Section 5.2?		
5. Groundwater loading developed in accordance with Section 5.3?		
6. Surcharge loading (other than Rapid Transit Live Load Surcharge) developed in accordance with Section 5.4?		
7. Rapid Transit Live Load Surcharge developed in accordance with Section 6?		
8. All required loads considered in shoring analysis?		
<i>Analysis:</i>		
9. Shoring wall analyzed in accordance with Section 7?		
10. Bracing loads determined in accordance with Section 7?		
11. Embedment depth of wall determined in accordance with Section 7?		
12. Bracing system analyzed in accordance with Section 7.6?		
13. Lagging analyzed in accordance with Section 7.7?		
14. Secondary bracing, connections, and stiffeners analyzed and provided in accordance with Section 7.8.2?		



Item	Yes/No /NA	Explain if No or NA
15. Shoring deflection and settlement estimated in accordance with Section 7.9?		
<i>Material Properties and Allowable Stresses:</i>		
16. Material properties and allowable stresses in accordance with Section 8?		
<i>Special Conditions:</i>		
17. Is external dewatering proposed?		
a. If yes, has dewatering been accepted by CTA?		
b. If yes, has a settlement analysis (due to dewatering been provided?		
18. Has the potential for piping been evaluated in accordance with Section 9.3.1?		
19. Has potential for heave been evaluated in accordance with Section 9.3.2?		
20. Has global stability of the shoring system be evaluated in accordance with Section 9.4?		
21. Are tiebacks proposed?		
a. If yes, has CTA accepted their usage?		
b. If yes, are they designed and will they be tested in accordance with Section 9.5?		
22. Are deadmen proposed?		
a. If yes, has CTA accepted their usage?		
b. If yes, has third party approval been granted?		
c. If yes, are they designed in accordance with Section 9.6?		
The following items are to be used for Section 11 only.		
1. Is Adjacent Construction over or adjacent to CTA underground structures and/or underground structures that is within the Zone of Influence in Figure 11-2?		



Item	Yes/No /NA	Explain if No or NA
<ul style="list-style-type: none"> If yes, has Special Monitoring requirements been provided by CTA? 		
<ul style="list-style-type: none"> If yes, has CTA accepted the Adjacent Construction to be minor construction in accordance with Section 11.1.4? 		
<ul style="list-style-type: none"> If yes, has a rigid/stiff support of excavation system been designed? Or has CTA accepted the use of any other system? 		
<ul style="list-style-type: none"> Has tunnel analysis been performed in accordance with Section 11.1.3? 		
<ul style="list-style-type: none"> Has probing been done to locate the existing CTA underground structures? 		
<ul style="list-style-type: none"> Is permanent casing included for caissons/drilled shaft? 		
<p>2. Is Adjacent Construction directly above CTA tracks and/or facilities?</p>		
<p>a. If yes, is CTA train clearance satisfied in accordance with Section 11.2.1?</p>		
<p>b. If yes, is protective measure provided in accordance with Section 11.2.1?</p>		
<p>c. If yes, is pier/foundation wall protection in accordance with Section 11.2.2?</p>		
<p>d. If yes, are requirements for pier/foundation wall formwork included in the Specifications in accordance with Section 11.2.3?</p>		
<p>3. Is Adjacent Construction adjacent to CTA elevated track structures?</p>		
<p>a. If yes, is excavation required that is within the Zone of Influence shown in Figure 11-4?</p>		
<p>i. If yes, has CTA provided necessary information to calculate the bearing pressure? Or allowable bearing pressure is used for the design?</p>		
<p>ii. Is the excavation adjacent to a tower bent and is the 1.5 factor being included</p>		



Item	Yes/No /NA	Explain if No or NA
if the allowable bearing pressure is used?		
4. Is Adjacent Construction adjacent to CTA vent shafts?		
a. Will CTA vent shaft(s) be repaired?		
i. If yes, are typical vent shaft guide drawings filled and submitted to CTA for review?		

 Shoring Designer Signature and IL SE Seal

 Print Name

 Independent Reviewer's Signature and IL SE SEAL

 Print Name

Status:

- No Exceptions Taken
- Make Corrections Noted
- Revise and Resubmit

Attach additional sheets for review comments, as necessary. All additional review comments and their dispositions must be submitted with the checklist to CTA for record.



CONSTRUCTION PROCESS PLAN CHECKLIST

Project Name/Location: _____
 Submittal Date: _____
 Shoring Design Firm: _____
 Contractor: _____

Note: shaded cells are intended for CTA Inspectors.

Item	ACM Section	Yes/No/NA	Explain if No or NA
Contact list included?	2.7(a)		
General Project information included?	2.7(b)		
Table of contents included?	2.7(c)		
Summary of potential changes on site included?	2.7(d)		
CTA Inspectors field verify required.			
<i>CTA Inspector Note: ensure the potential change summary is followed on-site. Include in the daily report to CTA noting any potential changes are made on-site based on the CPP and reasons why changes were made.</i>			
Summary of possible conflicts/issues with actions?	2.7(e)		
CTA Inspectors field verify required.			
<i>CTA Inspector Note: include in the daily report to CTA noting any conflicts/issues encountered on-site and confirm proper actions are taken.</i>			
Description of proposed temporary changes to CTA Operating System.	2.7(f)		
CTA Inspectors field verify required.			
<i>CTA Inspector Note: Coordinate with CTA Operation for safety related procedures/checklists for any changes to CTA Operating System such as Single Track, etc. Include the number of flaggers in the daily report to CTA.</i>			
Material and equipment list with site plan?	2.7(i)		
CTA Inspectors field verify required.			
<i>CTA Inspector Note: Verify and confirm material and equipment match the list in CPP. For example, material would include sheet pile, H pile, timber lagging size and grade, grout, or concrete mix, etc. For equipment, verify the equipment model number, especially for crane or any weightlifting equipment that may foul the CTA tracks.</i>			



Detail construction sequences with drawings, and how each activity affects the normal operation.	2.7(g) (i) (k)		
	CTA Inspectors field verify required.		
<i>CTA Inspector Note: Verify and confirm the construction sequences are followed and if any deviations occur on site other than what is included in the potential changes in the CPP as shown in ACM Section 2.7(d).</i>			
Detail schedule.	2.7(h)		
	CTA Inspectors field verify required.		
<i>CTA Inspector Note: Verify and confirm the percentage of completion of each activity in the daily report to CTA. Confirm if the Adjacent Construction is on schedule.</i>			
Quality control plan, Construction Verification.	2.7(l) (m) (o) (n) 2.8		
	CTA Inspectors field verify required.		
<i>CTA Inspector Note: Verify and confirm the quality control plan is followed such as Welding Procedure Specification is followed, concrete break test, etc. Where Construction Verification is required for the work and shown in the CPP, verify, witness, and confirm hold point(s) are provided and the Engineer In Responsible Charge is on-site performing the verifications.</i>			
Monitoring plan and contingency plan.	2.7(p) (q)		
	CTA Inspectors field verify required.		
<i>CTA Inspector Note: Verify and confirm monitoring plan included in the CPP is followed. Verbally confirm with the surveyor after each reading is taken. If no settlement or settlement less than 1/16" is confirmed, include the information in the daily report. If settlement greater than 1/16" but less than 3/16" is confirmed, report to CTA Engineering immediately via email with the confirmed settlement reading. If reading equal to or greater than 3/16" is confirmed, the actions shown in the contingency plans shall be followed per the CPP.</i>			
Job Hazard Analysis.	2.7(r)		
	CTA Inspectors field verify required.		
<i>CTA Inspector Note: Coordinate with CTA Safety and report any safety violation, if any, in daily report, as necessary.</i>			



CTA INSPECTOR GENERAL INSPECTION CHECKLIST



Project Name/Location: _____

Inspection Date: _____

CTA Inspector Name: _____





Contractor
 Superintendent Name: _____

Note: This CTA Inspector Checklist is required to be attached and completed for all CPP. CTA Inspectors are recommended to complete these inspection checklists with assistance/coordination with the Contractor’s superintendent.

ITEM	ACM Section	Yes/No/NA	Explain if No or NA
Do you have a copy of the approved Construction Process Plan?	2.7 Appendix A		
Is the GC’s Superintendent or quality representative on site?	N/A		
Did you attend or confirm that the Contractor conducted a briefing/pre-activity meeting on the CPP prior to the start of work.	2.7		
<i>CTA Inspector Note: CTA Engineering will provide briefing points for Contractor upon review of the CPP. CTA Inspectors shall ensure these briefing points are understood by all parties doing the work.</i>			
Did you verify and confirm that the Contractor has obtained the necessary documents such as Right of Entry Document, Rail Safety Training, etc?	2 3.4		
 If flaggers are required for the work, did you verify the number of flaggers?	3.9		
If single track/reroute, or line cut is required for the work, did you coordinate with CTA Train Operations and CTA safety?	3.9		
If CTA track/facility structure monitoring is required, did you verify and confirm with the Contractor that the baseline monitoring had been conducted?	10.3 10.6		
 If identifying underground utilities is required, did you witness and confirm all existing utilities, especially for CTA utilities, have been identified in the field prior to any excavation?	3.6		
Did you verify and confirm that Contractor personnel have the proper Personal Protection Equipment, including fall protection, when required?	3.7		



TEMPORARY EARTH RETENTION STRUCTURE INSPECTION CHECKLIST

Task Specific Item	ACM Section	Yes/No /NA	Explain if No or NA
 Did you verify the distance from edge of the ERS system/excavation to the center line of adjacent track or edge of CTA track/facility structures matches the approved CPP?	2.7(a)		
<p><i>CTA Inspector Note: OUC typically permits to move the utility alignment for up to 2 feet in all directions which may result in ERS system moving 2 feet closer to CTA structures. However, this is not allowed in the ACM per Section 2.1.</i></p>			
Did you verify the delivered material such as sheet piles, and H piles, equal to or exceed the minimum required length per the Drawings?	N/A		
 Did you verify if there are markings on the sheet piles or H piles that can indicate embedment depth and excavation limits? If not, did you confirm with the Contractor what is the method used to determine these depths?	N/A		
 If sheeting piles are cold-formed type and ground water is anticipated to be retained, did you witness or verify if Contractor applied interlock sealant on the installed sheet piles?	8.1.2		
<p><i>CTA Inspector Note: cold-formed type sheet piles are usually designated as SKL, SKS, or SKZ types. If cold-formed sheet piles are designed to retain groundwater, CTA Engineering will ensure the requirement to apply interlock sealant is clearly shown in the drawings. CTA Inspector needs to review the drawings and ensure this is implemented in the field.</i></p>			
If soldier piles/H piles require splices, or waler/strut connections contain welded joints, did you verify the welder's certificates, and the welding procedure specification is on-site and followed such as pre-heat? After welding is completed, did you witness any visual inspection done to ensure the weld size and length comply with the Drawings and no other obvious defects that may affect the soundness of the weld.	1.4 AWS D1.1		
 If soldier pile ERS is used, did you verify that timber laggings were installed with the maximum excavation lift as recommended by the Geotechnical Engineer? Did you verify that grout was poured behind the laggings to fill the voids?	3.1 Zone 3 4.2.2		
<p><i>CTA Inspector Note: when micropiles are permitted to be used as soldier piles for the ERS, CTA Inspector shall complete the Micropile Checklist.</i></p>			



FLAGGER VERIFICATION/RAIL SERVICE BULLETIN CHECKLIST

Project Name/Location: _____



Job Order Number: _____

Flagger Confirmation Number: _____

Rail Service Bulletin Number: _____

Date: _____

Note: An approved Flagging Request form/spreadsheet, and Rail Service Bulletin Request if Single Track/Reroute is required, shall be used to complete this checklist. The above-mentioned Job Order Number and Confirmation Number are shown in the Flagging Request form/spreadsheet.

ITEM	ACM Section	Yes/No/NA	Explain if No or NA
Did you verify a Confirmation Number is provided in the Flagging Request form/spreadsheet for today's work?	N/A		
Did you verify and confirm the Contact Person shown on the approved Flagging Request is on-site.	N/A		
 Did you verify and confirm the correct number of flaggers is on-site and positioned per the Flagger Manual?	N/A		
If Single Track/Reroute is required for the work, did you verify and confirm the Rail Service Bulletin has been approved?	N/A		
If Single Track/Reroute is required for the work, did you verify and confirm the Contractor Person in Charge/Requestor is on-site?	N/A		
 If Single Track/Reroute is required for the work, did you verify and confirm the correct number of additional personnel and equipment are on-site and installed, such as additional signal, traction power isolation, etc?	N/A		

Additional Field Notes for CTA Inspector:





FIELD WELDING CHECKLIST

Task Specific Item	ACM Section	Yes/No /NA	Explain if No or NA
Did you confirm if Contractor’s Superintendent and Quality Representative/Certified Welding Inspector were on site?	2.7(l) 7.8.6		
Did you verify and confirm if welding performed was according to the approved welding procedure?	7.8.6		
Did you verify and confirm if welding inspector AWS Certified Welding Inspector (CWI)?	7.8.6		
Were the conditions acceptable during the welding process?	7.8.6		
<i>CTA Inspector Note: No welding in water, rain, or snow, high winds, and not under 0°F without a shelter. Refer to AWS D1.1 Article 5.11 for more information.</i>			
Did you visually verify and confirm if the surface of steel was clean and clear, paint, water, or grease?	7.8.6		
Did you verify and confirm with the Welding Inspector that he/she ascertain that only materials conforming to the requirements of the CPP were used?	2.8		
Did you verify and confirm if the welders had a way to prove their amperes and voltage was correct; i.e., calibrated gauges or a calibrated clamp meter?	7.8.6		
Did you verify and confirm if at the start of welding on the piles, was alignment and fit-up acceptable?	7.8.6		
Did you verify and confirm if the welding inspector required requalification of any welder, welding operator, or tack welder whose qualifications are not current as per welding code?	7.8.6		
Did you verify and confirm if the welders were working within his qualification limits? Is the welder certificate current as most field welders are qualified for only one year at a time?	7.8.6		
<i>CTA Inspector Note: Welder’s Performance Qualification Test Report may not be within one year, however, welders are qualified as long as their continuity log shows the welders have been performing the qualified welds.</i>			
During welding, did the CWI check the following: a. Preheat and Interpass Temperature b. Cleaning, Chipping, Grinding, and Gauging c. Structural Discontinuities	7.8.6		







CAISSON/DRILLED SHAFT/SECANT PILE CHECKLIST

Task Specific Item	ACM Section	Yes/No /NA	Explain if No or NA
Did you confirm if Contractor's Superintendent and Quality Representative in Geotechnical Engineering were on site?	2.7(l)		
Did you confirm if the testing agency Inspector/Engineer is on site performing full time inspection of the whole caisson work?	2.7(l)		
 Did you confirm if the probing operation was done to identify the edge of CTA's adjacent structures prior to the caisson work?	11.1.4		
 If required by CTA, did you attend the pre- and post-inspection was done for the CTA substructures? If required by CTA that continuous monitoring is required for the CTA substructures, is there enough CTA Inspectors to provide inspections for the caisson drilling on the surface level and continuous monitoring in the CTA substructures?	11.1.4		
<i>CTA Inspector Note: Based on the type, depth, location, and soil layers of the adjacent caisson installation, CTA Engineering may determine a pre- and post-inspection of the CTA substructures/subway tunnels are required. Pre-inspection requires a walkthrough to identify and document all existing cracks and their measurements (width, length, etc). Post-inspection would verify if existing crack measurements increased. If continuous monitoring is required inside the CTA subway tunnels, depending on the subway tunnel layout, multiple CTA Inspectors are needed to provide continuous monitoring when special inspection and monitoring is required per 11.1.4.</i>			
When shown in the CPP that permanent casings are required, did you verify if permanent casing wall thickness and lengths comply with the CPP?	11.1.4		
When permanent or temporary casings are used, did you coordinate with the Contractor's superintendent to confirm the drill auger did not extend beyond the bottom of the casings in weak soil layer?	11.1.4		
 When there is a line of caissons longitudinally adjacent to the CTA underground structures, did you verify and confirm that no more than one shaft is excavated and open at any time?	11.1.4		
<i>CTA Inspector Note: This requirement may be waived by CTA Engineering when the two shafts open are not next to each other and permanent casings are used.</i>			
If de-watering is permitted for the caisson construction, did you verify and confirm Contractor provided continuous monitoring on the adjacent CTA structures? Did you make sure the amount of water pumped did not exceed 900 gallons?	9.2		





MICROPILE CHECKLIST



Task Specific Item	ACM Section	Yes/No /NA	Explain if No or NA
Did you confirm if Contractor's Superintendent and Quality Representative in Geotechnical Engineering were on site?	2.7(l)		
Did you confirm if the micropile design Engineer in Responsible Charge is on site performing full time inspection of the whole micropile work?	2.7(l)		
 Did you confirm if the probing operation was done to identify the edge of CTA's adjacent structures prior to the micropile work?	3.6 11.1.4		
 Did you verify and confirm the installation method is Rotary Duplex Drilling method?	11.1.4		
Did you verify and confirm with Contractor's Superintendent that a CCP briefing was conducted prior to the work so that drill rig operator is familiar with the extent/depth of the <u>weak</u> soil layer, and is aware the drill bit shall not extend beyond the bottom of the casing in weak soil layer?	11.1.4		
Did you verify and confirm with Contractor's Superintendent that a CCP briefing was conducted prior to the work so that drill rig operator is familiar with the extent/depth of the <u>competent</u> soil layer, and is aware the drill bit shall not extend beyond the bottom of casing exceeding the maximum distance shown in the CPP?	11.1.4		
 Did you verify and confirm with the installer that flushing fluid/air pressure is continuously monitored?	11.1.4		
Did you verify and confirm with Contractor's Superintendent that a CCP briefing was conducted prior to the work so that installer understands external flushing shall be continuous monitored and if external flushing occurred drilling shall be stopped?	11.1.4		
 Did you verify and confirm temporary shoring material was on-site and ready to be installed when settlement occurs per the Supplement Monitoring in Section 10.4 ?	10.4		
Did you familiarize yourself with ACM Section 10.4 for the Supplemental Monitoring when it is required?	10.4		
<i>CTA Inspector Note: micropile installation, especially when it is in close proximity to CTA elevated track structure shallow foundations, require extensive monitoring to verify if any settlements occurred. A</i>			



JACK-AND-BORE / HORIZONTAL DIRECTIONAL BORING CHECKLIST

Task Specific Item	ACM Section	Yes/No /NA	Explain if No or NA
Did you confirm if Contractor's Superintendent and Quality Representative in Geotechnical Engineering were on site?	2.7(l)		
 Did you verify and confirm that all CTA underground utility locations have been field verified by potholing when required?	2.8 3.6 4.4		
Did you verify and confirm that casing pipes are used and consistent with the dimensions shown in the CPP regarding wall thickness, diameter, and length?	4.4		
If casing pipe requirement is waived, did you verify with CPP and confirm a signed and approved copy of Variance Request is attached to the CPP?	3.2		
Did you verify and confirm with the Contractor that all mitigation measures have been properly taken as shown on the approved Variance Request?	3.2 Appendix H		
<i>CTA Inspector Note: When a Variance Request is approved to waive the casing pipe requirement, mitigation measures would include increased carrier pipe thickness, additional corrosion protective coating, or additional capacity for the splice welds, etc. CTA Inspector shall visually verify if mitigation measures are taken properly. For example, CTA Inspector could request the welding inspection report for record.</i>			
Did you verify and confirm that water or slurry under pressure (jetting) or puddling was not used to facilitate boring, pushing, jacking operations, or HDD operations?	4.4		
Did you confirm with the Contractor's Superintendent that the Jack and Bore operations shall be continuous on a 24-hour per day basis?	4.4		
 For auger boring method, did you verify that the front of the pipe was provided with mechanical arrangements or devices that prevent auger from leading the casing?	4.4		
 For auger boring method, did you verify and confirm that the over-cut by the cutting head/auger did not exceed the outside diameter of the casing pipe by more than one-half inch?	4.4		







Task Specific Item	ACM Section	Yes/No /NA	Explain if No or NA
 For jack-and-bore construction, did you verify if the jacking equipment is properly installed?	3.2 Appendix H		
<p><i>CTA Inspector Note: CTA Inspector shall pay extra attention when the jacking pit is within the CTA Zone of Influence, especially the reaction piles are also a part of the ERS retaining soil and track structures. The forces applied to the reaction piles are in the same direction to the soil load/train surcharge. CTA Engineering will verify the reaction piles are designed with the jacking equipment operating pressure and show such information in the CPP. Contractor shall have a gage installed so that the jacking pressure can be continuously monitored. CTA Inspector shall confirm that the jacking pressure is being continuously monitored by the Contractor and the jacking pressure does not exceed the design especially when obstruction is encountered.</i></p>			
Did you coordinate and confirm with the Contractor Superintendent on the actions required when an obstruction is encountered during the installation and it becomes evident that it is impossible to advance the pipe? Is the equipment on-site to support such actions such as grouting machine, etc?	4.4		
 For horizontal directional drilling, did you coordinate and verify with the Superintendent on the method to verify the advancing of borehole, including angles, depths, exact location of the exit ditch, pilot hole diameter, etc?	4.5 (6) (8)		
 For horizontal directional drilling, did you coordinate and confirm that Contractor was monitoring the actual use of bentonite slurry during boring operation to determine the slurry loss, and how the bentonite slurry return was calculated?	4.5		
Did you verify and confirm the monitoring requirements specifically for Jack-and-Bore and HDD construction are included in the CPP and followed? Also refer to the Monitoring Checklist.	4.5 (9) 10.3 (i) (i)		
Checklist Completed by (Print / Signature):			

Additional Field Notes for CTA Inspector:





MONITORING CHECKLIST

Task Specific Item	ACM Section	Yes/No /NA	Explain if No or NA
Did you confirm if Contractor's Superintendent and field instrumentation specialist were on site?	10.1		
Did you verify and confirm that the baseline readings have been done?	10.3 (a)		
<i>CTA Inspector Note: The 3-day average baseline reading is a recommendation and optional. However, the baseline reading method must be consistent with what is shown in the CPP.</i>			
 Did you verify and confirm that all the material/equipment needed to implement the contingency plan is on-site?	10.4		
Did you verify and confirm verbally with the surveyor after each reading is taken on the amount of movements?	10.3 (b)		
<i>CTA Inspector Note: Verify and confirm monitoring plan included in the CPP is followed. Verbally confirm with the surveyor after each reading is taken. If no settlement or settlement less than 1/16" is confirmed, include the information in the daily report. If settlement greater than 1/16" but less than 3/16" is confirmed, report to CTA Engineering immediately via email with the confirmed settlement reading. If reading equal to or greater than 3/16" is confirmed, the actions shown in the contingency plans shall be followed per the CPP.</i>			
 Did you verify and confirm the monitoring is done on a daily basis, before and after each shift before the excavation reaches the design elevation?	10.3 (b)		
 After monitoring frequency is reduced (7) days after excavation reaches final the design elevation, did you verify and confirm the monitoring frequency is back to daily, before and after each shift when conditions warrant?	10.3 (e)		
<i>CTA Inspector Note: Conditions include: modifications are made to shoring structures, weather condition changes such as heavy rain, freezing temperature and thawing temperature, readings that hit the warning limits and others as directed at the sole discretion of CTA. CTA Inspector may coordinate and confirm with CTA Engineering on the conditions on-site.</i>			
 If shoring removal is permitted, did you verify and confirm the monitoring frequency is back to daily, before and after each shift during the shoring removal process?	10.3 (f)		
 Did you verify and confirm the monitoring continues after excavation has been backfilled weekly for a minimum of four weeks?	10.3 (g)		









HANDRAIL/GUARDRAIL AND WALKWAY CHECKLIST

Task Specific Item	ACM Section	Yes/No /NA	Explain if No or NA
Did you confirm with Contractor’s Superintendent that the temporary handrail/guardrail and walkway are regularly inspected and maintained? (Write information on inspection/maintenance frequency in the comment box.)	3.11		
Did you confirm with the Contractor’s Superintendent that a brief safety walk is done at the end of the shift before construction site is shut down?	3.11		
 <p><i>CTA Inspector Note: It is recommended that CTA Inspectors witness and participate the safety walk at least twice a week and provide summary on the safety walk. CTA inspectors may also independently verify if there are any protruding objects, loose boards, etc. if the temporary walkway is accessible during the site visit.</i></p>			
The following checklist items are required when a high wind event is forecasted. High wind event is defined as: defined as: (1) wind speed equal or greater than 40 mph lasting one hour or longer, or (2) wind speed equal or greater than 58 mph for any duration.	3.11		
Date of the forecasted high wind event: _____	3.11		
<p><i>CTA Inspector Note: The date of completion of the following items shall be before the date of the high wind event.</i></p>			
Did you confirm with the Contractor’s Superintendent that he/she is aware a high wind event is forecasted?	3.11		
 Did you confirm with the Contractor’s Superintendent has coordinated with the temporary structures designer of record to evaluate if any additional measures should be taken to secure the temporary structures against the high wind event? If yes, did you confirm or witness the measures have been implemented before the end of the shift.	3.11		
 Did you witness/participate the required safety walk prior to a forecasted high wind event with the Contractor to ensure the temporary structures are fully secured against the high wind?	3.11		
Checklist Completed by (Print / Signature):			







Additional Field Notes for CTA Inspector:



CONSTRUCTION EQUIPMENT CHECKLIST

Task Specific Item	ACM Section	Yes/No /NA	Explain if No or NA
Did you attend the construction equipment demonstration and have knowledge on all the operational constrains?	3.9.1		
 Did you verify the Construction Equipment on-site matches the brand and model number attached in the CPP?	2.7 w. 10) 3.9.1		
 Did you confirm with the Contractor's Superintendent all construction equipment on-site is properly maintained and inspected?	3.9.1		
<i>CTA Inspector Note: Take photos on the maintenance log or inspection log, or any tags/plates available on the equipment.</i>			
 Did you confirm with the Contractor's Superintendent or the equipment operator direct supervisor that a copy of the equipment operation manual is on-site and available that matches what is submitted in the CPP.	3.9.1		
 Did you verify the operators' qualification cards that should be in compliance with OSHA 1926.1427?	3.9.1		
Did you confirm with the Contractor's Superintendent that the platform/ground levelness is within 1 percent grade where the equipment operates on.	3.9.1		
 If the equipment operates on cribbing, or any other type of temporary platform, did you observe restraining devices used to secure the platform?	3.9.1		
Did you verify if the construction equipment operators and their supervisors completed the accident prevention course?	3.9.1		
 Did you confirm a qualified designated person is on-site to determine and control safety of the equipment operation? Did you observe the designated person use hand signal to direct the operators on equipment operations?	3.9.1		
 If there are additional operational constrains and requirements imposed by the SE review, did you make sure the qualified designated person has knowledge of such requirements and they are being followed?	3.9.1		
When required per CPP, did you confirm the required hold-down device is in place for the construction equipment?	3.9.1		



Task Specific Item	ACM Section	Yes/No /NA	Explain if No or NA
 Did you confirm with construction equipment operators and their supervisors that when a passing train is present, construction equipment is not permitted to operate within and above the CTA Train Envelope?	Appendix B 3.9.1		
 If the equipment is excavator mounted with a mast, did you confirm a mast foot is installed and used to support the mast on sound ground/platform?	3.9.1		
 If the equipment is excavator mounted with a mast, did you observe and confirm the mast is fully retracted before any movements such as swinging, rotating, or traveling.	3.9.1		
 If the equipment is excavator mounted with a mast, did you observe and confirm the mast is always within ground/platform limit as the equipment swings/travels.	3.9.1		
 If the equipment is excavator mounted with a segmented mast assembly, did you confirm the mast is not extended taller than what is required for the work?	3.9.1		
 If the equipment is excavator mounted with a mast, did you confirm with Contractor's Superintendent that no modifications have been made that are different from what is approved in the CPP?	3.9.1		
<i>CTA Inspector Note: Take photos of components such as counterweights, undercarriage, mast, mast foot, etc.</i>			
Checklist Completed by (Print / Signature):			

Additional Field Notes for CTA Inspector:



CONCRETE PRE-POUR CHECKLIST

User Note:

- Marks indicate compliance with documents submitted and accepted by CTA. N/A indicates not applicable.
- Inspectors 1, 2 and 3: shall be Designer of Record, Site Superintendent, QA Inspector

Date:	Time:	Temperature:	Weather:	Wind Speed:
--------------	--------------	---------------------	-----------------	--------------------

Location Description:		
Owner Project No.		
Owner Project Name:		
CTA Project #:	CTA LOCID:	CTA Line:
Mix Design #:		Formwork Design Pressure:
Design Pour Rate:		
Formwork Design Pressure		

FORMS	Inspector 1	Inspector 2	Inspector 3
Wind speed is less than Design Wind Speed			
Approved shop drawings are at site			
Support and Bracing are outside CTA train clearance envelope			
Formwork Concrete Design Pressure			
Scheduled Pour Rate			
Formwork is installed per shop drawings			
Temperature is at or above design temperature			
Concrete mix being used matches design mix			

Inspectors	Signature	Time	Date
Formwork Designer of Record			
Superintendent			
QA Inspector			



TOWER CRANE CHECKLIST

This checklist provides the basic requirements for safe operations of a tower crane. Tower crane users should consult manufacturers, suppliers and owners on operations and safety requirements and address any concerns before using the equipment. This checklist is non-exhaustive, and users are recommended to make the necessary customization to suit your work processes and conditions at workplace.

S/N	Items		Remarks
A. Tower Crane Approved For Use			
1	Tower Crane is approved by Ministry of Manpower (MOM).	Yes / No	
2	Tower Crane has a valid Lifting Machine (LM) certificate (issued less than 12 months ago).	Yes / No	
B. General Requirements			
3	Tower Crane is provided with markings of the Safe Working Load, serial number and LM number.	Yes / No	
4	Safe access and egress are provided to the crane operator.	Yes / No	
5	A load capacity chart is displayed in the operator cabin.	Yes / No	
6	Operator crane cabin is provided with a locking mechanism so as to prevent unauthorized entry.	Yes / No	
7	A safety bar is fitted across the operator's cabin window where there is likelihood of the operator falling through it.	Yes / No	
8	Fire extinguisher is fit for use and provided in the operator cabin.	Yes / No	
9	An updated Operation and Maintenance logbook is available in the operator cabin.	Yes / No	
10	Manufacturer Operating Manual and Maintenance Manual are made available.	Yes / No	
11	Tower Crane is adequately grounded or protected against lightening.	Yes / No	
C. Other Visual Checks			
12	Load charts and other symbols are available and visible.	Yes / No	
13	Hydraulic fluid level is sufficient.	Yes / No	
14	Slewing oil level is sufficient.	Yes / No	
15	All mounting bolts are in good condition.	Yes / No	
16	Hydraulic system is free of leaks.	Yes / No	
17	Boom sections are free of cracks or dents.	Yes / No	
18	Main and auxiliary wire ropes are well lubricated and that there are no visible defects such as broken wires, kinks, excess wear, crushing etc.	Yes / No	
19	Winches, pulleys, and wire ropes are in good working condition.	Yes / No	
20	Crane hook is provided with a safety catch to prevent displacement of the sling or load from the hook.	Yes / No	
D. Safety and Operational Devices			
21	Load radius indicator with warning alarm is installed.	Yes / No	
22	Jib angle indicator is provided (For Luffing Jib Tower Crane).	Yes / No	
23	Emergency stop button, which will terminate the operation of the crane engine, is installed in the operator cabin and correctly identified.	Yes / No	



24	Effective braking mechanisms for the following is maintained:		
	(a) Hoisting	Yes / No	
	(b) Derricking	Yes / No	
	(c) Slewing	Yes / No	
	(d) Trolley Travelling	Yes / No	
25	Hoisting Limiter to prevent over-hoisting of the hook block is functional.	Yes / No	
26	Trolley Travelling limiter to prevent over-travelling of trolley is functional.	Yes / No	
27	Limit switches to prevent over-derricking and over-lowering of jib (For Luffing Jib Tower Crane) is functional.	Yes / No	
28	Slewing limiter to restrict slewing of crane is function.	Yes / No	
29	Overload Limiter to prevent overlading of crane is functional.	Yes / No	
30	Load Moment Limiter to prevent over-turning moment is functional.	Yes / No	
31	Anti-collision devices are tested to stop the tower crane's operation such that the crane-to-crane interference must be maintained at not less than 3 meters (approximately 10 feet).	Yes / No	
32	Wind anemometer is installed and is in good working condition.	Yes / No	
33	Adequate aircraft warning lights and/or chequered white and red flags are provided.	Yes / No	
E. Maintenance			
34	Data logger for recording key operating parameters of the crane is functional.	Yes / No	
35	Tower Crane has a regular maintenance program that is in accordance with manufacturer's specifications.	Yes / No	
36	Maintenance work on the Tower Crane is carried out by Competent Persons.	Yes / No	



IC-SOP-P002 CHECKLIST



PROJECT TITLE: _____

LOCATION/ACTIVITY: _____

EXHIBIT A REV. 0 IC-SOP-P002

IC-SOP-P002 Extended Duration Construction Slow Zones without Flaggers

Check List – check each applicable box

- Construction activity adjoining, above or beneath the trackway that has the potential for personnel, material or equipment to accidentally intrude upon a train's clearance envelope
- Excavation under or adjacent to any ballasted track or elevated, subway or earth retention structure
- Any shoring required of an elevated track structure
- Profiling and/or lining of ballasted track
- Partial loosening or removal of any track element in advance of track renewal (e.g., steel or timber guards, restraining rails, spikes, clips, anchors, lag screws, track bolts, shims, plates...)
- Partial removal or temporary repositioning of any traction power elements (e.g., contact rail chairs, taps, pot heads, cables, rail and/or structure bonds)
- Partial loosening or temporary relocation of any signal or communication system cables, conduits and equipment
- Incomplete installation of new materials or fasteners
- Temporary storage of any materials in the trackway (e.g., on footwalk, platforms, between rails)
- Construction activities with potential to cause storm water flooding of the trackway
- Other activity that may pose a risk to safe operations,
 Describe: _____

Submitted by (name, title and employer – please print):

Date _____



(This page intentionally left blank.)



APPENDIX C – SAMPLE CALCULATIONS

Disclaimer Note:

Sample calculations are intended as guideline for the designer. In no way are these calculations intended to be mistake free and applicable to every project. The project designer is to take full ownership of calculations that they submit and cannot hold CTA liable for any mistakes or non-project application of details contained within these sample calculations.

EXAMPLE 4.1 – BENDING STRENGTH OF THREADED MICROPILE CONNECTIONS

PROBLEM:

DETERMINE THE BENDING CAPACITY FOR THE THREADED MICROPILE CONNECTION SHOWN BELOW FOR THE 7" Φ X 0.408" WALL THICKNESS CASING WITH THE REFERENCE SHOWN IN SECTION 4 COMMENTARY. ("*Bending Strength of Threaded Micropile Connections*" by Steven R. Musselman, J.H. Long, N. Carroll, and S. Farr)

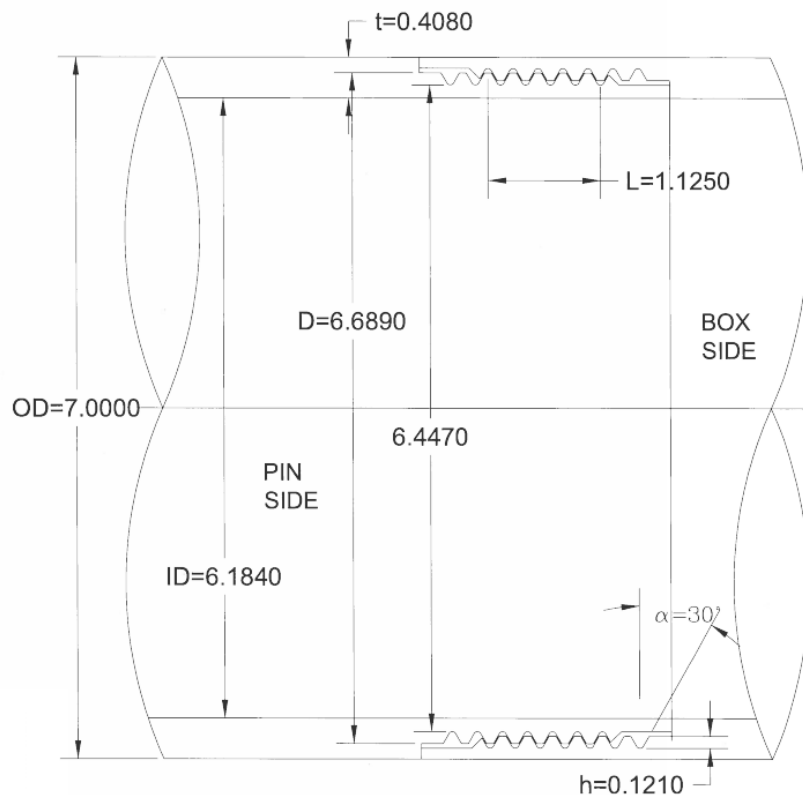

SOLUTION:

DETERMINE MATERIAL PROPERTIES AND JOINT GEOMETRY:



$$F_y = 80 \text{ ksi}$$

$$F_u = 100 \text{ ksi}$$

$$ID = 6.184 \text{ in}$$

$$OD = 7 \text{ in}$$

$$l = 1.125 \text{ in}$$

$$h = 0.121 \text{ in}$$

$$D = 6.689 \text{ in}$$

$$\alpha = 30^\circ$$

“JUMP OUT” EQUATION PARAMETERS TESTED/PROPOSED BY CLINEDINST PER REFERENCE:

$$a = 2.39$$

$$b = 0.59$$

$$\psi = 14.35 \text{ deg}$$

$$\Delta_e = 0$$

$$D_{tension} = D - 2h = 6.447 \text{ in}$$

CRITICAL AREA OF THE PIN CALCULATED USING EQN. (2) IN REFERENCE:

$$A_p = \frac{\pi[(D-h)^2 - ID^2]}{4} = 3.846 \text{ in}^2$$

“JUMP OUT” CAPACITY OF API ROUND THREAD CONNECTIONS IN TENSION USING EQN. (1) IN REFERENCE:

$$P_i = \left\{ \frac{a(2h/D - \Delta_e)^b (F_u)}{1 + D/2L[\tan(a - \psi)]} + \frac{F_y}{1 + D/2L[\tan(a - \psi)]} \right\} = \underline{\underline{265.165 \text{ kip}}}$$

“FRACTURE” CAPACITY OF THE PIN USING EQN. (3) IN REFERENCE:

$$P_{fracture} = F_u \frac{\pi[(D-2h)^2 - ID^2]}{4} = \underline{\underline{260.906 \text{ kip}}}$$

THE FAILURE MODE IS “FRACTURE” SINCE $P_{fracture} < P_i$.

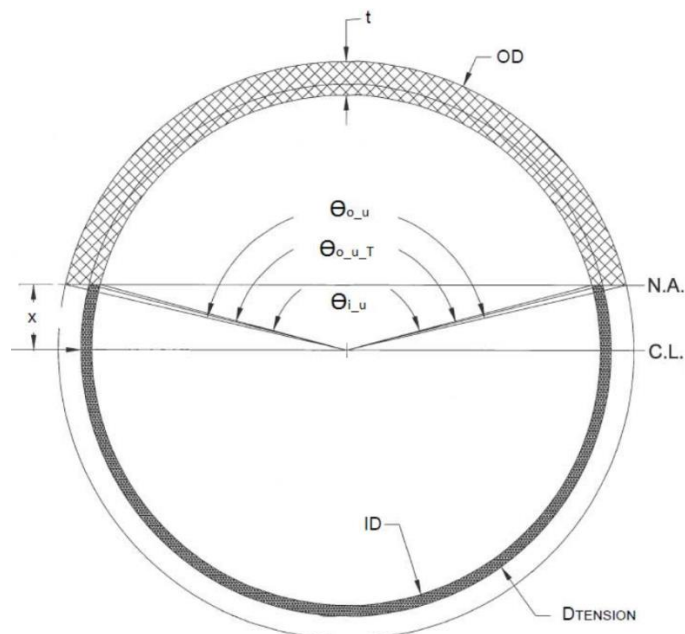



BASED ON THE RECOMMENDATIONS OF THE REFERENCE PAPER, THE BENDING CAPACITY OF THE CASING WILL BE DETERMINED USING THE PLASTIC TENSION-LINEAR COMPRESSION MODEL. BEFORE THE BENDING CAPACITY CAN BE DETERMINED, THE LOCATION OF THE NEUTRAL AXIS MUST BE FOUND. THE NEUTRAL AXIS CAN BE FOUND BY TRIAL AND ERROR METHOD.

ASSUME AN “x” VALUE:

$$x = 0.79 \text{ in}$$

$$\theta_{o_u} = 180^\circ - 2 \left[\text{asin} \left(\frac{x}{OD/2} \right) \right] = 2.686 \text{ rad}$$

$$I_{xo_u} = \frac{(OD/2)^4}{8} \left\{ \theta_{o_u} - \sin(\theta_{o_u}) + 2[\sin(\theta_{o_u})] \left[\sin \left(\frac{\theta_{o_u}}{2} \right) \right]^2 \right\} = 57.797 \text{ in}^4$$

$$A_{o_u} = \frac{(OD/2)^2}{2} [\theta_{o_u} - \sin(\theta_{o_u})] = 13.76 \text{ in}^2$$

$$C_{yo_u} = \frac{4(OD/2)}{3} \left\{ \frac{[\sin(\theta_{o_u}/2)]^3}{\theta_{o_u} - \sin(\theta_{o_u})} \right\} = 1.921 \text{ in}$$

$$I_{xco_u} = I_{xo_u} - A_{o_u}(C_{yo_u})^2 = 7.04 \text{ in}^4$$

$$I_{xo_u}' = I_{xco_u} + A_{o_u}(C_{yo_u} - x)^2 = 24.629 \text{ in}^4$$

$$\theta_{i_u} = 180^\circ - 2 \left[\text{asin} \left(\frac{x}{ID/2} \right) \right] = 2.625 \text{ rad}$$

$$I_{xi_u} = \frac{(ID/2)^4}{8} \left\{ \theta_{i_u} - \sin(\theta_{i_u}) + 2[\sin(\theta_{i_u})] \left[\sin \left(\frac{\theta_{i_u}}{2} \right) \right]^2 \right\} = 34.879 \text{ in}^4$$

$$A_{i_u} = \frac{(ID/2)^2}{2} [\theta_{i_u} - \sin(\theta_{i_u})] = 10.186 \text{ in}^2$$

$$C_{yi_u} = \frac{4(ID/2)}{3} \left\{ \frac{[\sin(\theta_{i_u}/2)]^3}{\theta_{i_u} - \sin(\theta_{i_u})} \right\} = 1.748 \text{ in}$$

$$I_{xci_u} = I_{xi_u} - A_{i_u}(C_{yi_u})^2 = 3.759 \text{ in}^4$$

$$I_{xi_u}' = I_{xci_u} + A_{i_u}(C_{yi_u} - x)^2 = 13.116 \text{ in}^4$$

$$I_{ABOVE} = I_{xo_u}' - I_{xi_u}' = \underline{\underline{11.514 \text{ in}^4}}$$

$$I_{tot_x}' = \frac{\pi}{64} (D_{tension}^4 - ID^4) + \frac{\pi}{4} (D_{tension}^2 - ID^2)(x^2) = 14.642 \text{ in}^4$$



$$\Theta_{o_u_T} = 180^\circ - 2 \left[\text{asin} \left(\frac{x}{D_{tension/2}} \right) \right] = 2.646 \text{ rad}$$

$$I_{xo_u_T} = \frac{(D_{tension/2})^4}{8} \left\{ \Theta_{o_u_T} - \sin(\Theta_{o_u_T}) + 2[\sin(\Theta_{o_u_T})] \left[\sin \left(\Theta_{o_u_T}/2 \right) \right]^2 \right\} = 41.36 \text{ in}^4$$

$$A_{o_u_T} = \frac{(D_{tension/2})^2}{2} [\Theta_{o_u_T} - \sin(\Theta_{o_u_T})] = 11.28 \text{ in}^2$$

$$C_{yo_u_T} = \frac{4(D_{tension/2})}{3} \left\{ \frac{[\sin(\Theta_{o_u_T}/2)]^3}{\Theta_{o_u_T} - \sin(\Theta_{o_u_T})} \right\} = 1.804 \text{ in}$$

$$I_{xco_u_T} = I_{xo_u_T} - A_{o_u_T}(C_{yo_u_T})^2 = 4.653 \text{ in}^4$$

$$I_{xo_u_T}' = I_{xco_u_T} + A_{o_u_T}(C_{yo_u_T} - x)^2 = 16.249 \text{ in}^4$$

$$\Theta_{i_u_T} = 180^\circ - 2 \left[\text{asin} \left(\frac{x}{ID/2} \right) \right] = 2.625 \text{ rad}$$

$$I_{xi_u_T} = \frac{(ID/2)^4}{8} \left\{ \Theta_{i_u_T} - \sin(\Theta_{i_u_T}) + 2[\sin(\Theta_{i_u_T})] \left[\sin \left(\Theta_{i_u_T}/2 \right) \right]^2 \right\} = 34.897 \text{ in}^4$$

$$A_{i_u_T} = \frac{(ID/2)^2}{2} [\Theta_{i_u_T} - \sin(\Theta_{i_u_T})] = 10.186 \text{ in}^2$$

$$C_{yi_u_T} = \frac{4(ID/2)}{3} \left\{ \frac{[\sin(\Theta_{i_u_T}/2)]^3}{\Theta_{i_u_T} - \sin(\Theta_{i_u_T})} \right\} = 1.748 \text{ in}$$

$$I_{xci_u_T} = I_{xi_u_T} - A_{i_u_T}(C_{yi_u_T})^2 = 3.759 \text{ in}^4$$

$$I_{xi_u_T}' = I_{xci_u_T} + A_{i_u_T}(C_{yi_u_T} - x)^2 = 13.116 \text{ in}^4$$

$$I_{ABOVE_T} = I_{xo_u_T}' - I_{xo_u_T}' = 3.133 \text{ in}^4$$

$$I_{BELOW} = I_{tot_x}' - I_{ABOVE_T} = \underline{\underline{11.508 \text{ in}^4}}$$

SINCE $I_{ABOVE} = 11.514 \text{ in}^4 \approx I_{BELOW} = 11.508 \text{ in}^4$, PROCEED WITH $x = 0.79 \text{ in}$.

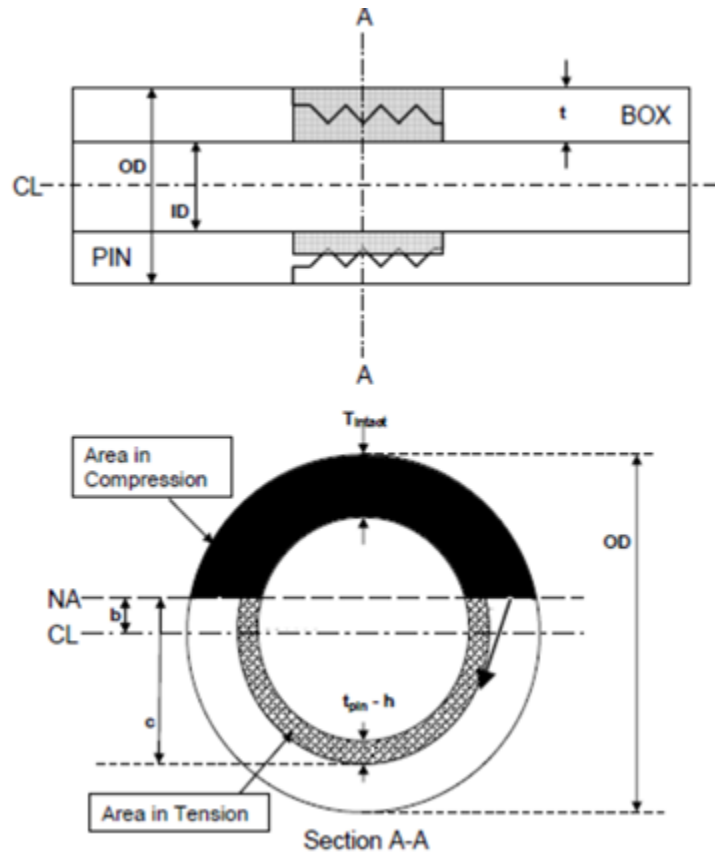

$$I_{REDUCED} = I_{BELOW} + I_{ABOVE} = 23.022 \text{ in}^4$$

$$I_{FULL} = \frac{\pi}{64} (OD^4 - ID^4) = 46.071 \text{ in}^4$$

$$\text{Stiffness Ratio} = I_{REDUCED} / I_{FULL} = 0.5$$

DETERMINE BENDING CAPACITY BASED ON THE PLASTIC TENSION-LINEAR COMPRESSION MODEL:

$$f_{LIM} = \frac{P_{fracture}}{\pi[(D-2h)^2 - ID^2]/4} = 100 \text{ ksi}$$

$$A_{TENSION} = \frac{\pi}{4} (D_{tension}^2 - ID^2) \left[\frac{360^\circ - (\theta_{o,u,T} + \theta_{i,u,T}/2)}{360^\circ} \right] = 1.515 \text{ in}^2$$

$$P_T = f_{LIM} (A_{TENSION}) = 151.462 \text{ kip}$$

$$M_T = P_T (C_{y_{o,u,T}}) = 273.226 \text{ kip} \cdot \text{in}$$

$$P_T = P_C$$



$$M_C = P_C(C_{y_{o_u}}) = 290.903 \text{ kip} \cdot \text{in}$$

BENDING CAPACITY AT THE THREADED JOINT IS CALCULATED AS:

$$M_{TOT} = M_T + M_C = \underline{\underline{564.129 \text{ kip} \cdot \text{in}}}$$

$$M_{FULL} = \frac{F_y(I_{full})}{OD/2} = 1,053.062 \text{ kip} \cdot \text{in}$$

$$\text{Bending Capacity Ratio} = \left(M_{TOT} / M_{FULL} \right) 100\% = \underline{\underline{53.6\%}}$$



EXAMPLE 5.1 – DEVELOP AN ACTIVE SOIL PRESSURE DIAGRAM

PROBLEM:

DEVELOP ACTIVE SOIL PRESSURES FOR THE FOLLOWING SOIL PROFILE.

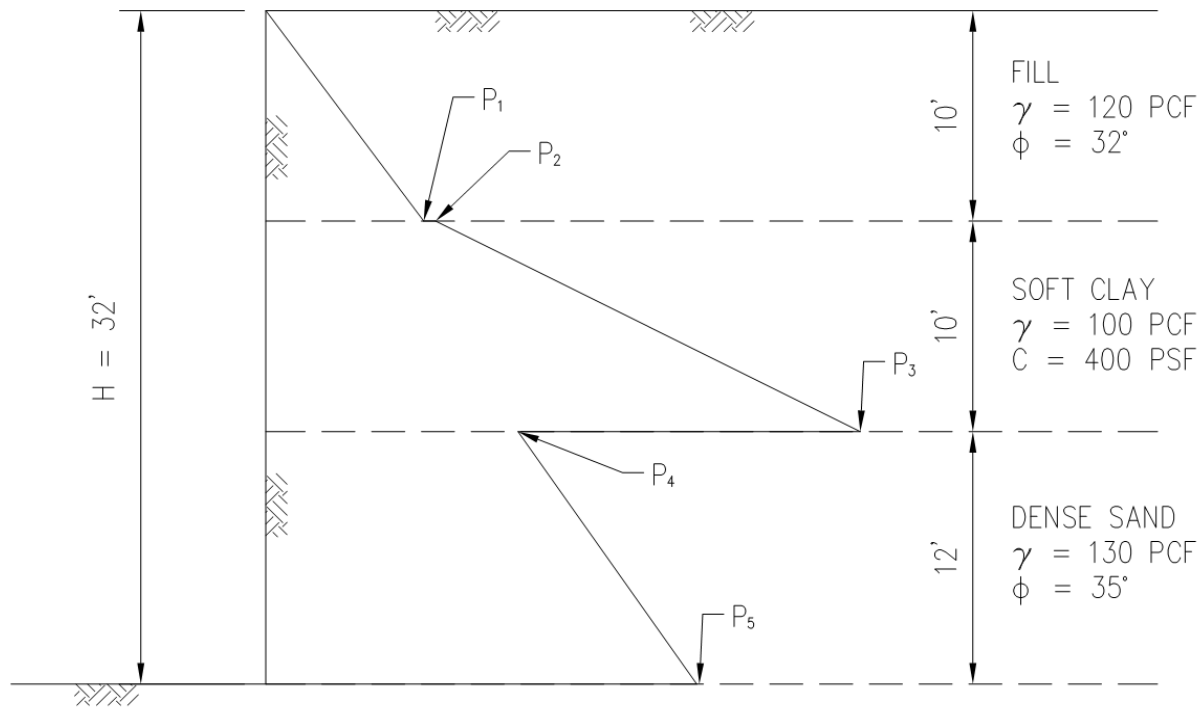

SOLUTION:

USING RANKINE'S THEORY –

$$K_{A,FILL} = \tan^2(45^\circ - \phi_{FILL}/2) = \tan^2(45^\circ - 32^\circ/2) = \underline{\underline{0.31}}$$

$$K_{A,DENSE\ SAND} = \tan^2(45^\circ - \phi_{DENSE\ SAND}/2) = \tan^2(45^\circ - 35^\circ/2) = \underline{\underline{0.27}}$$

COMPUTE ACTIVE PRESSURES –

$$P_1 = K_{A,FILL}(\gamma_{FILL})(10') = 0.31(120)(10) = \underline{\underline{372PSF}} > 30(10) = 300PSF$$

$$P_2 = \gamma_{FILL}(10') - 2C = 120(10) - 2(400) = \underline{\underline{400PSF}}$$

$$P_3 = P_2 + \gamma_{SOFT\ CLAY}(10') = 400 + 100(10) = \underline{\underline{1,400PSF}} > 30(20) = 600PSF$$

$$P_4 = K_{A,DENSE\ SAND}[(\gamma_{FILL})(10') + (\gamma_{SOFT\ CLAY})(10')] = 0.27[(120)(10) + (100)(10)]$$



$$= 594PSF < 30(20) = \underline{\underline{600PSF}}$$

$$P_5 = P_4 + K_{A,DENSE\ SAND}[(\gamma_{DENSE\ SAND})(12')] = 594 + 0.27(130)(12)$$

$$= \underline{\underline{1,015PSF}} > 30(32) = 960PSF$$

Note: Refer to [Section 5.2.2](#) for the minimum active pressure requirement (the active pressure at any depth shall not be less than 30(Y) psf where Y is a depth below the ground surface in feet) and its [commentary](#)⁹.



EXAMPLE 5.2 – DEVELOP AN APPARENT SOIL PRESSURE DIAGRAM

PROBLEM:

DEVELOP AN APPARENT PRESSURE DIAGRAM FOR THE SOIL PROFILE GIVEN IN EXPAMPLE 5.1.

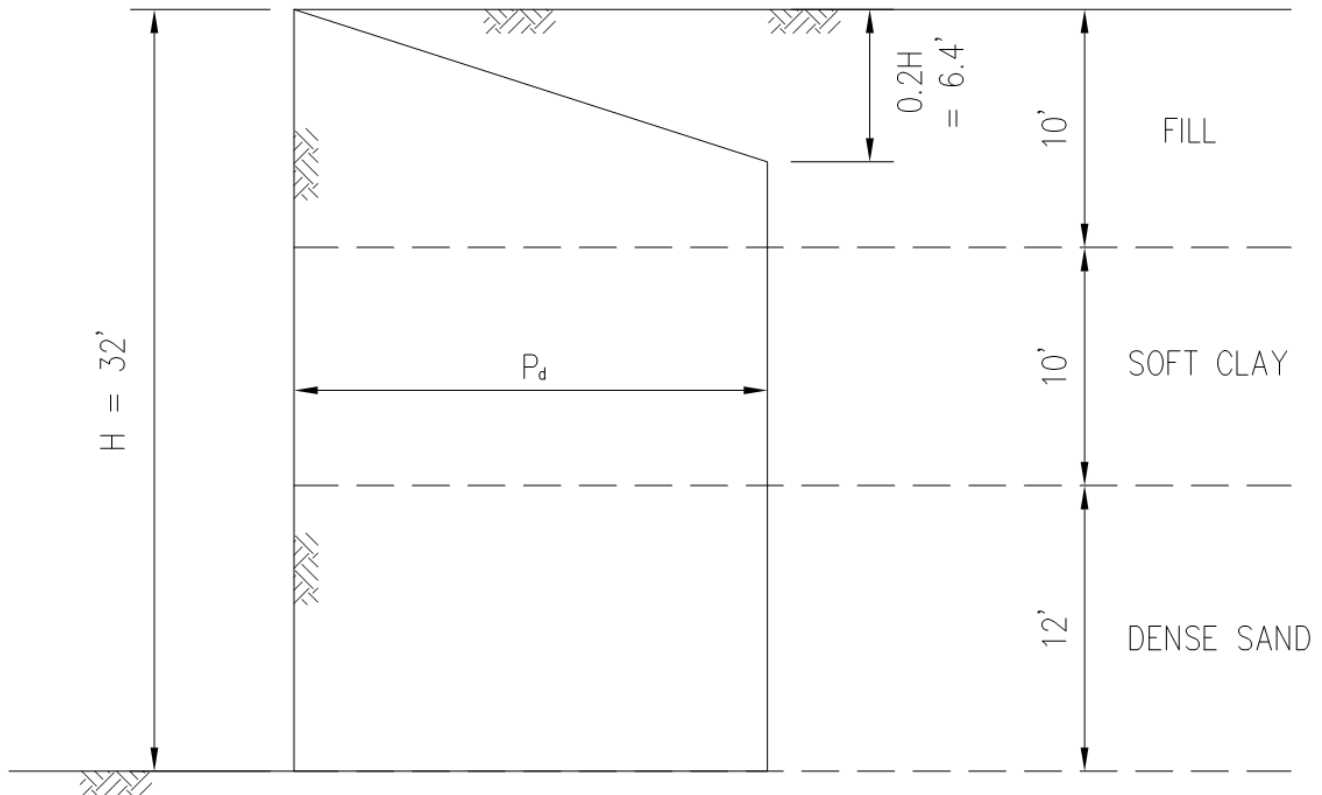

SOLUTION:

COMPUTE TOTAL ACTIVE PRESSURE RESULTANT (A_1) –

$$A_1 = (372)(10)/2 + (400 + 1400)(10)/2 + (594 + 1015)(12)/2 = \underline{\underline{20,514\text{LBS/FT}}}$$

COMPUTE P_d –

$$P_d = 1.4A_1/0.9H = 1.4(20,514)/0.9(32) = \underline{\underline{997\text{PSF}}}$$



EXAMPLE 5.3 – DETERMINE PASSIVE RESISTANCE (COHESIONLESS SOIL)

PROBLEM:

DETERMINE THE PASSIVE RESISTANCE ACTING ON THE BOTTOM OF A STEEL SHEET PILE WALL EMBEDDED IN MEDIUM DENSE CLEAN SAND WITH THE FOLLOWING PROPERTIES WITH:

1. RANKINE'S THEORY
2. LOGARITHMIC SPIRAL THEORY

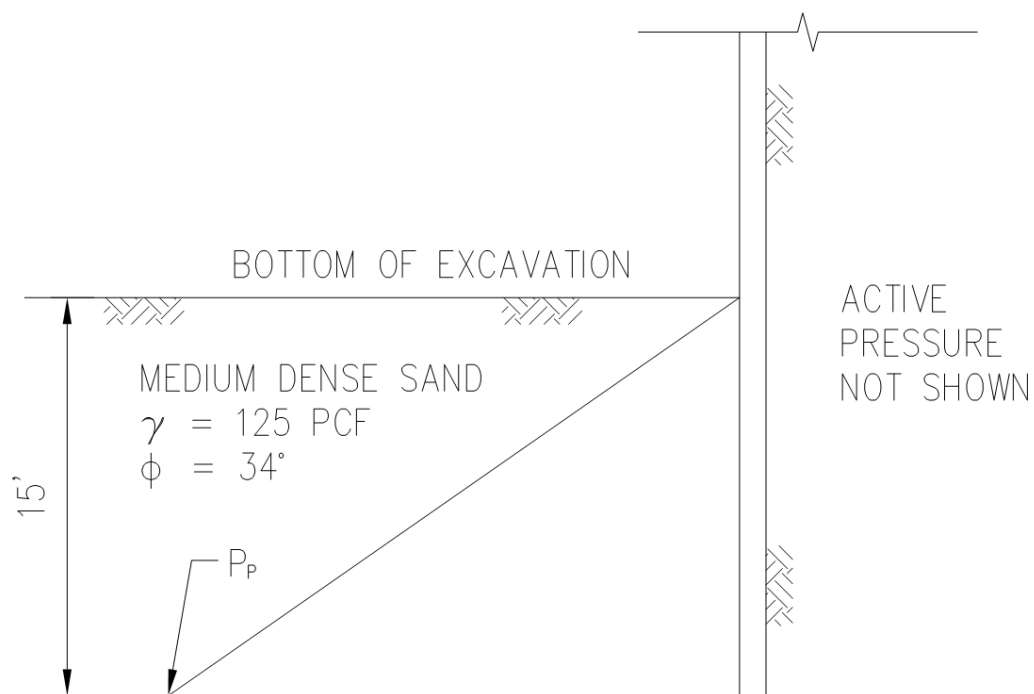

SOLUTION:

1. USING RANKINE'S THEORY –

$$K_{P,RANKINE} = \tan^2(45^\circ + \phi/2) = \tan^2(45^\circ + 34^\circ/2) = \underline{\underline{3.54}}$$

$$P_{P,RANKIN} = K_{P,RANKINE}(\gamma)(15') = 3.54(125)(15) = \underline{\underline{6,637.5PSF}}$$

2. USING LOGARITHMIC SPIRAL THEORY



Interface Materials	Friction Angle, δ (degrees)	Coefficient of Friction, $\tan \delta$ (dim.)
Mass concrete on the following foundation materials: <ul style="list-style-type: none"> Clean sound rock Clean gravel, gravel-sand mixtures, coarse sand Clean fine to medium sand, silty medium to coarse sand, silty or clayey gravel Clean fine sand, silty or clayey fine to medium sand Fine sandy silt, nonplastic silt Very stiff and hard residual or preconsolidated clay Medium stiff and stiff clay and silty clay 	35 29 to 31 24 to 29 19 to 24 17 to 19 22 to 26 17 to 19	0.70 0.55 to 0.60 0.45 to 0.55 0.34 to 0.45 0.31 to 0.34 0.40 to 0.49 0.31 to 0.34
Masonry on foundation materials has same friction factors.		
Steel sheet piles against the following soils: <ul style="list-style-type: none"> Clean gravel, gravel-sand mixtures, well-graded rock fill with spalls Clean sand, silty sand-gravel mixture, single-size hard rock fill Silty sand, gravel or sand mixed with silt or clay Fine sandy silt, nonplastic silt 	22 17 14 11	0.40 0.31 0.25 0.19
Formed or precast concrete or concrete sheet piling against the following soils: <ul style="list-style-type: none"> Clean gravel, gravel-sand mixture, well-graded rock fill with spalls Clean sand, silty sand-gravel mixture, single-size hard rock fill Silty sand, gravel or sand mixed with silt or clay Fine sandy silt, nonplastic silt 	22 to 26 17 to 22 17 14	0.40 to 0.49 0.31 to 0.40 0.31 0.25
Various structural materials: <ul style="list-style-type: none"> Masonry on masonry, igneous and metamorphic rocks: <ul style="list-style-type: none"> dressed soft rock on dressed soft rock dressed hard rock on dressed soft rock dressed hard rock on dressed hard rock Masonry on wood in direction of cross grain Steel on steel at sheet pile interlocks 	35 33 29 26 17	0.70 0.65 0.55 0.49 0.31

**TABLE 3.11.5.3-1 – FRICTION ANGLE FOR DISSIMILAR MATERIALS
 AASHTO LRFD 7TH EDITION, 2014**

DETERMINE THE DESIGN WALL INTERFACE FRICTION ANGLE δ_{DESIGN} –

$$\delta_{ULTIMATE} = 17^{\circ}$$

FOR STEEL SHEET PILES AGAINST CLEAN SAND SHOWN IN TABLE ABOVE

$$\delta_{DESIGN} = \delta_{ULTIMATE} / 2 = 8.5^{\circ} \leq \phi / 4 = 34^{\circ} / 4 = 8.5^{\circ}$$



USE THE DIAGRAM IN THE NEXT PAGE TO COMPUTE K_P –

$$K_{P,\delta/\phi=-1.0} = 9.5 \text{ (FOR } \phi = 34^\circ \text{ \& } \beta / \phi = 0)$$

$$-\delta/\phi = -8.5^\circ/34^\circ = -0.25$$

REDUCTION FACTOR (R) \approx 0.52 (LINEAR INTERPOLATION IS ACCEPTED)

$$K_P = R(K_{P,\delta/\phi=-1.0}) = 0.52(9.5) = \underline{\underline{4.9}}$$

COMPUTE P_P –

$$P_P = K_P(\gamma)(15') = 4.9(125)(15) = \underline{\underline{9,188PSF}}$$

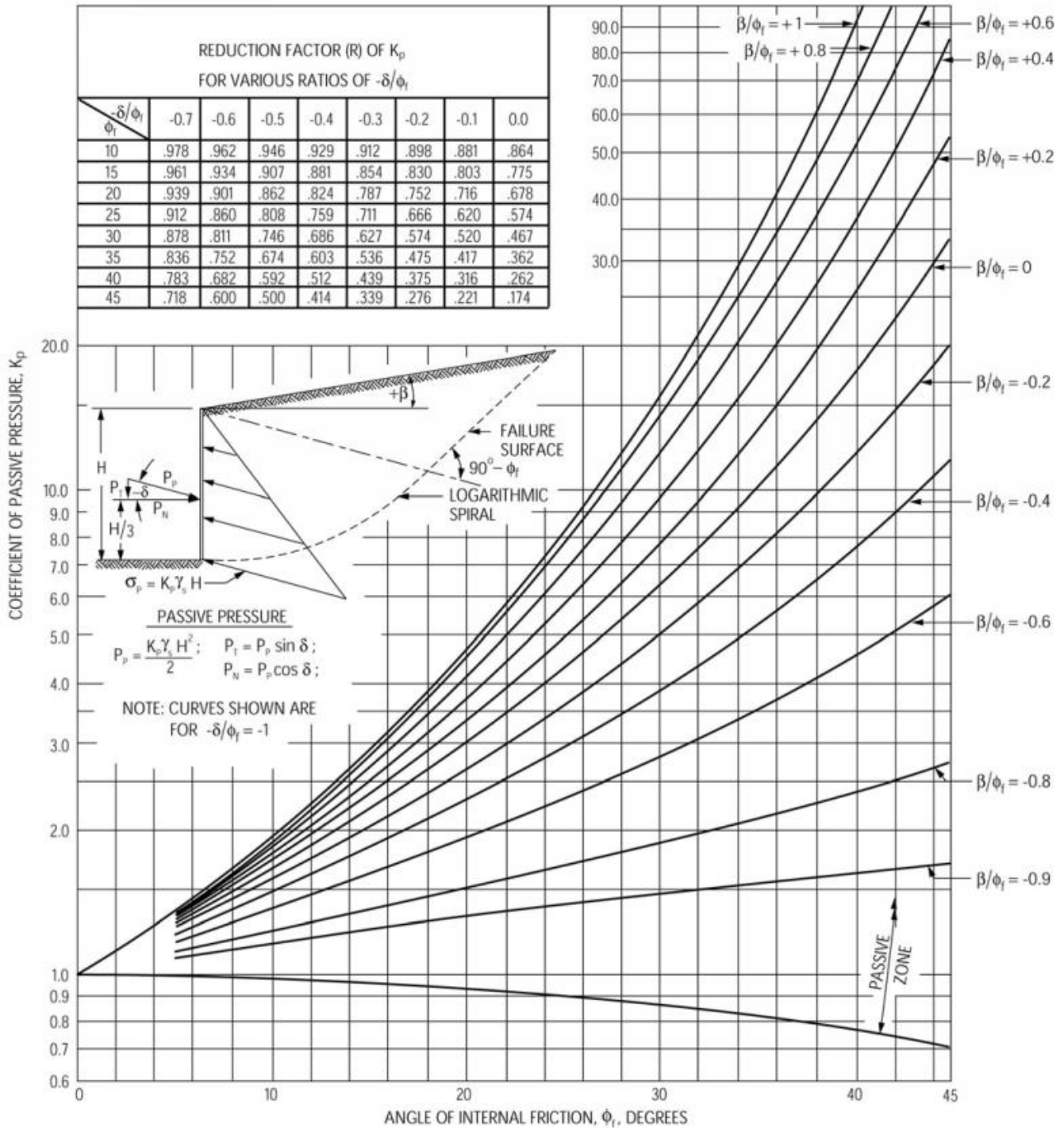

PASSIVE EARTH PRESSURE COEFFICIENT (Caquot and Kerisel, 1948)



EXAMPLE 5.4 – DETERMINE PASSIVE RESISTANCE (COHESIVE SOIL)

PROBLEM:

DETERMINE THE PASSIVE RESISTANCE ACTING ON THE BOTTOM OF SHORING WALL EMBEDDED IN MEDIUM CLAY WITH THE FOLLOWING PROPERTIES:

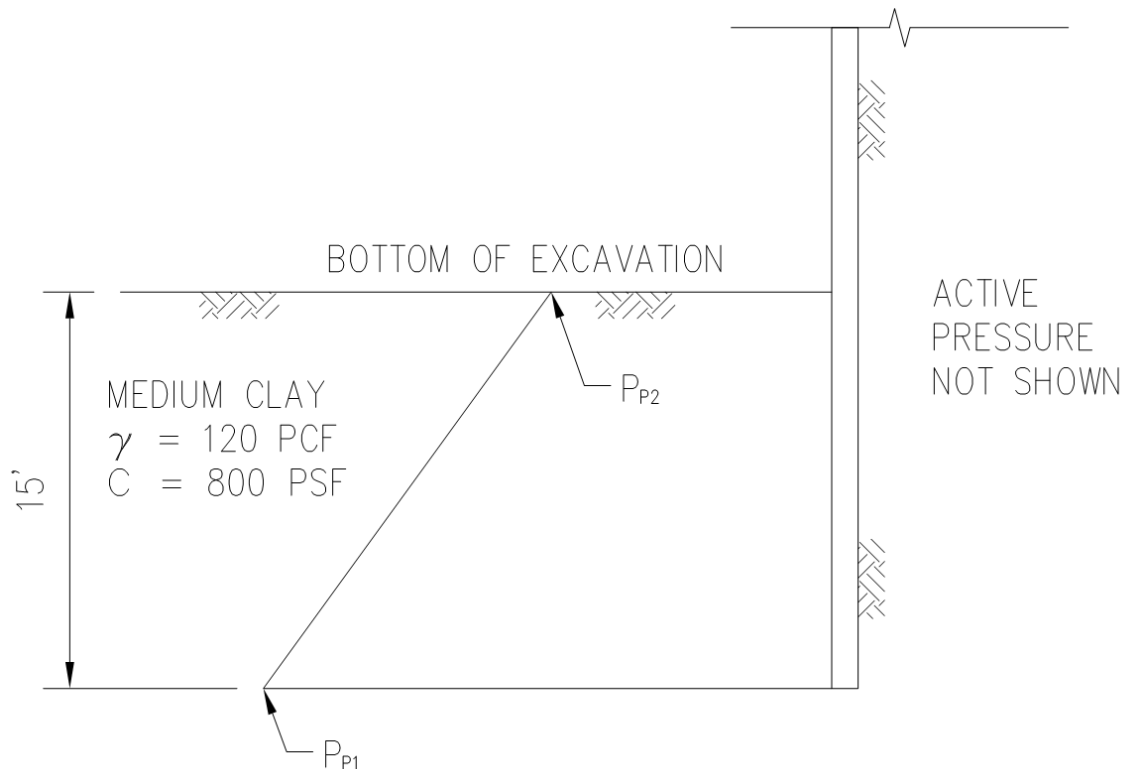

SOLUTION:

COMPUTE P_{P1} & P_{P2} –

$$P_{P1} = 2C = 2(800) = \underline{\underline{1,600PSF}}$$

$$P_{P2} = P_{P1} + \gamma(15') = 1600 + 120(15) = \underline{\underline{3,400PSF}}$$



EXAMPLE 6.1 – RAPID TRANSIT LIVE LOAD SURCHARGE FROM TWO TRACKS

PROBLEM:

COMPUTE THE LATERAL SURCHARGE PRESSURES ACTING ON THE SHORING WALL BASED ON THE FOLLOWING TRACK GEOMETRY. CTA RAILBOUND CRANE TRAIN MAY OPERATE ON TRACK 2.

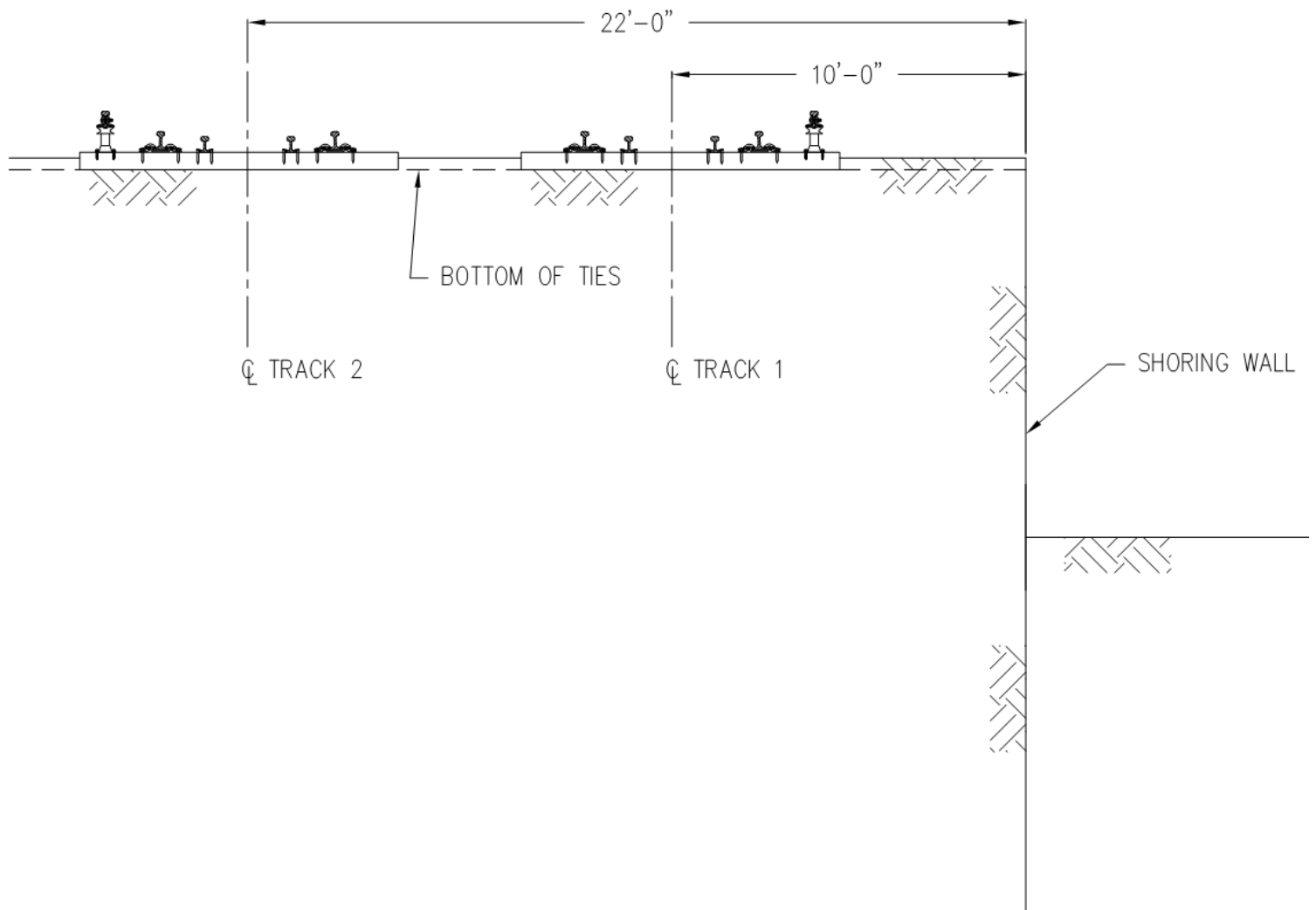

SOLUTION: (SEE NEXT PAGE)



Analysis Parameters

	Tie Length:	9 ft		
Distance from face of shoring wall to centerline of track 1:	10 ft	Strip Load:	491 psf	606 psf for crane train
Distance from face of shoring wall to centerline of track 2:	22 ft	Strip Load:	606 psf	491 psf for normal service
Distance from face of shoring wall to centerline of track 3:	0 ft	Strip Load:	0 psf	50% Reduction Included
Distance from face of shoring wall to centerline of track 4:	0 ft	Strip Load:	0 psf	25% Reduction Included

Lateral Pressures Per AREMA Manual for Railway Engineering Chapter 8 Article 20.3.2.2 & Section 5.1

Depth d (ft)	Track 1 P _{s,1} (psf)	Track 2 P _{s,2} (psf)	Track 3 P _{s,3} (psf)	Track 4 P _{s,4} (psf)	Total P _{s,total} (psf)
0	0	0	0	0	0
1	69	15	0	0	84
2	127	29	0	0	156
3	168	43	0	0	212
4	192	56	0	0	248
5	201	67	0	0	268
6	199	77	0	0	276
7	189	86	0	0	275
8	176	92	0	0	268
9	161	97	0	0	258
10	145	101	0	0	246
11	130	103	0	0	234
12	116	104	0	0	221
13	103	104	0	0	208
14	92	104	0	0	195
15	82	102	0	0	184
16	73	100	0	0	172
17	65	97	0	0	162
18	58	94	0	0	151
19	52	90	0	0	142
20	46	87	0	0	133
21	42	83	0	0	125
22	37	79	0	0	117
23	34	76	0	0	110
24	31	72	0	0	103
25	28	69	0	0	96
26	25	65	0	0	91
27	23	62	0	0	85
28	21	59	0	0	80
29	19	56	0	0	75
30	18	53	0	0	71
31	16	50	0	0	66
32	15	48	0	0	62
33	14	45	0	0	59
34	13	43	0	0	55
35	12	40	0	0	52
36	11	38	0	0	49
37	10	36	0	0	47
38	9	35	0	0	44
39	9	33	0	0	42
40	8	31	0	0	39
41	8	30	0	0	37
42	7	28	0	0	35
43	7	27	0	0	33
44	6	25	0	0	32
45	6	24	0	0	30
46	6	23	0	0	29
47	5	22	0	0	27
48	5	21	0	0	26
49	5	20	0	0	25
50	4	19	0	0	23

d = depth below bottom of tie
P_{s,1} = lateral surcharge from track 1
P_{s,2} = lateral surcharge from track 2
P_{s,3} = lateral surcharge from track 3
P_{s,4} = lateral surcharge from track 4
P_{s,total} = combined lateral surcharge ΣP_{s,n}
P_{s,total,max} = 276 PSF
For "Simplified" Surcharge
P_{s,sample} = 220.8 PSF

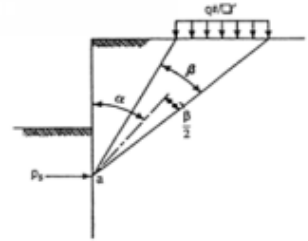

$$P_s = \frac{2q}{\pi} (\beta + \sin\beta \sin^2\alpha - \sin\beta \cos^2\alpha)$$

Note: α & β are in radians

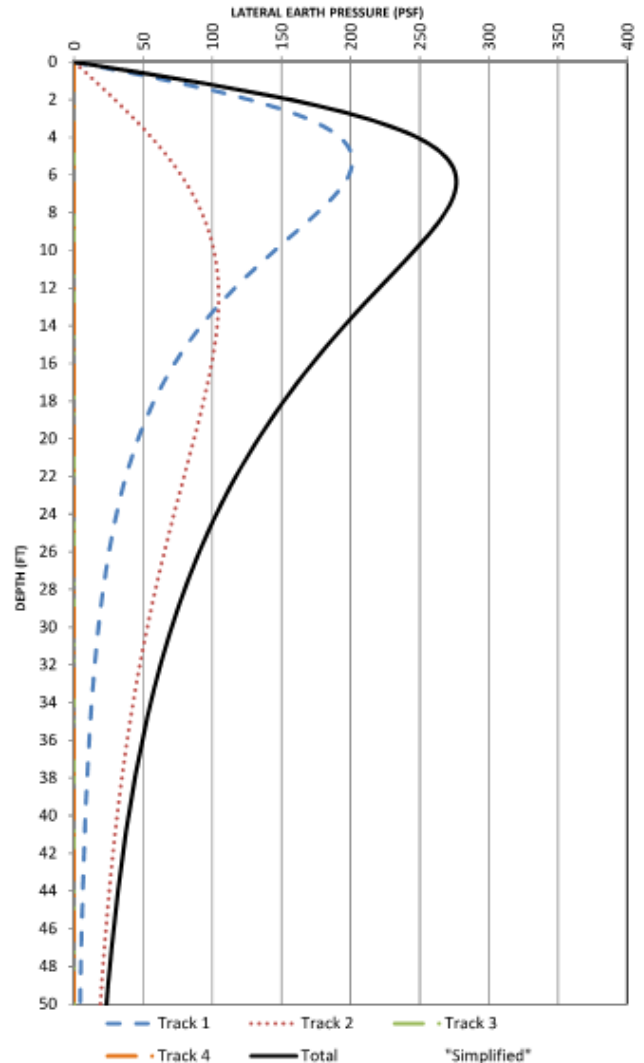



EXAMPLE 6.2 – RAPID TRANSIT LIVE LOAD SURCHARGE FROM THREE TRACKS

PROBLEM:

COMPUTE THE LATERAL SURCHARGE PRESSURES ACTING ON THE SHORING WALL BASED ON THE FOLLOWING TRACK GEOMETRY. CTA RAILBOUND CRANE TRAIN MAY OPERATE ON TRACK 3.

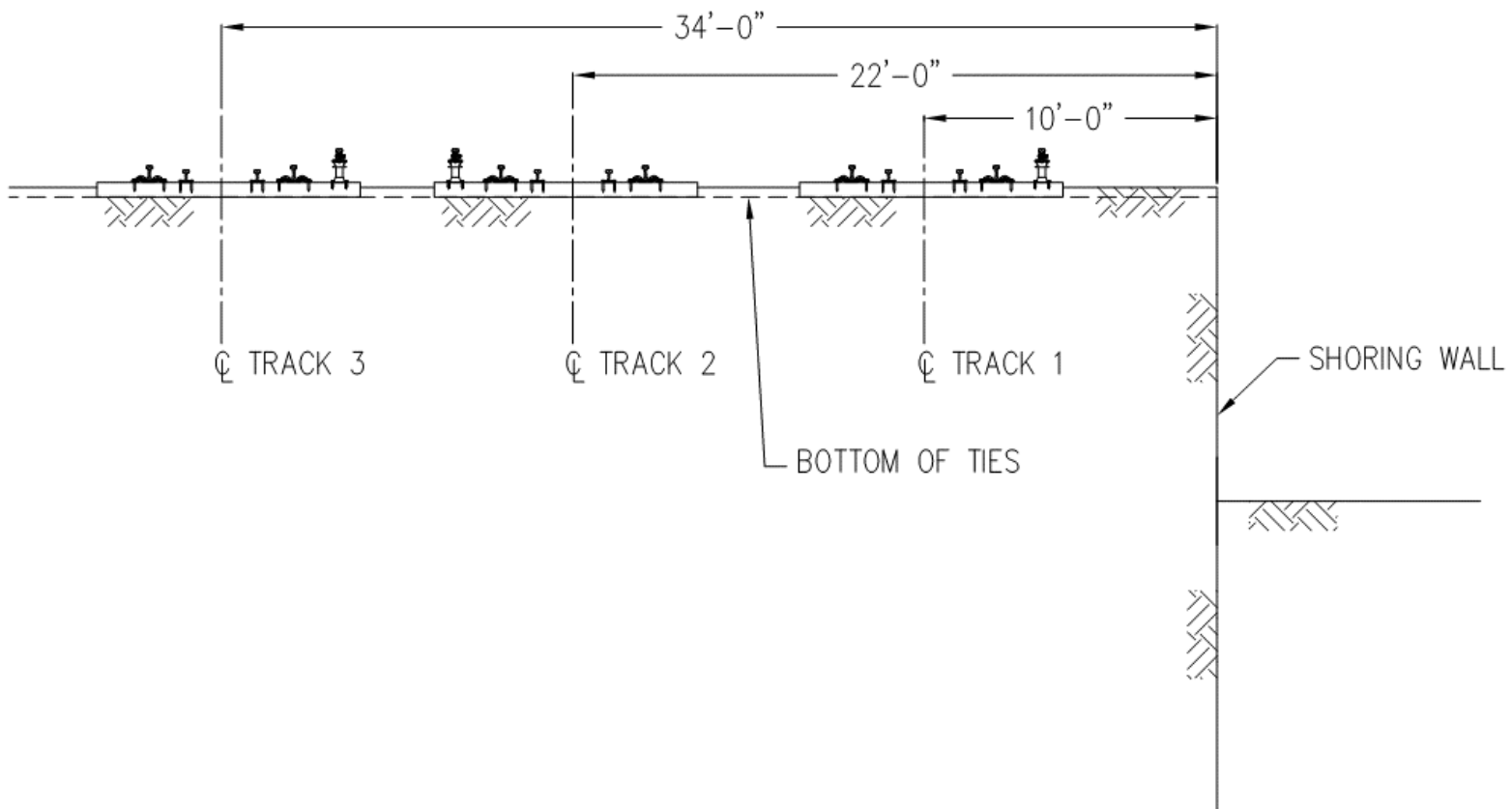

SOLUTION: (SEE NEXT PAGE)



Analysis Parameters

Tie Length:	9 ft	Strip Load:	491 psf	606 psf for crane train
Distance from face of shoring wall to centerline of track 1:	10 ft	Strip Load:	491 psf	491 psf for normal service
Distance from face of shoring wall to centerline of track 2:	22 ft	Strip Load:	606 psf	50% Reduction Included
Distance from face of shoring wall to centerline of track 3:	34 ft	Strip Load:	0 psf	25% Reduction Included
Distance from face of shoring wall to centerline of track 4:	0 ft	Strip Load:	0 psf	

Lateral Pressures Per AREMA Manual for Railway Engineering Chapter 8 Article 20.3.2.2 & Section 5.1

Depth d (ft)	Track 1 P _{s,1} (psf)	Track 2 P _{s,2} (psf)	Track 3 P _{s,3} (psf)	Track 4 P _{s,4} (psf)	Total P _{s,total} (psf)
0	0	0	0	0	0
1	69	12	3	0	84
2	127	24	6	0	157
3	168	35	9	0	212
4	192	45	12	0	249
5	201	55	15	0	270
6	199	63	17	0	279
7	189	69	20	0	278
8	176	75	22	0	273
9	161	79	24	0	264
10	145	82	26	0	253
11	130	84	27	0	241
12	116	85	29	0	230
13	103	85	30	0	218
14	92	84	31	0	207
15	82	83	32	0	196
16	73	81	33	0	186
17	65	78	33	0	176
18	58	76	33	0	167
19	52	73	33	0	158
20	46	70	33	0	150
21	42	67	33	0	142
22	37	64	33	0	135
23	34	61	33	0	128
24	31	59	32	0	121
25	28	56	32	0	115
26	25	53	31	0	109
27	23	50	31	0	104
28	21	48	30	0	99
29	19	45	29	0	94
30	18	43	29	0	89
31	16	41	28	0	85
32	15	39	27	0	81
33	14	37	26	0	77
34	13	35	26	0	73
35	12	33	25	0	69
36	11	31	24	0	66
37	10	30	23	0	63
38	9	28	23	0	60
39	9	27	22	0	57
40	8	25	21	0	55
41	8	24	21	0	52
42	7	23	20	0	50
43	7	22	19	0	48
44	6	21	19	0	45
45	6	20	18	0	43
46	6	19	17	0	42
47	5	18	17	0	40
48	5	17	16	0	38
49	5	16	16	0	36
50	4	15	15	0	35

d = depth below bottom of tie
P_{s,1} = lateral surcharge from track 1
P_{s,2} = lateral surcharge from track 2
P_{s,3} = lateral surcharge from track 3
P_{s,4} = lateral surcharge from track 4
P_{s,total} = combined lateral surcharge ΣP_{s,n}
P_{s,total,max} = 279 PSF
For "Simplified" Surcharge
P_{s,simple} = 222.9 PSF

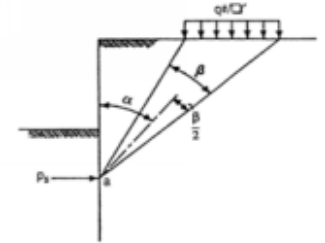

$$p_s = \frac{2q}{\pi} (\beta + \sin\beta \sin^2\alpha - \sin\beta \cos^2\alpha)$$

Note: α & β are in radians

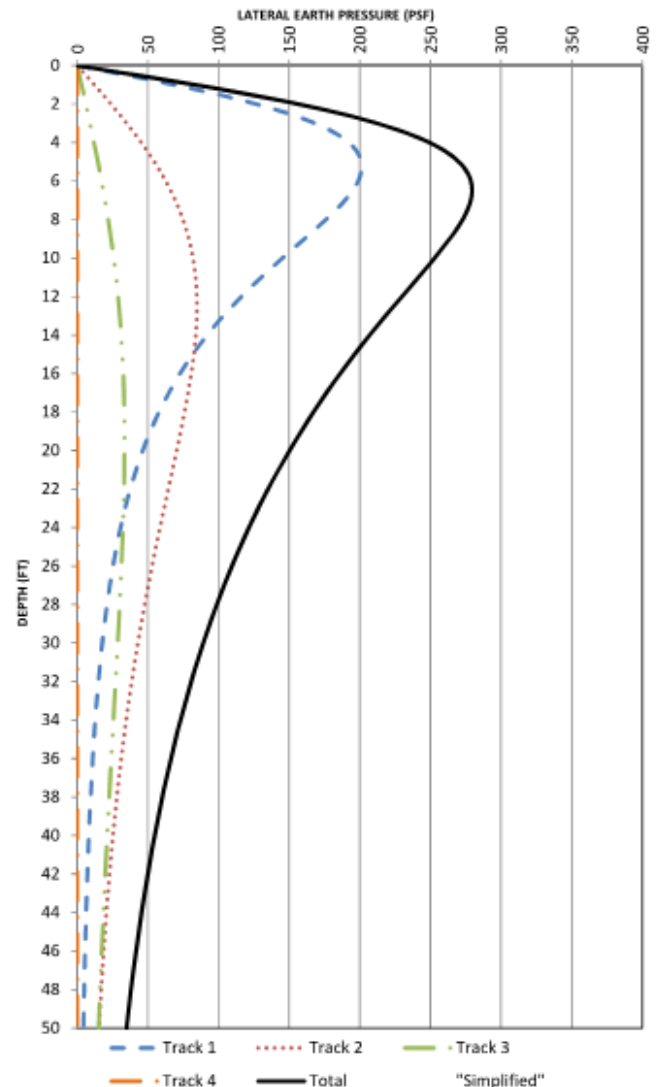



EXAMPLE 6.3 – “SIMPLIFIED” RAPID TRANSIT LIVE LOAD SURCHARGE

PROBLEM:

COMPUTE THE “SIMPLIFIED” LATERAL SURCHARGE PRESSURES ACTING ON THE SHORING WALL BASED ON THE TRACK GEOMETRY IN EXAMPLE 6.3 WITH AN ADDITIONAL TRACK 4 AT 46'-0" FROM FACE OF THE SHORING WALL. CTA RAILBOUND CRANE TRAIN MAY OPERATE ON TRACK 4.

SOLUTION: (SEE NEXT PAGE)



Analysis Parameters

	Tie Length:	9 ft		
Distance from face of shoring wall to centerline of track 1:	10 ft	Strip Load:	491 psf	606 psf for crane train
Distance from face of shoring wall to centerline of track 2:	22 ft	Strip Load:	491 psf	491 psf for normal service
Distance from face of shoring wall to centerline of track 3:	34 ft	Strip Load:	491 psf	50% Reduction Included
Distance from face of shoring wall to centerline of track 4:	46 ft	Strip Load:	606 psf	25% Reduction Included

Lateral Pressures Per AREMA Manual for Railway Engineering Chapter 8 Article 20.3.2.2 & Section 5.1

Depth d (ft)	Track 1 P _{s,1} (psf)	Track 2 P _{s,2} (psf)	Track 3 P _{s,3} (psf)	Track 4 P _{s,4} (psf)	Total P _{s,total} (psf)
0	0	0	0	0	0
1	69	12	2	1	84
2	127	24	5	2	157
3	168	35	7	2	213
4	192	45	10	3	250
5	201	55	12	4	271
6	199	63	14	5	280
7	189	69	16	6	280
8	176	75	18	6	275
9	161	79	19	7	266
10	145	82	21	8	256
11	130	84	22	8	244
12	116	85	23	9	233
13	103	85	24	9	222
14	92	84	25	10	211
15	82	83	26	10	200
16	73	81	26	11	190
17	65	78	27	11	181
18	58	76	27	11	172
19	52	73	27	11	163
20	46	70	27	12	155
21	42	67	27	12	148
22	37	64	27	12	141
23	34	61	27	12	134
24	31	59	26	12	128
25	28	56	26	12	122
26	25	53	25	12	116
27	23	50	25	12	110
28	21	48	24	12	105
29	19	45	24	12	100
30	18	43	23	12	96
31	16	41	23	12	91
32	15	39	22	12	87
33	14	37	21	12	83
34	13	35	21	12	80
35	12	33	20	12	76
36	11	31	20	11	73
37	10	30	19	11	70
38	9	28	18	11	67
39	9	27	18	11	64
40	8	25	17	11	61
41	8	24	17	10	59
42	7	23	16	10	56
43	7	22	16	10	54
44	6	21	15	10	52
45	6	20	14	10	50
46	6	19	14	9	48
47	5	18	14	9	46
48	5	17	13	9	44
49	5	16	13	9	42
50	4	15	12	9	41

d = depth below bottom of tie
P_{s,1} = lateral surcharge from track 1
P_{s,2} = lateral surcharge from track 2
P_{s,3} = lateral surcharge from track 3
P_{s,4} = lateral surcharge from track 4
P_{s,total} = combined lateral surcharge ΣP_{s,n}
P_{s,total,max} = 280 PSF
For "Simplified" Surcharge
P_{s,simple} = 224.2 PSF

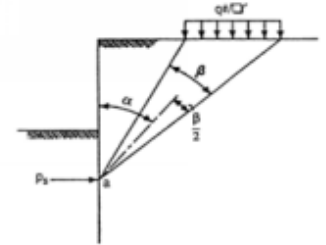

$$P_s = \frac{2q}{\pi} (\beta + \sin\beta \sin^2\alpha - \sin\beta \cos^2\alpha)$$

Note: α & β are in radians

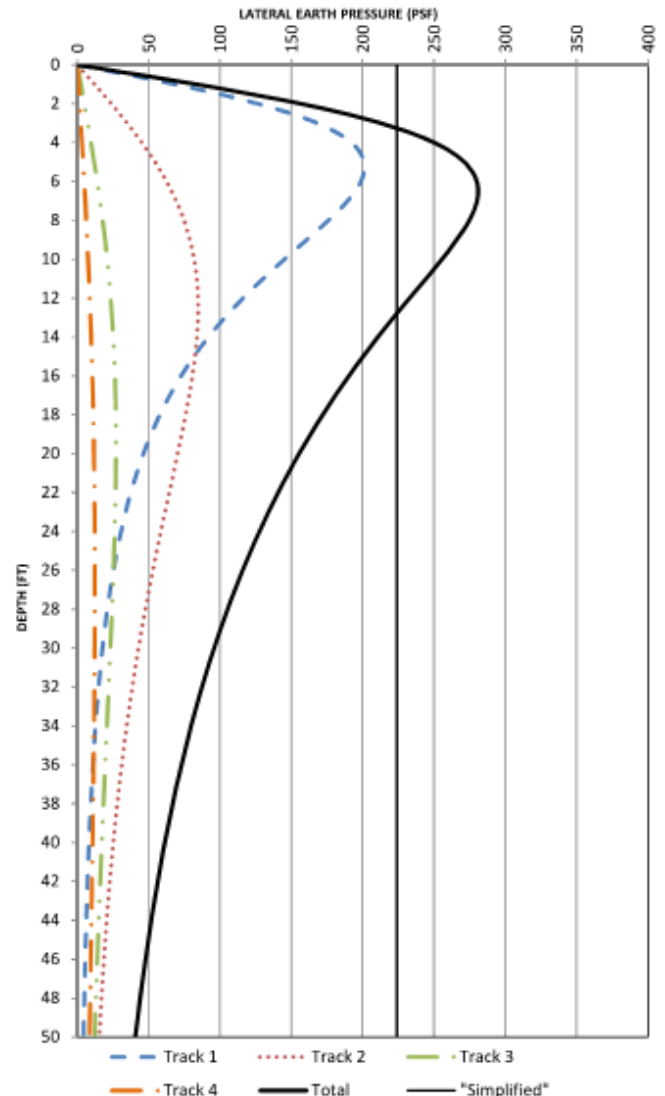



EXAMPLE 6.4 – CONSTRUCT THE ACTUAL RAPID TRANSIT SURCHARGE PRESSURE

PROBLEM:

PER SECTION 5.3, THERE ARE CASES WHERE “SIMPLIFIED” SURCHARGE PRESSURE DISTRIBUTION MAY NOT BE ALLOWED (REFER TO [SECTION 6.3](#)). CONSTRUCT THE ACTUAL TRANSIT SURCHARGE PRESSURE FOR A SHORING WALL 10'-0" FROM THE CENTERLINE OF TRACK. CTA RAILBOUND CRANE TRAIN MAY OPERATE ON THIS TRACK.

SOLUTION: (SEE NEXT PAGE)

Note: This example only illustrates how CTA Engineering would distribute the surcharge pressure. The actual Rapid Transit surcharge pressure is NOT required to be distributed as shown in this example. The Engineer in Responsible Charge shall evaluate how surcharge should be distributed for the shoring system design with engineering knowledge, experience, and judgment.



Analysis Parameters

	Tie Length:	9 ft			
Distance from face of shoring wall to centerline of track 1:	10 ft	Strip Load:	606 psf	606 psf for crane train	
Distance from face of shoring wall to centerline of track 2:	0 ft	Strip Load:	0 psf	491 psf for normal service	
Distance from face of shoring wall to centerline of track 3:	0 ft	Strip Load:	0 psf	50% Reduction Included	
Distance from face of shoring wall to centerline of track 4:	0 ft	Strip Load:	0 psf	25% Reduction Included	

Lateral Pressures Per AREMA Manual for Railway Engineering Chapter 8 Article 20.3.2.2 & Section 5.1

Depth d (ft)	Track 1 P _{s,1} (psf)	Track 2 P _{s,2} (psf)	Track 3 P _{s,3} (psf)	Track 4 P _{s,4} (psf)	Total P _{s,total} (psf)
0	0	0	0	0	0
1	85	0	0	0	85
2	157	0	0	0	157
3	208	0	0	0	208
4	237	0	0	0	237
5	248	0	0	0	248
6	245	0	0	0	245
7	234	0	0	0	234
8	217	0	0	0	217
9	198	0	0	0	198
10	179	0	0	0	179
11	161	0	0	0	161
12	143	0	0	0	143
13	128	0	0	0	128
14	113	0	0	0	113
15	101	0	0	0	101
16	90	0	0	0	90
17	80	0	0	0	80
18	71	0	0	0	71
19	64	0	0	0	64
20	57	0	0	0	57
21	51	0	0	0	51
22	46	0	0	0	46
23	42	0	0	0	42
24	38	0	0	0	38
25	34	0	0	0	34
26	31	0	0	0	31
27	28	0	0	0	28
28	26	0	0	0	26
29	24	0	0	0	24
30	22	0	0	0	22
31	20	0	0	0	20
32	18	0	0	0	18
33	17	0	0	0	17
34	16	0	0	0	16
35	15	0	0	0	15
36	13	0	0	0	13
37	13	0	0	0	13
38	12	0	0	0	12
39	11	0	0	0	11
40	10	0	0	0	10
41	9	0	0	0	9
42	9	0	0	0	9
43	8	0	0	0	8
44	8	0	0	0	8
45	7	0	0	0	7
46	7	0	0	0	7
47	6	0	0	0	6
48	6	0	0	0	6
49	6	0	0	0	6
50	5	0	0	0	5

d = depth below bottom of tie
P_{s,1} = lateral surcharge from track 1
P_{s,2} = lateral surcharge from track 2
P_{s,3} = lateral surcharge from track 3
P_{s,4} = lateral surcharge from track 4
P_{s,total} = combined lateral surcharge ΣP_{s,n}
P_{s,total,max} = 248 PSF
For "Simplified" Surcharge
P_{s,simple} = 198.4 PSF

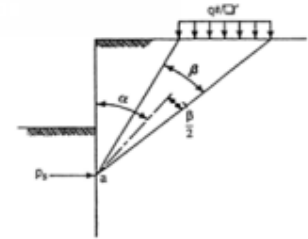

$$P_s = \frac{2g}{\pi} (\beta + \sin\beta \sin^2\alpha - \sin\beta \cos^2\alpha)$$

Note: α & β are in radians

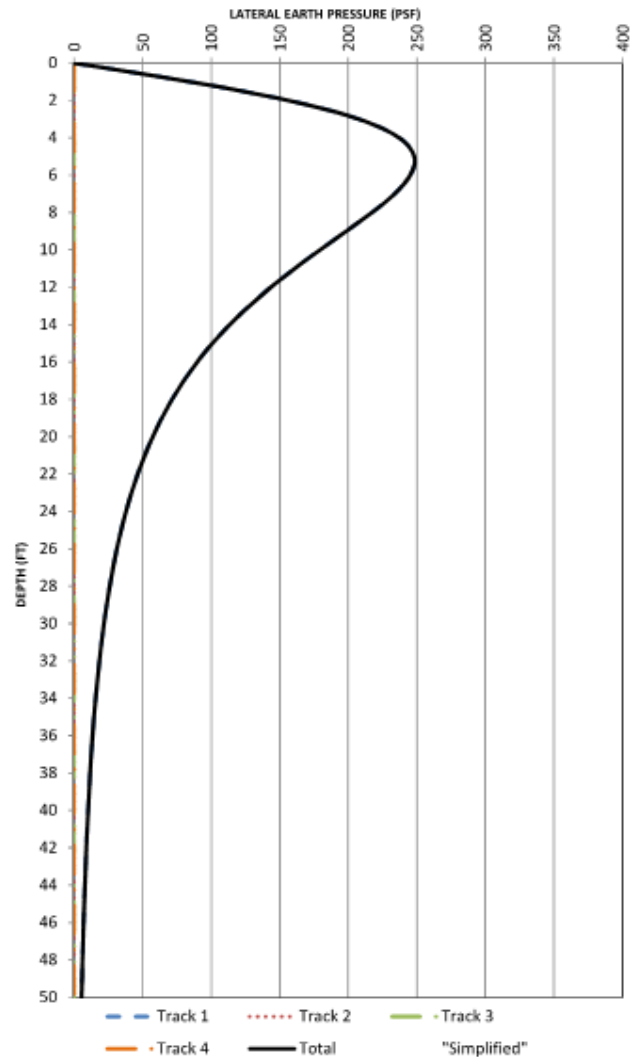

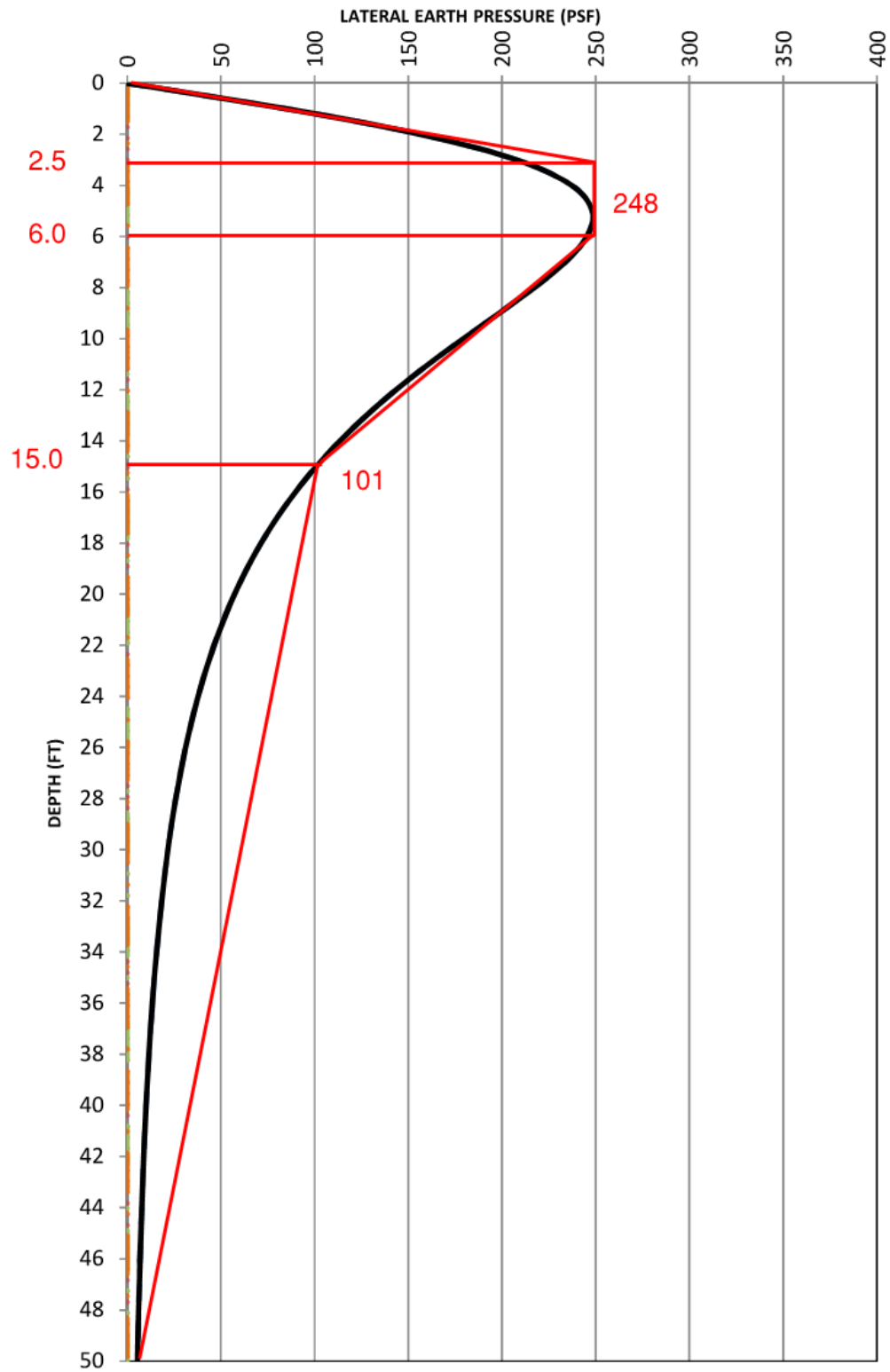



EXAMPLE 7.1 – CANTILEVER SOLDIER PILE AND LAGGING SHORING WALL

PROBLEM:

DETERMINE THE REQUIRED DEPTH OF PENETRATION AND THE DESIGN SHEAR AND MOMENT FOR A CANTILEVER SOLDIER PILE AND LAGGING WALL FOR THE SOIL CONDITIONS AND PILE SPACING INDICATED BELOW. RAILBOUND CRANE TRAIN WILL NOT OPERATE ON THIS TRACK, AND THE TRACKWORK WEIGHT CAN BE IGNORED FOR THIS PROBLEM. NO SPECIAL TREATMENT IS CONSIDERED FOR THE BOTTOM OF THE CUT SUCH AS MUD SLAB, GROUND STABILIZATION, ETC.

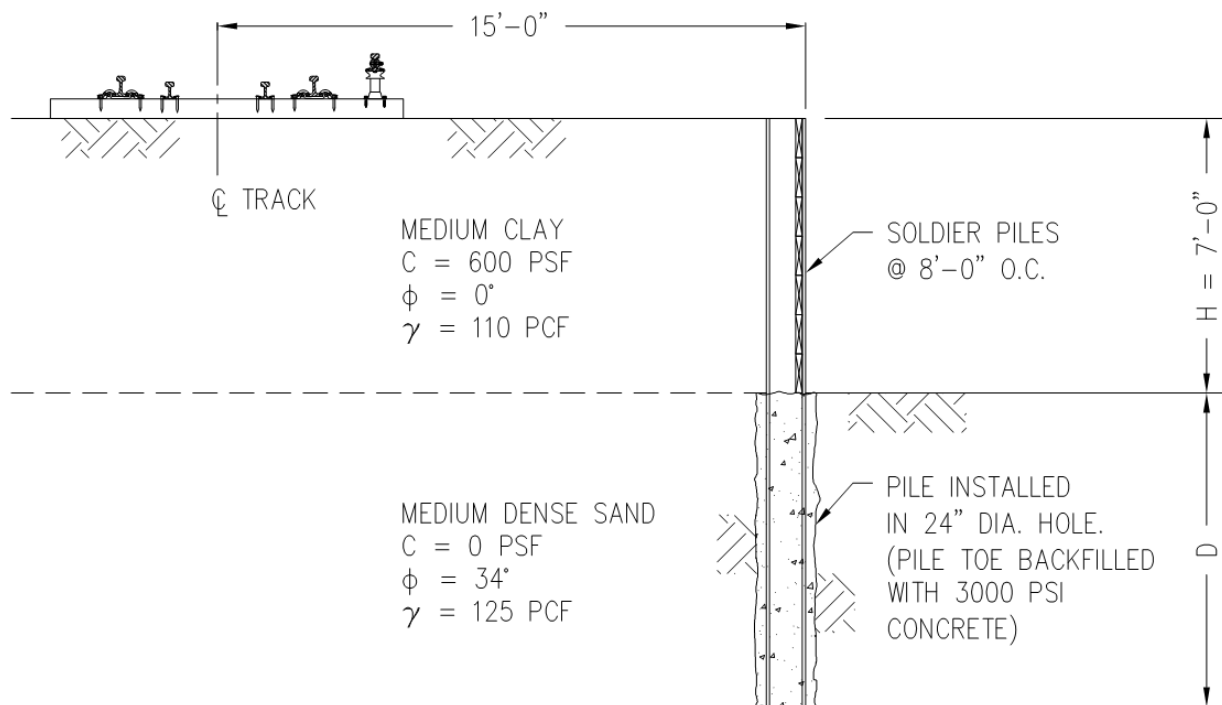

SOLUTION:

COMPUTE ACTIVE SOIL PRESSURES –

MEDIUM CLAY:

NO THEORETICAL NET ACTIVE PRESSURE BECAUSE

$$\gamma_{CLAY}H - 2C = 110(7) - 2(600) = -430 \text{ PSF} < 0$$

THEREFORE, USE 30 PSF/FT EPF MINIMUM ACTIVE PRESSURE.

MEDIUM DENSE SAND:



$$K_A = \tan^2(45^\circ - \phi/2) = \tan^2(45^\circ - 34^\circ/2) = \underline{\underline{0.28}}$$

$$\text{ACTIVE GRADIENT} = K_A \gamma_{\text{SAND}} = 0.28(125) = \underline{\underline{35 \text{ PSF/FT}}}$$

COMPUTE PASSIVE SOIL PRESSURE USING LOG-SPIRAL THEORY –

REFER TO EXAMPLE 4.3: $K_P = \underline{\underline{4.9}}$

$$\text{PASSIVE GRADIENT} = K_P \gamma_{\text{SAND}} = 4.9(125) = \underline{\underline{613 \text{ PSF/FT}}}$$

RAILROAD SURCHARGE –

SINCE THE SHORING WALL IS ZONE 3, “SIMPLIFIED” RAPID TRANSIT SURCHARGE IS ALLOWED FOR CANTILEVERED SYSTEM:

REFER TO NEXT PAGE: $P_S = \underline{\underline{101.6 \text{ PSF/FT}}}$

EFFECTIVE WIDTH OF EMBEDDED PORTION OF SOLDIER PILE –

PER SECTION 6.2 FOR COHESIVE SOIL

$$\text{EFFECTIVE WIDTH } (w_{EFF}) = 2d$$

WHERE d = DIAMETER OF CONCRETE FILLED DRILLED HOLE

$$w_{EFF} = 2(2) = 4 \text{ FT}$$

SINCE NO SPECIAL TREATMENT IS CONSIDERED AT THE BOTTOM OF THE CUT, FOR SOLDIER PILE SHORING WALLS, PER SECTION 6.2, A DEPTH OF 1.5 TIMES THE WIDTH OF THE SOLDIER PILE IN SOIL SHALL NOT BE CONSIDERED IN PROVIDING PASSIVE LATERAL SUPPORT.

$$1.5d = 1.5(2) = 3 \text{ FT}$$

USE “SIMPLIFIED” METHOD OF CANTILEVER PILE ANALYSIS.



Analysis Parameters

	Tie Length:	9 ft		
Distance from face of shoring wall to centerline of track 1:	15 ft	Strip Load:	491 psf	606 psf for crane train
Distance from face of shoring wall to centerline of track 2:	0 ft	Strip Load:	0 psf	491 psf for normal service
Distance from face of shoring wall to centerline of track 3:	0 ft	Strip Load:	0 psf	50% Reduction Included
Distance from face of shoring wall to centerline of track 4:	0 ft	Strip Load:	0 psf	25% Reduction Included

Lateral Pressures Per AREMA Manual for Railway Engineering Chapter 8 Article 20.3.2.2 & Section 5.1

Depth d (ft)	Track 1 P _{s,1} (psf)	Track 2 P _{s,2} (psf)	Track 3 P _{s,3} (psf)	Track 4 P _{s,4} (psf)	Total P _{s,total} (psf)
0	0	0	0	0	0
1	27	0	0	0	27
2	53	0	0	0	53
3	75	0	0	0	75
4	94	0	0	0	94
5	109	0	0	0	109
6	119	0	0	0	119
7	125	0	0	0	125
8	127	0	0	0	127
9	127	0	0	0	127
10	124	0	0	0	124
11	120	0	0	0	120
12	114	0	0	0	114
13	108	0	0	0	108
14	102	0	0	0	102
15	95	0	0	0	95
16	89	0	0	0	89
17	82	0	0	0	82
18	76	0	0	0	76
19	71	0	0	0	71
20	65	0	0	0	65
21	61	0	0	0	61
22	56	0	0	0	56
23	52	0	0	0	52
24	48	0	0	0	48
25	44	0	0	0	44
26	41	0	0	0	41
27	38	0	0	0	38
28	35	0	0	0	35
29	33	0	0	0	33
30	30	0	0	0	30
31	28	0	0	0	28
32	26	0	0	0	26
33	25	0	0	0	25
34	23	0	0	0	23
35	21	0	0	0	21
36	20	0	0	0	20
37	19	0	0	0	19
38	18	0	0	0	18
39	16	0	0	0	16
40	15	0	0	0	15
41	15	0	0	0	15
42	14	0	0	0	14
43	13	0	0	0	13
44	12	0	0	0	12
45	11	0	0	0	11
46	11	0	0	0	11
47	10	0	0	0	10
48	10	0	0	0	10
49	9	0	0	0	9
50	9	0	0	0	9

d = depth below bottom of tie
P_{s,1} = lateral surcharge from track 1
P_{s,2} = lateral surcharge from track 2
P_{s,3} = lateral surcharge from track 3
P_{s,4} = lateral surcharge from track 4
P_{s,total} = combined lateral surcharge ΣP_{s,n}
P_{s,total,max} = 127 PSF
For "Simplified" Surcharge
P_{s,simple} = 101.6 PSF

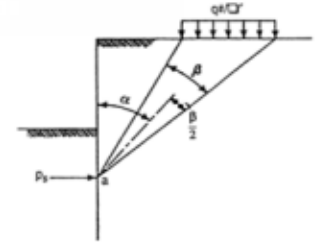

$$P_s = \frac{2q}{\pi}(\beta + \sin\beta \sin^2\alpha - \sin\beta \cos^2\alpha)$$

Note: α & β are in radians

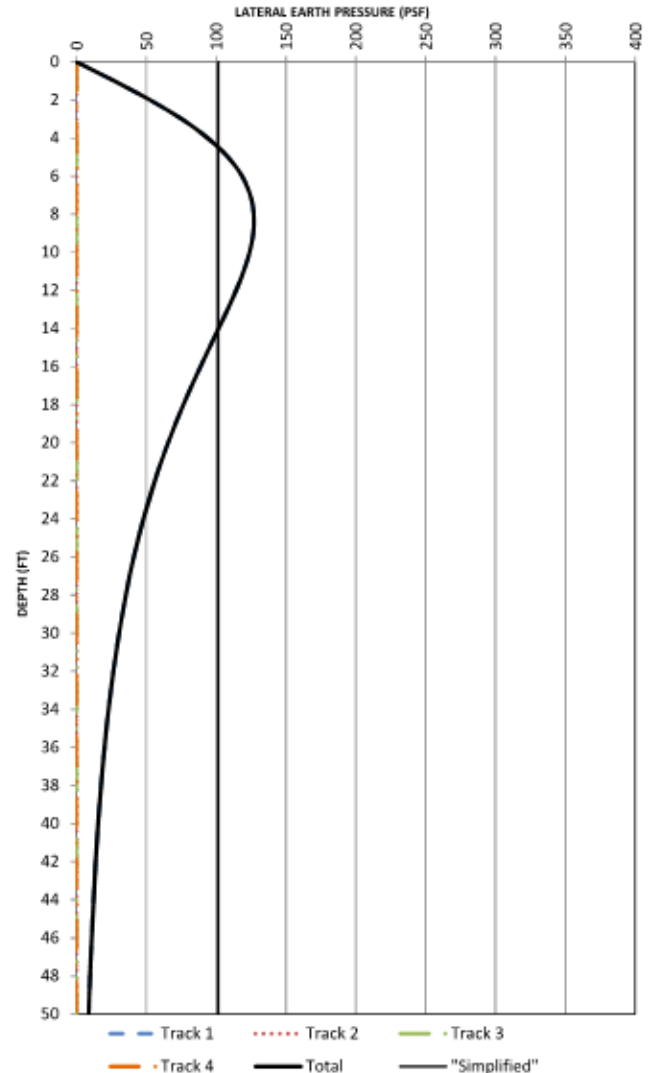

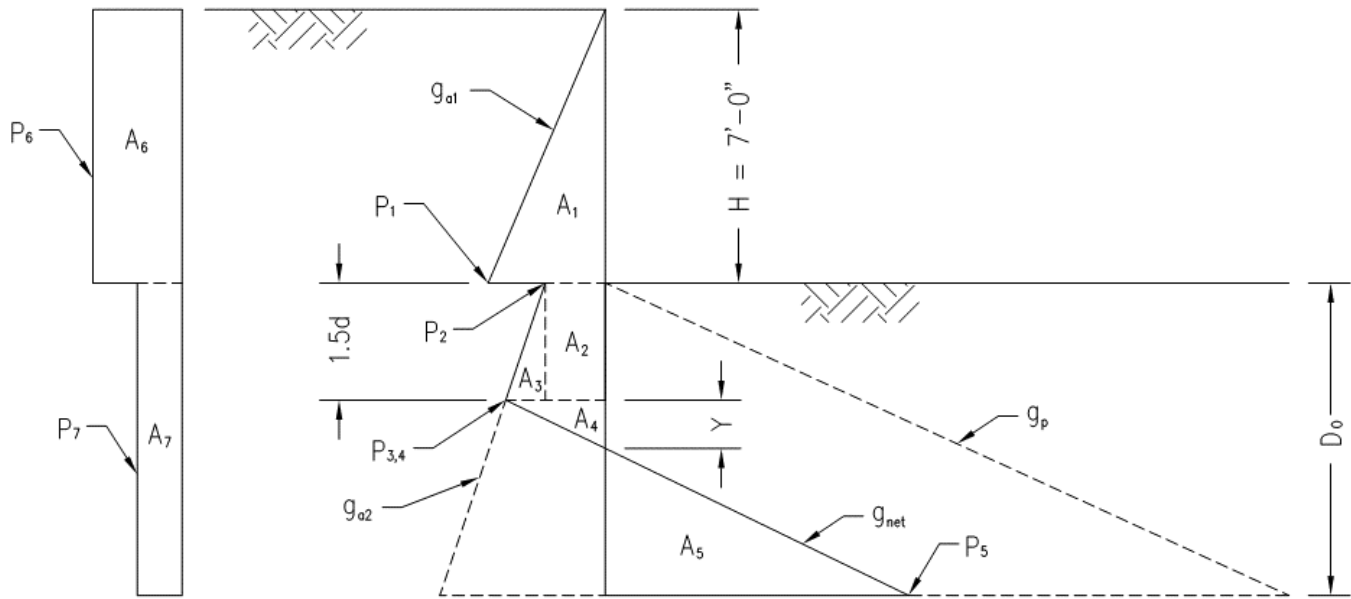

RT SURCHARGE

SOIL LOADING

$$g_{a1} = 30(\text{PILE SPACING}) = 30(8) = \underline{\underline{240 \text{ PSF}}}$$

$$g_{a2} = 35w_{EFF} = 35(4) = \underline{\underline{140 \text{ PSF}}}$$

$$g_p = 613w_{EFF} = 613(4) = \underline{\underline{2,452 \text{ PSF}}}$$

$$g_{net} = g_p - g_{a2} = 2,452 - 140 = \underline{\underline{2,312 \text{ PSF}}}$$

$$P_1 = g_{a1}H = 240(7) = \underline{\underline{1,680 \text{ LBS/FT}}}$$

$$P_2 = K_A \gamma_{CLAY} H w_{EFF} = 0.28(110)(7)(4) = \underline{\underline{862.4 \text{ LBS/FT}}}$$

$$P_{3,4} = P_2 + 1.5d(g_{a2}) = 862.4 + 1.5(2)(140) = \underline{\underline{1,282.4 \text{ LBS/FT}}}$$

$$P_5 = g_{net}(D_0 - 1.5d) - P_{3,4} = 2,312[D_0 - 1.5(2)] - 1,282.4 = \underline{\underline{2,312D_0 - 8,218.4 \text{ LBS/FT}}}$$

$$P_6 = P_5(\text{PILE SPACING}) = 101.6(8) = \underline{\underline{812.8 \text{ LBS/FT}}}$$

$$P_7 = P_5(w_{EFF}) = 101.6(4) = \underline{\underline{406.4 \text{ LBS/FT}}}$$

$$Y = P_{3,4}/g_{net} = 1,282.4/2,312 = \underline{\underline{0.55 \text{ FT}}}$$

$$A_1 = P_1(H/2) = 1,680(7/2) = \underline{\underline{5,880 \text{ LBS}}}$$



$$A_2 = P_2(1.5d) = 862.4(1.5)(2) = \underline{2,587.2 \text{ LBS}}$$

$$A_3 = (P_{3,4} - P_2)(1.5d)/2 = (1,282.4 - 862.4)(1.5)(2)/2 = \underline{630 \text{ LBS}}$$

$$A_4 = P_{3,4}(Y/2) = 1,282.4(0.55/2) = \underline{352.66 \text{ LBS}}$$

$$A_5 = P_5(D_0 - 1.5d - Y)/2 = (2,312D_0 - 8,218.4)(D_0 - 3 - 0.55)/2$$

$$= \underline{4,624D_0^2 - 32,852D_0 + 58,350.6 \text{ LBS}}$$

$$A_6 = P_6H = 812.8(7) = \underline{5,689.6 \text{ LBS}}$$

$$A_7 = P_7D_0 = \underline{406.4D_0 \text{ LBS}}$$

COMPUTE REQUIRED EMBEDMENT DEPTH –

SUM MOMENTS ABOUT BOTTOM OF WALL TO DETERMINE D_0 –

$$A_1(D_0 + H/3) + A_2(D_0 - 1.5d/2) + A_3\left(D_0 - \frac{2}{3}1.5d\right) + A_4(D_0 - 1.5d - Y/3)$$

$$-A_5(D_0 - 1.5d - Y)/3 + A_6(D_0 + H/2) + A_7(D_0/2) = 0$$

$$5,880(D_0 + 7/3) + 2,587.2(D_0 - 3/2) + 630\left(D_0 - \frac{2}{3}2\right) + 352.66(D_0 - 2 - 0.55/3)$$

$$-(4,624D_0^2 - 32,852D_0 + 58,350.6)(D_0 - 2 - 0.55)/3 + 5,689.6(D_0 + 7/2) +$$

$$406.4D_0(D_0/2) = 0$$

$$1,541.33D_0^3 - 15,084.24D_0^2 + 32,234.91D_0 - 77,740.68 = 0$$

SOLVE FOR D_0 :

$$D_0 = \underline{7.95 \text{ FT}}$$

INCREASE EMBEDMENT DEPTH BY 20% TO ACCOUNT FOR “SIMPLIFIED” ANALYSIS AND THEN ADD AN ADDITIONAL 40% FOR SAFETY FACTOR.

$$D = 1.4[1.2(D_0)] = 1.4[1.2(7.95)] = \underline{13.36 \text{ FT MINIMUM}}$$

PROVIDE 14 FT OF EMBEDMENT.



CHECK SECTION 6.8.1 FOR GENERAL REQUIREMENT FOR CANTILEVERED SHORING WALL:

$$14 \text{ FT} > H = 7 \text{ FT OK}$$

DETERMINE DESIGN SHEAR FORCE –

MAXIMUM SHEAR FORCE IS AT BOTTOM OF PILE

$$V_{MAX} = A_5 - A_1 - A_2 - A_3 - A_4 - A_6 - A_7$$

$$[(4,624D_0^2 - 32,852D_0 + 58,350.6) - 5,880 - 2,587.2 - 630 - 352.66 - 5,689.6 - 406.4D_0]/1000$$

$$V_{MAX} = \underline{\underline{71.06 \text{ KIPS}}}$$

DETERMINE DESIGN MOMENT –

FIND POINT OF ZERO SHEAR (depth of X below bottom of excavation)

$$A_1 + A_2 + A_3 + A_4 + A_6 + P_7X - P_5(X - 1.5d - Y)/2 = 0$$

$$5,880 + 2,587.2 + 630 + 352.66 + 5,689.6 + 406.4X - (2,312X - 8,218.4)$$

$$(X - 3 - 0.55)/2 = 0$$

$$1,156X^2 - 8,619.4X + 551.8 = 0$$

SOLVE FOR X:

$$X = \underline{\underline{7.52 \text{ FT}}}$$

$$M_{MAX} = [A_1(X + H/3) + A_2(X - 1.5d/2) + A_3\left(X - \frac{2}{3}1.5d\right) + A_4(X - 1.5d - Y/3)$$

$$+ A_6(X + H/2) + P_7X^2/2 - P_5(X - 1.5d - Y)^2/6]/1000$$

$$= \{5,880(7.52 + 7/3) + 2,587.2(7.52 - 3/2) + 630(7.52 - 6/3) + 352.66(7.52 - 2 -$$

$$0.55/3) + 5,689.6(7.52 + 7/2) + 406.4(7.52)(7.52)^2/2 - [2,312(7.52) - 8,218.4]$$

$$(7.52 - 3 - 0.55)^2/6\}/1000$$

$$M_{MAX} = \underline{\underline{203.90 \text{ KIP} \cdot \text{FT}}}$$



EXAMPLE 7.2 – SHEET PILE SHORING WALL WITH ONE LEVEL OF BRACING (FREE EARTH SUPPORT METHOD)

EXAMPLE 7.3 – SHEET PILE SHORING WALL WITH ONE LEVEL OF BRACING (FIXED EARTH SUPPORT METHOD)

EXAMPLE 7.4 – ANALYSIS OF A DIAPHRAGM SHORING WALL WITH THREE LEVELS OF BRACING

(These examples will be provided in later revisions)



EXAMPLE 8.1 – WIDE FLANGE WALER DESIGN

PROBLEM:

SIZE A WALER FOR THE FOLLOWING BRACING GEOMETRY AND LOADING.

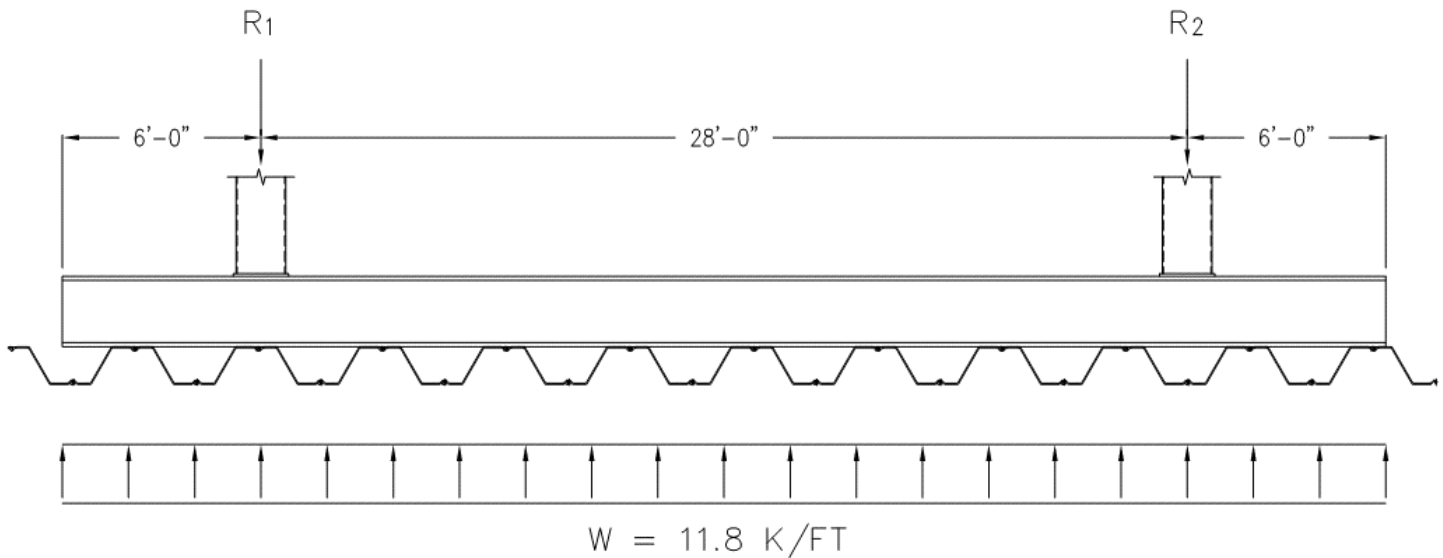

SOLUTION:

ANALYZE WALER TO DETERMINE DESIGN MOMENT AND SHEAR –

$$M_{MAX} = 11.8(28)^2/8 - 11.8(6)^2/2 = \underline{\underline{944 \text{ KIP} \cdot \text{FT}}}$$

$$V_{MAX} = 11.8(28)/2 = \underline{\underline{165.2 \text{ KIPS}}}$$

$$\text{STRUT LOADS} = R_1 = R_2 = 11.8(40)/2 = \underline{\underline{236 \text{ KIPS}}}$$

ASSUMPTIONS –

USE GRADE 36 WIDE FLANGE BEAM FOR WALER

COMPRESSION FLANGE IS CONTINUOUSLY BRACED BY SHEET PILING, THEREFORE, LATERAL TORSIONAL BUCKLING FAILURE STATE WILL NOT CONTROL.

$$F_b = 0.55F_y = 0.55(36) = \underline{\underline{19.8 \text{ KSI}}}$$

$$F_v = 0.35F_y = 0.35(36) = \underline{\underline{12.6 \text{ KSI}}}$$

$$S_{REQD} = M_{MAX}/F_b = 944(12)/19.8 = \underline{\underline{572.12 \text{ IN}^3}}$$



$$A_{WEB,REQD} = V_{MAX}/F_v = 165.2/12.6 = \underline{\underline{13.11 IN^2}}$$

<u>ACCEPTABLE SIZES</u>	S (in ³) (Note 2)	A _{WEB} (in ²)
W24X229	588	24.96
W27X217	627	23.57
W30X191	600	20.11

OTHER ACCEPTABLE SIZES ARE AVAILABLE.

NOTES:

1. STIFFENERS AT POINTS OF BEARING ARE NOT SHOWN AND THE DESIGN IS NOT INCLUDED IN THIS DESIGN EXAMPLE.
2. AISC SPECIFICATION ALLOWS THE USE OF PLASTIC SECTION MODULUS WHEN CALCULATING BENDING CAPACITY. HOWEVER, ONLY ELASTIC SECTION MODULUS WILL BE PERMITTED IN THIS MANUAL.



EXAMPLE 8.2 – PIPE STRUT DESIGN

PROBLEM:

DESIGN A PIPE STRUT FOR THE STRUT LOAD (236 KIPS) COMPUTED IN EXAMPLE 8.1. ASSUME STRUT LENGTH (UNBRACED) IS 38 FEET.

SOLUTION:

DETERMINE MINIMUM CROSS-SECTIONAL AREA REQUIRED BASED ON THE 12 KSI MAXIMUM AXIAL STRESS CRITERION IN SECTION 7.1.1 –

$$A_{REQD} = STRUT\ LOAD / 12 = 236 / 12 = \underline{19.67\ IN^2}$$

TRY 18" DIA. X 3/8" WALL THICKNESS PIPE, ASTM A252, GRADE 2 ($F_y = 35\ KSI$) –

PIPE PROPERTIES

$$A = 19.4\ IN^2$$

$$I = 754\ IN^4$$

$$r = 6.24\ IN$$

$$S = 83.8\ IN^3$$

CHECK WIDTH-TO-THICKNESS RATIO FOR COMPRESSION ELEMENTS MEMBERS SUBJECT TO FLEXURE PER AISC SINCE AREMA DOES NOT HAVE PIPE SHAPE. DESIGN WALL THICKNESS SHALL BE TAKEN EQUAL TO 0.93 TIMES THE NOMINAL WALL THICKNESS PER AISC SPECIFICATION B4.2.

$$D/t = 18 / [0.93(3/8)] = 51.6 < 0.07 E / F_y = 0.07^{29,000} / 35 = 58$$

SECTION IS COMPACT. LOCAL BUCKLING IS NOT A CONCERN.

$$WEIGHT\ (W) = 71\ LBS/FT$$

$$M_{SELF\ WEIGHT} = WL^2 / 8 = 71(38)^2 / 8 = 12,816\ LB \cdot FT = \underline{12.82\ KIP \cdot FT}$$

CHECK SLENDERNESS RATIO PER AREMA –

$$k = 7/8 \quad \text{FOR MEMBERS WITH PIN-END CONNECTIONS}$$

$$kl/r = 7/8(38)(12) / 6.24 = 63.94 < 100\ O.K.$$

COMPUTE STRESSES –



$$f_a = \text{STRUT LOAD}/A = 236/19.4 = \underline{12.16 \text{ KSI}} > 12 \text{ KSI CONSIDER O.K.}$$

$$f_b = M_{\text{SELF WEIGHT}}/S = 12.82(12)/83.8 = \underline{1.84 \text{ KSI}}$$

COMPUTE ALLOWABLE STRESSES –

AXIAL COMPRESSION –

$$0.62/\sqrt{F_y/E} = 0.62/\sqrt{35/29,000} = 17.85$$

$$5.034/\sqrt{F_y/E} = 5.034/\sqrt{35/29,000} = 144.90$$

$$0.62/\sqrt{F_y/E} = 17.85 < kl/r = 63.94 < 5.034/\sqrt{F_y/E} = 144.90$$

$$F_a = 0.60F_y - \left(17,500 \frac{F_y}{E}\right)^{3/2} (kl/r)$$

$$= 0.60(35) - \left(17,500 \frac{35}{29,000}\right)^{3/2} (63.94)/1,000 = \underline{14.79 \text{ KSI}}$$

BENDING –

AREMA DOES NOT HAVE ALLOWABLE STRESSES FOR PIPE SHAPE. ALLOWABLE BENDING STRESS FOR ROLLED BEAMS IS PERMITTED TO USE.

$$F_b = 0.55F_y - \frac{0.55(F_y)^2}{6.3\pi^2 E} (l/r)^2 = 0.55(35) - \frac{0.55(35)^2}{6.3\pi^2(29,000)} \left[\frac{38(12)}{6.24}\right]^2 = \underline{17.25 \text{ KSI}}$$

COMPUTE COMBINED STRESSES –

$$f_a/F_a = 12.16/14.79 = 0.82 > 0.15$$

$$\frac{f_a}{F_a} + \frac{f_b}{F_b \left[1 - \frac{f_a}{0.514\pi^2 E} \left(\frac{kl}{r}\right)^2\right]} = 0.82 + \frac{1.84}{14.79 \left[1 - \frac{12.16}{0.514\pi^2(29,000)} (63.94)^2\right]}$$

$$= 0.82 + 0.19 = \underline{1.01} \text{ 1\% OVERSTRESSED. SAY O.K.}$$

18" DIA. X 3/8" WALL THICKNESS (ASTM A252, GRADE 2) PIPE IS ACCEPTABLE.



EXAMPLE 8.3 – SHORING WALL DESIGN

PROBLEM:

THE DESIGN BENDING MOMENT FOR A SHORING WALL IS 84 KIP-FT PER LINEAL FOOT. SIZE THE FOLLOWING SHORING WALL MEMBERS FOR THIS DESIGN MOMENT*:

- (A) STEEL SHEET PILES
- (B) SOIL-MIX WALL PILES INSTALLED @ 4'-0" ON CENTER

*NOTE: OTHER FACTORS NOT CONSIDERED IN THIS EXAMPLE (e.g., SHORING WALL STIFFNESS REQUIRED TO LIMIT WALL DEFLECTION, AXIAL LOAD IN SHORING WALL PILES, ETC.) MAY AFFECT THE DESIGN OF SHORING WALL MEMBERS.

SOLUTION:

- (A) STEEL SHEET PILES

HOT-ROLLED SHEET PILES CONFORM TO ASTM A328 GRADE 50

COLD-ROLLED SHEET PILES CONFORM TO ASTM A572 GRADE 50

$$F_y = 50 \text{ KSI}$$

$$F_b = 65\%F_y = 65\%(50) = 32.5 \text{ KSI}$$

$$S_{REQD} = M_{DESIGN}(12)/F_b = 84(12)/32.5 = 31.02 \text{ IN}^3/\text{FT}$$

<u>ACCEPTABLE SHEET PILE SECTIONS</u>	S (in ³ /ft)
AZ 23-800 (HOT ROLLED)	43.3
PZ 35 (HOT ROLLED)	48.5
SKZ 31 (COLD ROLLED)	0.9(51.56) = 46.40

OTHER ACCEPTABLE SHEET PILE TYPES ARE AVAILABLE.

- (B) SOIL-MIX WALL PILES INSTALLED AT 4'-0" ON-CENTER

ASSUME PILE STEEL CONFORMS TO ASTM A572, GRADE 50

$$F_y = 50 \text{ KSI}$$

$$F_b = 0.55F_y = 0.55(50) = 27.5 \text{ KSI}$$



$$S_{REQD} = M_{DESIGN}(PILE\ SPACING)(12)/F_b = 84(4)(12)/27.5 = 146.418\ IN^3/PILE$$

ACCEPTABLE PILE SIZES

S (in³/pile)

W18X86

166

W21X73

151

W24X68

154

OTHER ACCEPTABLE PILE SIZES ARE AVAILABLE.



EXAMPLE 8.4 – WOOD LAGGING DESIGN

PROBLEM:

DETERMINE THE WOOD LAGGING THICKNESS REQUIRED FOR THE SHORING GEOMETRY ILLUSTRATED BELOW.

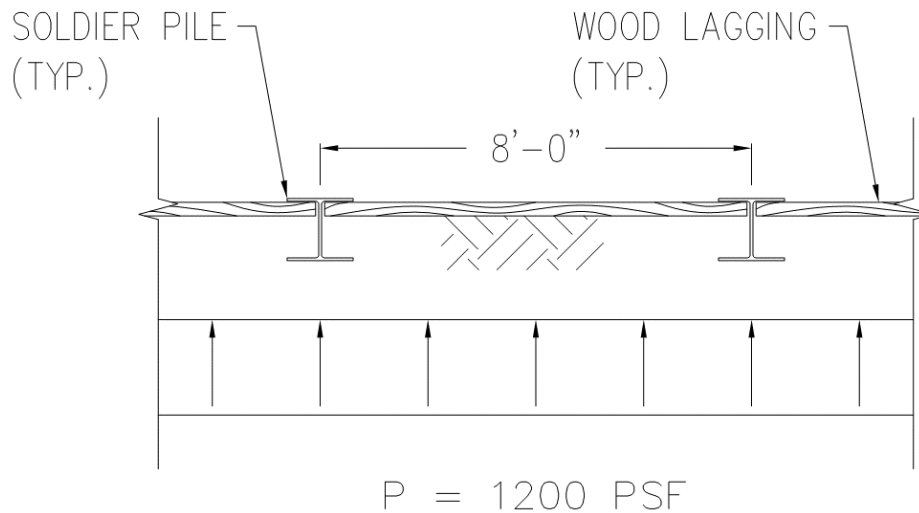

SOLUTION:

COMPUTE LAGGING DESIGN LOADING –

$$P_{LAGGING} = \frac{2}{3}P = \frac{2}{3}(1200) = \underline{\underline{800 \text{ PSF}}}$$

COMPUTE M_{MAX} AND V_{MAX} –

$$M_{MAX} = P_{LAGGING}(PILE \ SPACING)^2/8 = 800(8)^2/8 = \underline{\underline{6,400 \text{ LB} \cdot \text{FT}/\text{FT}}}$$

$$V_{MAX}^* = P_{LAGGING}(PILE \ SPACING)/2 = 800(8)/2 = \underline{\underline{3,200 \text{ LB}/\text{FT}}}$$

(*CONSERVATIVE, V_{MAX} CAN BE TAKEN CENTER OF FLANGE BEARING)

TRY 6X, S4S (THICKNESS = 5½"), DOUGLAS FIR NO. 2 MATERIAL –

$$A = 5.5(12) = 66 \text{ IN}^2/\text{FT}$$

$$S = 12(5.5)^2/6 = 60.5 \text{ IN}^3/\text{FT}$$

CHECK BENDING AND SHEAR –



$$f_b = M_{MAX}(12)/S = 6,400(12)/60.5 = \underline{\underline{1,269.42 \text{ PSI} < 1,500 \text{ PSI O.K.}}}$$

$$f_v = 3V_{MAX}/2A = 3(3,200)/2(66) = \underline{\underline{72.73 \text{ PSI} < 140 \text{ PSI O.K.}}}$$

6X, S4S, DOUGLAS FIR NO.2 MATERIAL IS ACCEPTABLE.



Appendix D – Table of Minimum Wall Thickness for Steel Casing Pipe for Jack-and-Bore Construction

APPENDIX D – TABLE OF MINIMUM WALL THICKNESS FOR STEEL CASING PIPE FOR JACK-AND-BORE CONSTRUCTION

PIPE SIZE (INCHES)	WALL THICKNESS (INCHES) (PROTECTED)
10	0.375
12	0.375
14	0.375
16	0.375
18	0.375
20	0.375
22	0.375
24	0.375
26	0.375
28	0.406
30	0.469
32	0.501
34	0.532
36	0.532
38	0.569
40	0.569
42	0.569
44	0.594
46	0.688
48	0.688
50	0.688
52	0.813
54	0.813
56	0.876
58	0.876
60	0.876
62	0.876
64	0.876
66	0.876
68	0.876
70	0.906

Note: For unprotected pipe 26” and under, add 0.032” to protected wall thickness. For unprotected pipe 28” and over, add 0.063” to protected wall thickness.



(This page intentionally left blank.)



APPENDIX E – MONITORING/SURVEY RESULTS REPORTING FORMS

Reporting Static Top of Running Rail Survey Results

Point No.	Station	Baseline T/Rail Elevation (Date) MM/DD/YYYY			Surveyed Static T/Rail Elevation (Today's Date) MM/DD/YYYY			Static T/Rail Change from Previous Survey Date) MM/DD/YYYY			Static T/Rail Change from Baseline		
		E _L	E _R	E _{avg}	E _L	E _R	E _{avg}	ΔE _L	ΔE _R	ΔE _{avg}	ΔE _L	ΔE _R	ΔE _{avg}
1	100+00												
2	100+10												
3	100+20												
.	.												
.	.												
.	.												
n													

Reporting Dynamic Measurement Results

Point No.	Station	Baseline Dynamic Movements (Date) MM/DD/YYYY			Measured Dynamic Movements (Today's Date) MM/DD/YYYY			Dynamic Change from Previous (Previous Survey Date) MM/DD/YYYY			Dynamic Change from Baseline		
		Total		Cross-Slope	Total		Cross-Slope	Total		Cross-Slope	Total		Cross-Slope
		δ _L	δ _R	δ _{avg}	δ _L	δ _R	δ _{avg}	δ _{cs} = δ _L - δ _R	Δδ _L	Δδ _R	Δδ _{avg}	Δδ _{cs} = Δδ _L - Δδ _R	Δδ _{cs} = Δδ _L - Δδ _R
1	100+00												
2	100+10												
3	100+20												
.	.												
.	.												
n													



(This page intentionally left blank.)



APPENDIX F – COMMENTARY

The commentary is not a part of the Adjacent Construction Manual, but is included for informational purposes only unless otherwise noted in the Manual.

The Commentary furnishes background information and references for the benefit of the design professional seeking further understandings of the basis, derivations, and limits of the Manual.



SECTION 1 INTRODUCTION COMMENTARY

C1.1 PURPOSE¹

AREMA *Manual for Railway Engineering* Chapter 8 – Concrete Structures and Foundations Part 28 – Temporary Structures for Construction Article 28.1.1 (c) recommends “all temporary structures anticipated to be in service for more than an 18-month period are not within the scope of these specifications”. The 18-month period required by AREMA *Manual for Railway Engineering* applies mostly to heavier passenger/freight trains, which usually has a lower average daily train traffic. CTA system, on the other hand, has a significantly higher average daily train traffic. Therefore, the period length is decided to be reduced to one year. For long-term permanent earth-retention structures, the cohesive soil cohesion may be omitted and treated as cohesionless soil.

C1.5 DEFINITIONS²

The strut to soldier pile or waler connection utilizing a single gusset/knife plate can be problematic. Such gusset/knife plate must satisfy the non-compact limit of $b/t > 95/F_y^{0.5}$ which may often be ignored for a temporary construction, otherwise a significant reduction in allowable stress can occur when the plate is considered slender. Secondly, field installation modifications to these gusset/knife plates such as gaps between gusset/knife plate and soldier pile or waler flange and angle of strut intersection with the said members may often be susceptible to significant stress increase. In order to avoid this concern, construction tolerances must be specified and taken into account during the design phase, which is often neglected for a temporary construction. Finally, it is impossible to predict the movement of the shoring wall and the gusset/knife plate connecting waler, which with such movement, some rotation will be introduced into the gusset/knife plate and result in additional bending stress that cannot be accounted for in design phase. For these reasons, CTA Engineering has decided not to allow gusset/knife plate connections.



SECTION 2 SUBMITTAL REQUIREMENTS COMMENTARY

(This page reserved for future commentary for Section 2)



SECTION 3 BASIC CONSTRUCTION AND EXCAVATION REQUIREMENTS COMMENTARY

C3.1 ZONE OF INFLUENCE^{3,4, 5, 6}

For utility works with depth less than 12 feet, the Contractor is generally permitted to move the utility alignment for up to 2 feet in all directions without the need to go through OUC review. With this permission from OUC, it brought up concerns that a previous reviewed and approved excavation that showed outside the CTA Zone of Influence or outside a specific Zone would change. The primary concern is for example, a previously design ERS soldier pile with lagging system approved in Zone 3, based on field condition needs to be moved towards the CTA tracks and enters Zone 2. The new requirement by assuming proposed utility alignments are 2 feet closer to CTA structures in the worst-case scenario can address this concern. However, this requirement may be waived by a Variance Request if the proposed utility is in Zone 4 and more than 2 feet away from Zone 3.

Per AREMA *Manual for Railway Engineering* Chapter 8 Article 28.5.1.1 – Restrictions of Use for cantilever sheet pile walls, where it states, “if used for shoring adjacent to an operating track the wall should be at least ten (10) feet away from the centerline of track, and its maximum height shall not exceed ten (10) feet.” Figure C2-1 shows the lateral pressure based on criteria from AREMA *Manual for Railway Engineering* shown above and cooper E80 loading condition. Figure C2-2 shows the lateral pressure based on criteria for Zone 2 in this Manual with CTA train loading condition.

Cantilever walls undergo large lateral deflections and the member stresses increase rapidly with height. Therefore, it is important to restrict the maximum height of the wall and ensure existence of good quality soil below the excavation line that can provide adequate passive resistance. The maximum lateral pressure occurs at a higher elevation with Zone 2 requirements in this Manual comparing to the AREMA *Manual for Railway Engineering* criteria. Previous experience shows for the normal size sheet piling, when cantilever height exceeds six (6) feet the maximum deflection at the top of the sheet piling wall exceeds 1/4 inch. Therefore, for Zone 2 the maximum cantilever height for sheet piling is restricted to four (4) feet. This cantilever height limitation also avoids the cantilevered sheet pile from being stressed with the maximum lateral pressure that can occur.

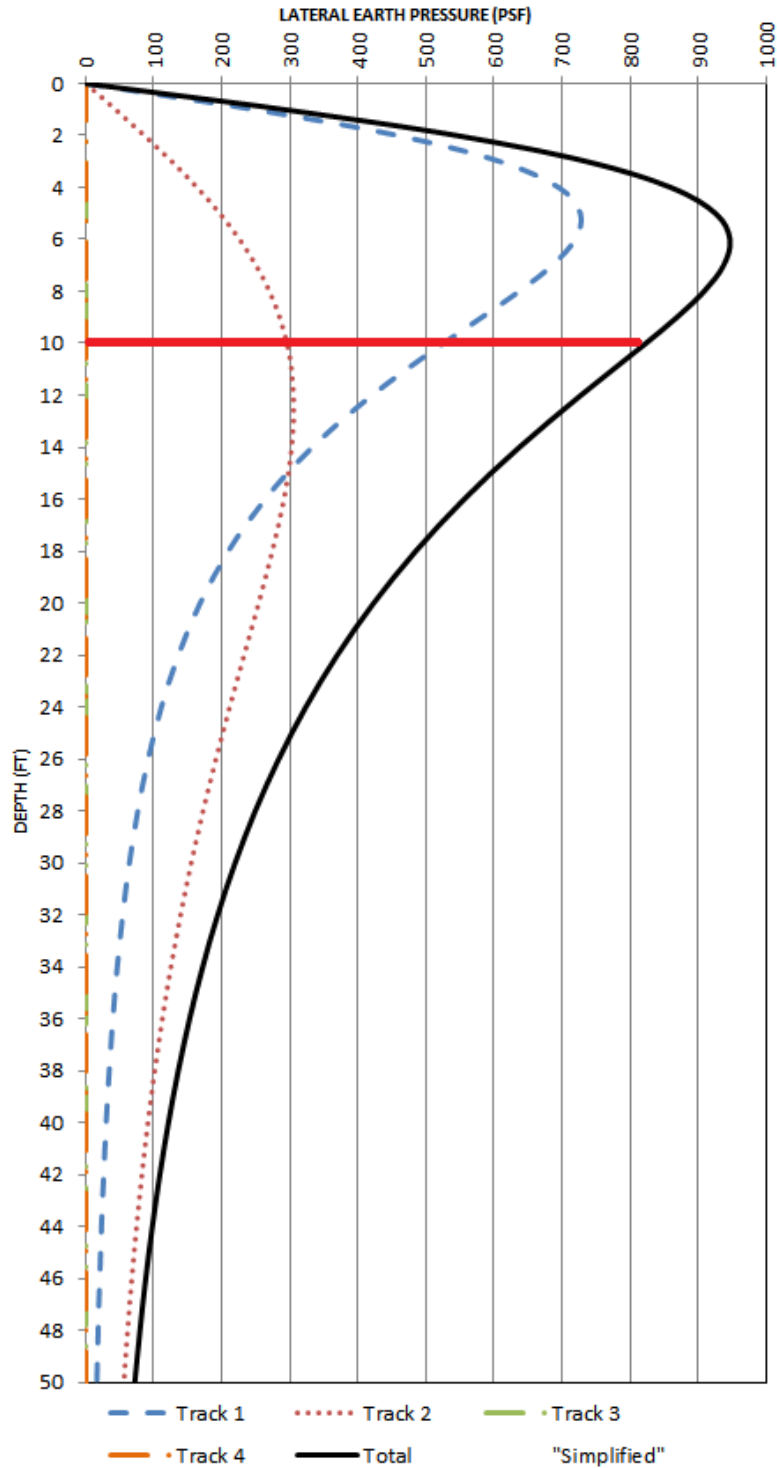

Figure C2-1: Lateral Pressure AREMA Cooper E80 Loading 10' from CL Adjacent Track (2 Tracks considered)

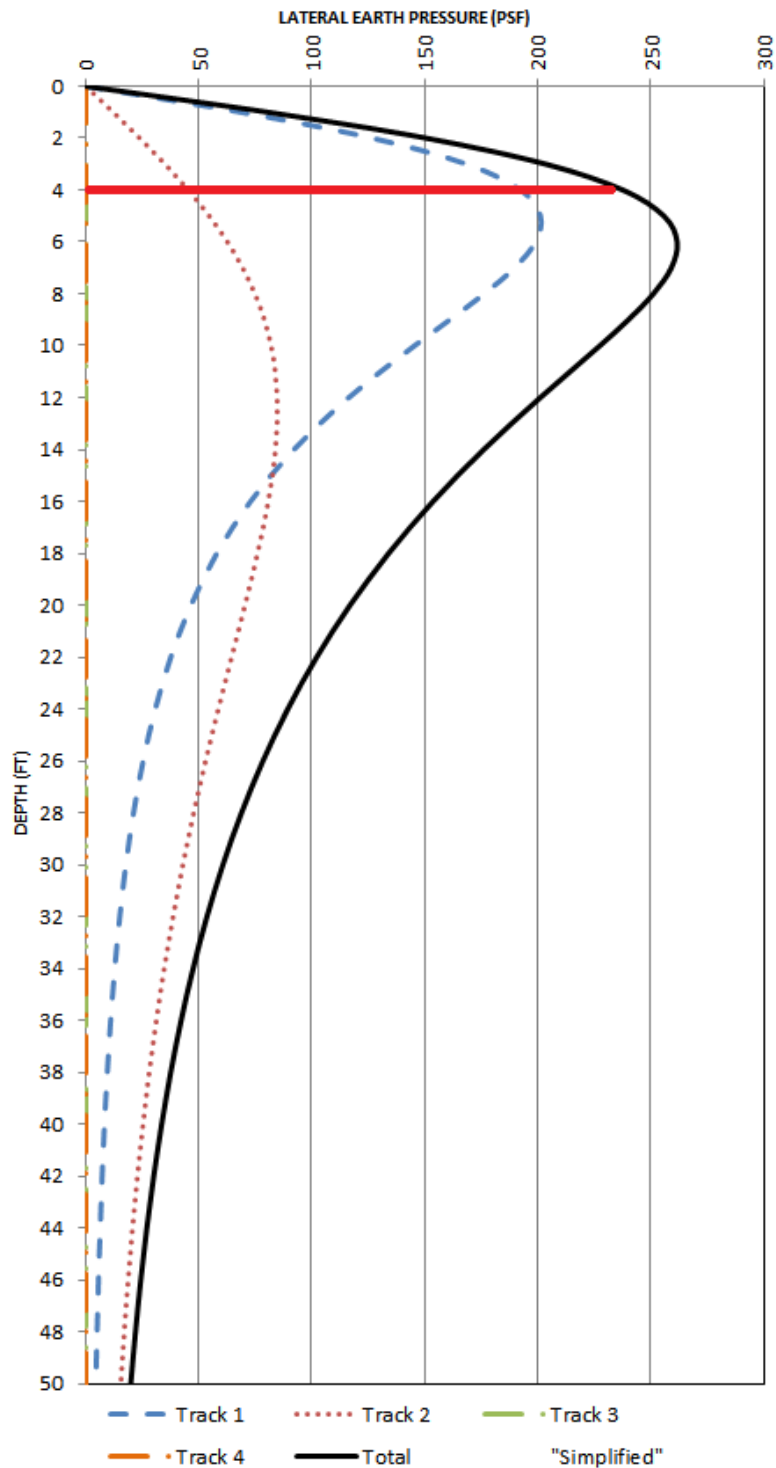

Figure C2-2: Lateral Pressure CTA Train Loading 5'-7" from CL Adjacent Track (2 Tracks considered)

Per AREMA *Manual for Railway Engineering* Chapter 8 Article 28.5.3.1 – Restrictions of Use for cantilever soldier beam with lagging walls, where it states, “if used for shoring adjacent to an



operating track the wall should be at least 13 feet away from the centerline of track, and its maximum height shall not exceed eight feet". Figure C2-3 shows the lateral pressure based on criteria from AREMA *Manual for Railway Engineering* shown above and Cooper E80 loading condition. Figure C2-4 shows the lateral pressure based on criteria for Zone 3 in this Manual with CTA train loading condition.

A cantilever soldier pile wall behaves similarly to a cantilever sheet pile wall. Due to the rapid increase in deflections and moments with the wall height, maximum height restrictions needed to be imposed. With the maximum lateral pressure elevation generally lower due to the increased distance from the shoring wall to the centerline of track, it is reasonable and practicable to avoid loading the cantilevered shoring wall with the maximum lateral pressure. Therefore, for Zone 3 the maximum cantilever height for flexible shoring walls is restricted to six (6) feet.

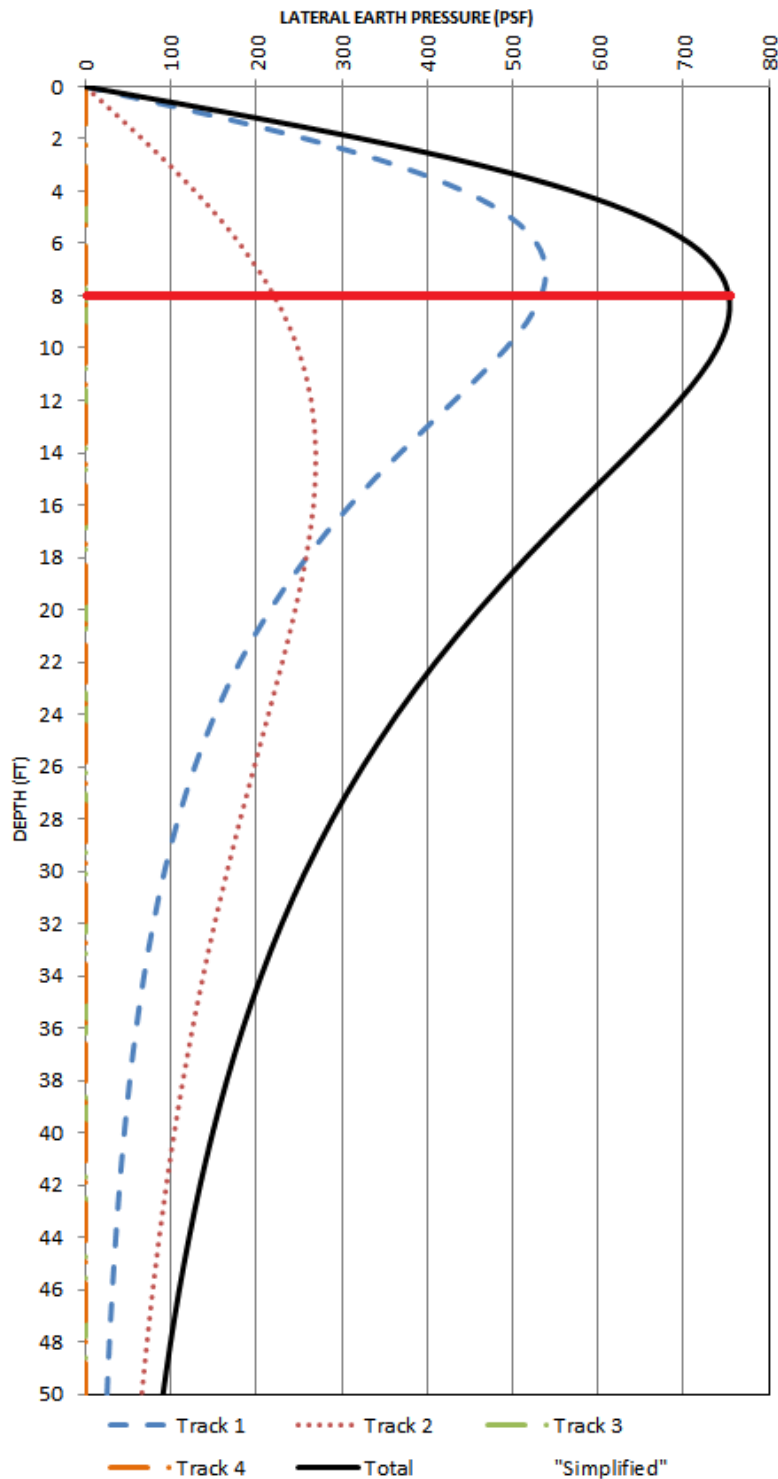

Figure C2-3: Lateral Pressure AREMA Cooper E80 Loading 13' from CL Adjacent Track (2 Tracks considered)

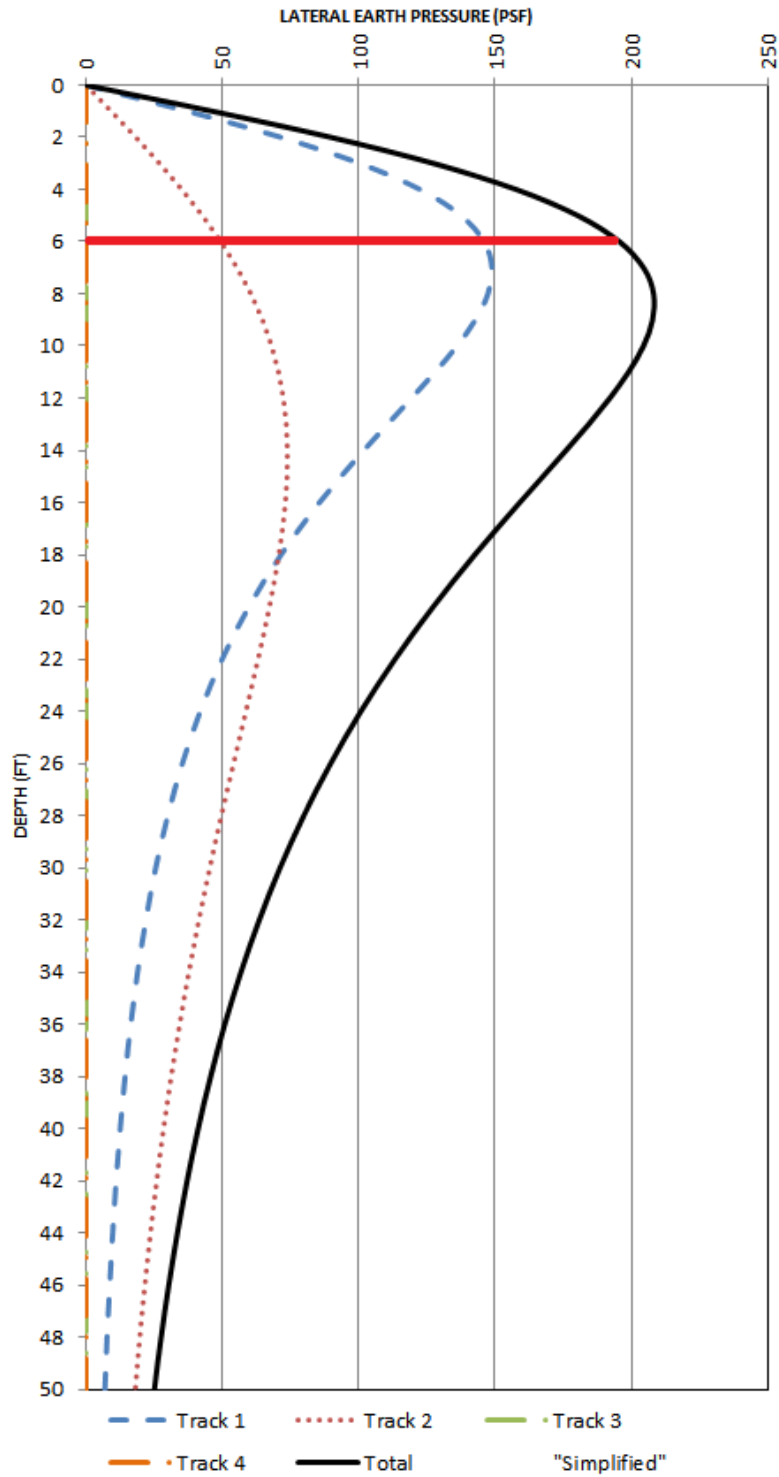

Figure C2-4: Lateral Pressure CTA Train Loading 8'-6" from CL Adjacent Track (2 Tracks considered)



The condition of the ballast section and the amount of ballast at the ends of the ties is considered very important to the lateral stability of the track, especially at curved tracks. The 12-inch minimum dimension for tangent tracks is considered sufficient for wind force on train or nosing force and is recommended by AREMA *Manual for Railway Engineering*. For Continuously Welded Rail at curved track locations, the ballast shoulder width is important and should be evaluated if disturbed and shall be restored immediately. For reference purposes, the following commentary is provided to determine the ballast shoulder width.

The equation determining Ballast Side Slope run (BSS) which is also called Ballast Shoulder Width is recommended to be calculated by the provision in AREMA *Manual for Railway Engineering* Chapter 16 – Economics of Railway Engineering and Operations Part 10 – Construction and Maintenance Operations Article 10.3.2.2 – Width of Ballast Shoulder at Ends of Ties, where it states “the forces necessary to move a tie buried to a depth of 4 inches in ballast, having a 6-inch ballast shoulder and carrying no vertical load is approximately 300 lb.” Linear interpolation is permitted by AREMA *Manual for Railway Engineering*. Vertical train live loads provide significant hold-down force, however, because track buckling often occurs immediately ahead of a moving train due to the rail uplift “wave” described by Talbot equation, train live load should be ignored.



SECTION 4 TEMPORARY SHORING SYSTEM COMMENTARY

C4.3 PROHIBITED SHORING TYPES⁷

Earth Retention Systems with elements installed and left in place in Zone 1 are not preferred due to future possible excavation such as track/ballast replacement etc. Therefore, systems included in this section are not allowed.

Soil nailing and helical screw anchors are strictly prohibited for the following reasons:

- Performances highly depend on the soil condition, where cohesive soils that have good stand-up time are required. For track drainage purposes, the fill within the Zone of Influence is usually granular engineered fill.
- Systems are not pre-loaded and require relatively large movement to mobilize the passive pressure. Therefore, deflections for this type of system are higher than other systems.

Tieback wall system is not permitted for the same reason shown above except that tiebacks are left in place in Zone 1. However, tieback wall system may be accepted by CTA if any other alternate is not practical since tiebacks are pre-loaded/tested, and the system works in most soil conditions.

Micropiles with laggings system is not permitted since micropiles are slender elements and should not be statically loaded in bending. In addition, the typical threaded joint used in the oil industry can only achieve 50% of the bending capacity of the intact casing. Structural welding may also be a concern since the typical N80 oil pipe has lower carbon composition than the structural steel type. The soundness of the welds is difficult to control. However, the use of micropiles with laggings system may be accepted by CTA if warranted by the low headroom clearance. 100% bending capacity of the intact casing can be achieved at the threaded joint by providing an inner casing extending a certain distance each side of the joint to reinforce the threaded joint. If the Designer in Responsible Charge elects to use only the threaded joint, the bending strength at the threaded joint must be calculated. Threading length can be increased to achieve 100% bending capacity of the intact casing. Designer in Responsible Charge can refer to the research paper "*Bending Strength of Threaded Micropile Connections*" by Steven R. Musselman, J.H. Long, N. Carroll, and S. Farr for methods to predict joint strength and stiffness.

See [Example 4.1 – Bending Strength of Threaded Micropile Connections](#).

One of the most significant disadvantages of slurry wall construction is the extensive field setup required. The excavation and mixing/fill equipment need to be located at each ends of the



excavated trench, with this setup equipment may foul the tracks when the slurry wall is in Zone 2. Therefore, the use of slurry wall is prohibited in Zone 2. Another disadvantage is that during the excavation before concrete can be placed, only bentonite slurry is used to support the adjacent soil to prevent the collapse of the trench. It may not support the lateral pressure from the Rapid Transit surcharge. Therefore, when slurry walls are used, the walls should be installed without trains. Considering the ballasted on-grade track North Main Line operates 24 hours every day, the use of slurry wall is considered not feasible unless a weekend shutdown is allowed.



SECTION 5 LOADING ON TEMPORARY SHORING SYSTEM COMMENTARY

C5.2 SOIL LOADS

C5.2.1 Soil Types and the Determination of Soil Properties⁸

Per ASTM D2573-08 Standard Test Method for Field Vane Shear Test in Saturated Fine-Grained Soils, Section 11 does not provide test data precision due to the nature of the test method. Section 5.3 also requires the peak undrained shear resistance of the vane test is commonly corrected to determine the undrained shear strength for geotechnical analysis. The agency requesting the testing must interpret these data to determine applicability for strength analysis. The undrained shear strength is commonly adjusted with liquid limit.

C5.2.2 Loading from Retained Soil on Flexible System^{9, 10, 11}

The value of 30 psf/ft is based on AREMA *Manual for Railway Engineering* Chapter 8 – Concrete Structures and Foundations Part 28 Temporary Structures for Construction Figure 8-28-2. The apparent earth pressure diagram shows the representative value of F is 28 - 36 psf/ft for soft clay. The lower bound value of 30 psf/ft is selected to represent the minimum soil pressure. This is also consistent with the AASHTO minimum soil pressure with a minimum 0.25 active pressure coefficient. Assuming a soil unit weight of 120 pcf – $0.25(120) = 30$ psf/ft.

AREMA *Manual for Railway Engineering* Table 8-5-1 specifies Type 3 backfill to be “fine silty sand; granular materials with conspicuous clay content; or residual soil with stones.” Even though this is not the typical soil profile in Chicago area (Chicago area is usually Type 4 soft or very soft clay, organic silt; or soft silty clay with little cohesion). Per AREMA *Manual for Railway Engineering* Table 8-5-2, Type 3 backfill material is specified to have unit weight of 125 lb. per cu. ft. and 28 degree of internal friction which yields 0.36 active pressure coefficient. This is considered conservative for retained soil.

C5.2.3 Loading from Retained Soil on Flexible System¹²

Per AREMA *Manual for Railway Engineering* Chapter 8 – Concrete Structures and Foundations Part 28 Temporary Structures for Construction Article 28.5.4.3 a (2), for masses which do not have a history of sliding, the magnitude of lateral pressures on multi-tiered anchored walls shall be computed following the guidelines on Figure 8-28-2.

C5.2.4 Passive Pressure¹⁴

Rankine’s Theory does not account for wall friction and can be overly conservative when wall interface friction angle (δ) becomes greater. Especially when the ratio of wall interface friction angle (δ) over soil friction angle (Φ) exceeds $2/3$. However, Rankine’s Theory simplifies calculations and is generally used in the industry when calculating passive pressure.

Log-spiral theory accounts for the angle of wall friction and assumes either a curved or composite rupture line. Log-spiral theory provides a more realistic failure surface and yields a



higher passive resistance coefficient. However, this is recommended only when there are underground constrains.

Coulomb’s theory “determines the passive earth pressure force accounts for the angle of wall friction, the theory assumes a linear failure surface. The result is an error in Coulomb’s calculated force due to the fact that the actual sliding surface is curved rather than planar. Coulomb’s theory gives increasingly erroneous values of passive earth pressure as the wall friction increases. Therefore, Coulomb’s theory could lead to unsafe shoring system designs because the calculated value of passive earth pressure would become higher than the soil could generate.”⁴³

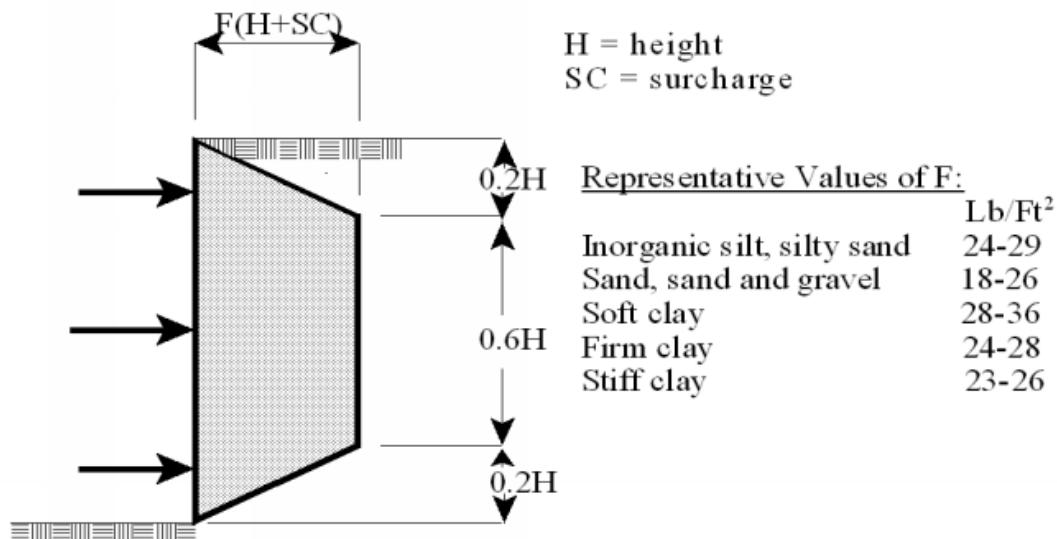

Figure 8-28-2. Apparent Earth Pressure Diagram

⁴³From Section 4.7 on Pages 4-50 and 4-51 in “Trenching and Shoring Manual” by State of California, Department of Transportation, Issued by Offices of Structure Construction, Copyright © 2011 California Department of Transportation. All rights reserved.



SECTION 6 RAPID TRANSIT LIVE LOAD SURCHARGE COMMENTARY

C6.1 GENERAL^{15, 16, 17}

It is CTA’s policy that the latest CTA Rapid Transit Live Load Diagrams are Sensitive Security Information that are controlled under 49 CFR PARTS 15 AND 1520. These diagrams or no part of these diagrams may be disclosed to persons without a “need to know” basis, as defined in CFR PARTS 15 AND 1520, except with the written permission of the administrator of the Transportation Security Administration or the Secretary of Transportation. Therefore, for CTA Rapid Transit Live Load the calculated strip loads are presented in the Manual. These strip loads were obtained with the following equation conservatively:

$$q = \frac{\max(Axle\ Load)}{\min(Axle\ Spacing) \cdot (Tie\ Length)}$$

However, users of this Manual can refer to AREMA *Manual for Railway Engineering* Volume 3 Chapter 12 – Rail Transit Part 4 – Facilities and Structural Considerations for general information, in which Figure 12-4-4 Live Loads Questionnaire, Attachment 3 contains information on the old version of CTA Design Axle Loads and Spacing.

For existing retaining walls supporting CTA tracks built prior to 1970, the design code used was either unclear to CTA Engineering, or may be the outdated AREA code where an older version of the Boussinesq lateral surcharge equation. If the Adjacent Construction Contractor and/or ERS Engineer in Responsible Charge submit the Variance Request with calculations showing factors of safety cannot be achieved, the following surcharge load reductions may be permitted, provided CTA Engineering can verify the period when the retaining walls in question was designed or constructed.

Reduced Strip load q for CTA Rapid Transit Axle Loads – Stability on Existing Retaining Walls:

$$q_{stability} = 397psf$$

If with the reduced transit surcharge live load the factor of safety still cannot achieve the requirements in SECTION 7, it is permitted that the modification factor be reduced to 1.5 in the Boussinesq equation as shown in Figure 6 - 1 and as shown below:

$$p_{s_modified} = \frac{1.5q}{\pi} (\beta + \sin\beta \sin^2\alpha - \sin\beta \cos^2\alpha)$$

C6.2 SURCHARGE FROM MULTIPLE TRACKS¹⁸

For example, track 3 surcharge needs not be included for the shoring wall design when the excavation is outside the Zone of Influence Line as defined per Figure 3 - 1.

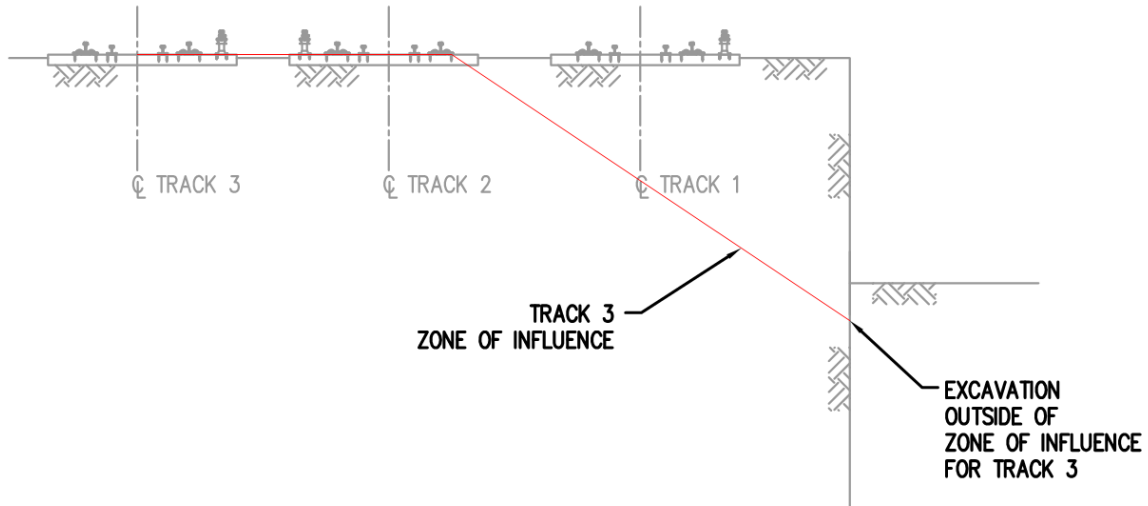



SECTION 7 SHORING ANALYSIS METHODOLOGIES COMMENTARY

C7.2 SOLDIER PILE SHORING WALLS¹⁹

In non-railroad application, it is industrial standard to only apply the effective width to passive pressure while active pressure can be treated acting only on the flange width or the diameter of concrete-filled hole. This may be considered to be acceptable in Zone 4 in the Zone of Influence **Figure 3 - 1**.

C7.3 ANALYSIS OF CANTILEVER WALLS^{20, 21, 22}

The 20 percent increase is not a factor of safety since it accounts for the unconservativeness with the “simplified” method for ignoring rotation of the length of vertical wall element.

The overall stability factor of safety shall be 2 for cantilever walls and this is achieved by dividing the passive resistance by 2 for stability check. Some guidelines such as NAVFAC_DM_02 Figure 23 shows “increase D by 20% - 40% to result in approximate factory of safety of 1.5 to 2”. Therefore, increase the theoretical embedment depth by 40% will be accepted for simple calculations.

AREMA *Manual for Railway Engineering* Chapter 8 Article 28.5.1.2 (b) acknowledges this concern and requires “depth of embedment increased to not less than the height of the wall” for “conditions such as unrealistically short penetration requirements into relatively strong layers”. This requirement has been adopted in this Manual.

C7.5 ANALYSIS OF WALLS WITH MULTIPLE LEVELS OF BRACING

C7.5.2 Analysis of Shoring Walls²³

Some agencies allow moment to be reduced to 80% of their computed values for design to account for wall continuity over the bracing locations. CTA Engineering agrees with this observation, however, since the shoring wall will be analyzed in a way that all bracing locations to be hinges except the uppermost, positive moments between the bracing locations generally govern the shoring wall design. Therefore, this Manual does not mention the 80% reduction to the calculated moment.

C7.8 GENERAL SHORING REQUIREMENTS

C7.8.1 Minimum Embedment Depth²⁴

South California Regional Rail Authority (SCRRA) Metrolink Excavation Support Guidelines, July 2009 requires minimum embedment depth for braced wall and these requirements have been adopted in this Manual.

C7.8.2 Secondary Bracing²⁵



AREMA *Manual for Railway Engineering* Chapter 15 Article 1.11.6 requires “bracing members used only as ties or struts, to reduce the unsupported length of a member to which they connect, need not be designed for more than 2.5% of the force in that member”.

C7.9 SHORING DEFLECTION AND SETTLEMENT^{26, 27}

CTA Engineering understands if including all deflections for each individual element of the shoring wall system, it is very difficult to satisfy the shoring wall deflection and vertical movement of the track limitations specified in [Section 10.2](#). However, this is a practical concern that many times is ignored when estimating the shoring wall deflection and settlement. It is the intent of CTA Engineering to ensure the Adjacent Construction Engineer in Responsible Charge and Contractor know the risks associated with construction and excavation adjacent to an active rapid transit track especially when the shoring walls are in Zone 2 and Zone 3. However, an economical design can still be achieved if track settlement is monitored and controlled in between the shoring wall installation stages. More detailed monitoring requirements are outlined in [Section 10](#).

Deflection limits in Zone 4 as shown in this Section is based on Metra Temporary Shoring Guidelines 10/1/2010 REV 0.



SECTION 8 MATERIAL PROPERTIES AND ALLOWABLE STRESSES COMMENTARY

C8.1 STEEL

C8.1.1 Structural Steel²⁸

The 12 ksi axial stress limit is a rule-of-thumb base value based on previous experience, it also provides some factor of safety for the use of HSS shapes as compression member such as strut since AREMA *Manual for Railway Engineering* does not have allowable stress equation for HSS shapes. Users of this Manual can refer to [Design Example 8.2 – Pipe Strut Design](#) for more information.

C8.1.2 Steel Sheet Piling^{29, 30}

AREMA *Manual for Railway Engineering* Chapter 8 Article 28.5.1.4, a, (1) requires sheet pile section allowable stress to be 2/3 tensile yield strength for new steel. This is not adopted in this Manual because USS Steel Sheet Piling Design Manual recommends 65% of minimum yield point and some increase for temporary overstresses are generally permissible. In this Manual, the overstress allowance is not adopted either.

Because of the nature of cold-bending, the small bend radius at the interlocking joints is small and the thickness is reduced resulting very flexible interlocks. Therefore, a 10% section property reduction is required. In addition, cold-rolled sheet piling cannot prevent water infiltration without interlock sealant.

C8.1.4 Wire Rope Cable and Chain³¹

Based on previous experience, wire rope cable and chain are not allowed to use as main load path structural components or secondary load bracing for track structure shoring structures due to the concern tautness being difficult to maintain.

C8.1.6 Micropile Casing Pipe³²

All grades of ASTM A500 structural steel pipe are considered exceeding ASTM A252 Grade 2.

The wall thickness reduction for ASTM A252 and ASTM A500 casing pipes are based on AISC Specification 360-10 Article B4.2, where for electric-resistance-welded (ERW) HSS design wall thickness shall be taken equal to 0.93 times the nominal wall thickness, and equal to the nominal thickness for submerged-arc-welded (SAW) HSS. Considering the material quality for temporary shoring wall may be difficult to control, the reduced wall thickness requirement will apply regardless the welding process used to manufacture the HSS.

C8.2 CONCRETE³³

The Load Factor Design in AREMA *Manual for Railway Engineering* was developed based on ACI 318, 1999 version, in which the load factors are higher than the modern ACI 318 Strength Design Method. Reinforced and plain (unreinforced) concrete may also be designed using the



Strength Design Method in accordance with the newer ACI 318 provided load combinations and load factors are in accordance with Table 8-2-5 AREMA *Manual for Railway Engineering* for Load Factor Design.



SECTION 9 SPECIAL CONDITIONS COMMENTARY

C9.3 BOTTOM STABILITY

C9.3.1 Piping³⁴

User of this Manual may refer to “*Trenching and Shoring Manual*” by State of California, Department of Transportation (Caltrans)⁴⁴ for additional information in regard to calculating the hydraulic forces in the condition of piping.

C9.4 GLOBAL STABILITY³⁵

When the excavation is outside the Zone of Influence or even the Basic Safety Envelope certain conditions exist where the global stability of tracks or structures can still be affected. As an example, this can occur when Adjacent Construction proposes to remove, even temporarily, a large structure that serves to provide stability to embankment structure/tracks. In this example, this may occur where the soil profile contains weak clay with sand, or other similar poor soil conditions. Global stability of the tracks will be affected and stability analysis needs to be performed to ensure existing tracks will not be affected. It is not practical or safe to expect CTA Engineering reviewers to provide directions on when a global stability analysis is warranted since CTA Engineering reviewers would not be familiar with the Adjacent Construction site, geotechnical soil profile and the scope of the work. Therefore, the Engineer in Responsible Charge must determine if global stability analysis is warranted.

⁴⁴“*Trenching and Shoring Manual*” by State of California, Department of Transportation, Issued by Offices of Structure Construction, Copyright © 2011 California Department of Transportation. All rights reserved.



SECTION 10 TRACK MONITORING COMMENTARY

C10.3 MINIMUM MONITORING REQUIREMENTS^{36, 37}

Based on various previous experience, more reliable survey data can be obtained by mounting the survey points (equipment) on the crossties, while handheld survey equipment set up on top of running rail in between trains may generate unreliable survey data.

Structural thermal expansion and contraction can affect the monitoring baseline readings. Therefore, it is recommended the baseline readings be averaged with all readings taken over a three-day period. If baseline readings are taken with more than three days, it may be more beneficial to the Contractor as 3-day rolling average readings can be permitted to be used with the highest value as the upper bound, and lowest value as the lower bound, as shown in below figure, especially for the Adjacent Construction Projects that require extensive construction time. A minimum of seven sets of baseline readings are required to construct a minimum of five rolling average readings.

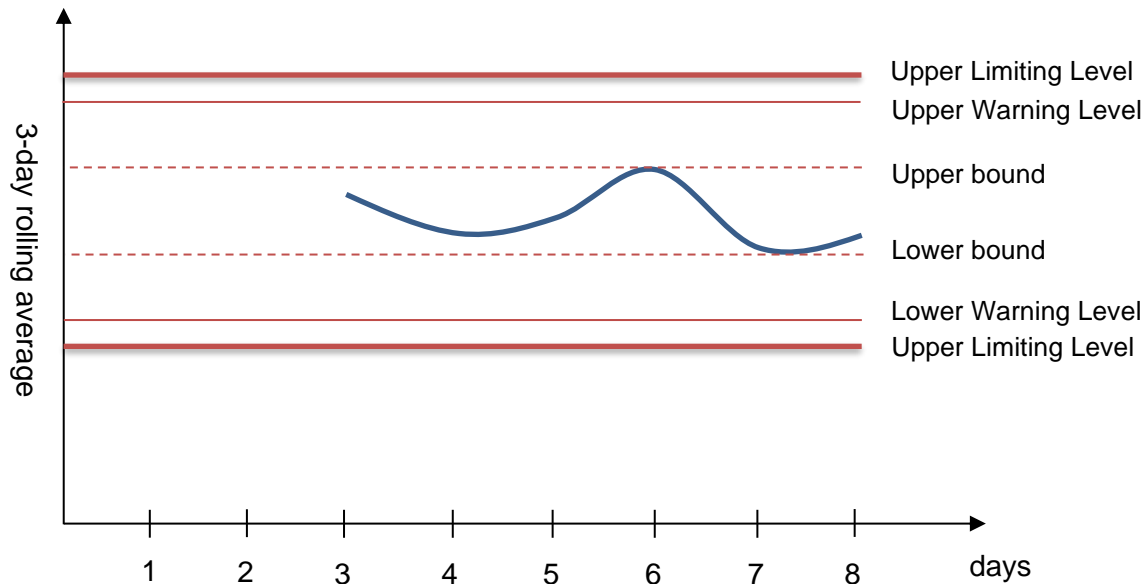



SECTION 11 OTHER TYPES OF ADJACENT CONSTRUCTION COMMENTARY

C11.1 CONSTRUCTION ADJACENT TO CTA UNDERGROUND STRUCTURES

C11.1.3 Tunnel Analysis Criteria³⁸

The assumption that all CTA underground structures are cut-and-cover is not true based on history references found. These references indicate that the subway tunnels in the loop were either bored, or constructed with compressed air temporarily supporting the tunnel construction, and this type of construction should be considered as bored. Adjacent Construction that requires excavation and exposing large portion of CTA subway structures is rare, and even less likely being inside the loop. If new construction is adjacent to or over existing CTA bored tunnels, as directed by CTA, provide an analysis of the tunnel support system (liner) for the changed loading condition due to the adjacent construction. The analysis shall follow requirements outlined in Section 11.1.3 and include uplift of tunnel when excavation is over CTA bored underground structures.

C11.1.4 Augered, Driven and Vibrated Penetration Construction Protocol³⁹

CTA Red Line State Street underground structures have been recently surveyed with relatively more accurate survey data, therefore probing may not be required.

C11.3 CONSTRUCTION ADJACENT TO CTA ELEVATED TRACK STRUCTURES

C11.3.2 Excavation Shoring Required⁴⁰

Per AREMA *Manual for Railway Engineering* Chapter 8 Part 3 Article 3.4.2, for the allowable bearing pressure, the safety factor for primary loads shall not be less than 3. For primary and secondary loads, the safety factor shall not be less than 2. A primary function for a tower bent is to resist lateral and longitudinal forces and the footing bearing pressure may be greater than the typical spans. Therefore, it is required to have the allowable bearing pressure time $3/2 = 1.5$ for the shoring wall design to account for all the secondary loads.

C11.4 ELEVATED TRACK STRUCTURE TEMPORARY SHORING⁴²

As discussed in the Manual, directly shoring of the elevated track structures is prohibited for Adjacent Construction Projects, unless otherwise permitted by the CTA in writing when no alternate is practical. All requirements associated with this type of work are covered in the CTA Infrastructure Design Criteria Manual (IDCM) Chapter 7 – Structural, and CTA's Specifications for track structural shoring and monitoring. The CTA Specifications that govern the work are:

- 31 15 00 – Structural Shoring



- 31 50 00 – Geotechnical Structural Monitoring Instrumentation, and,
- All related sections included

In an effort not to duplicate information, the Manual refers to the above-mentioned references for the design, construction, and monitoring for direct shoring of elevated track structures. With the same reason, the monitoring requirements for Earth Retention Structures are in the Manual and all CTA Specifications refer to the Manual.



APPENDIX G – PRE-APPROVED WORK AREA-TRACK SEPARATION FENCE

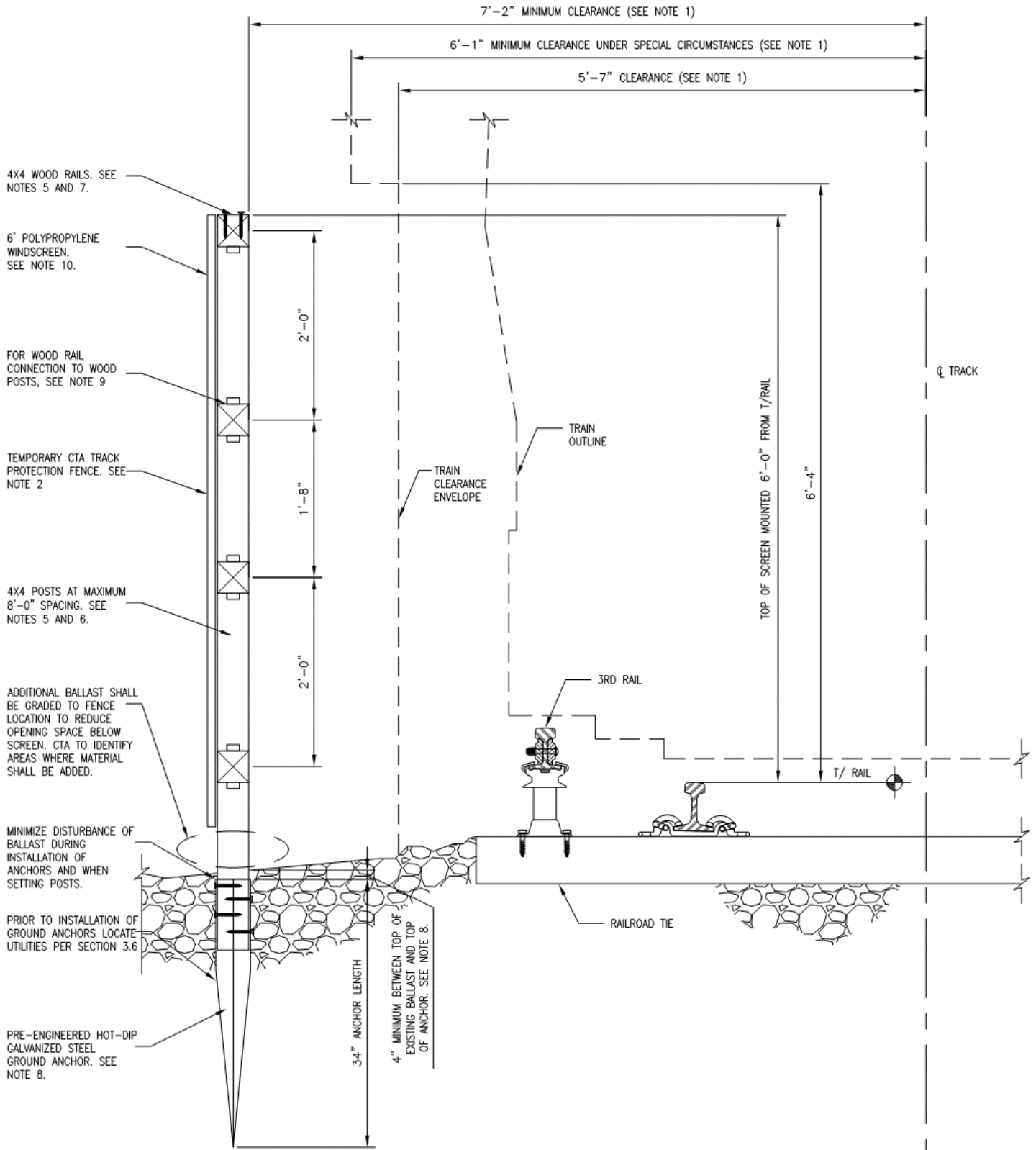



Notes:

1. Horizontal clearances less than 7'-2" can be allowed under special permission from the CTA. Section 4-5.3 in CTA's Safety Manual contains additional information and may be provided by Safety Department after reviewing the CPP. See Appendix B for train clearance envelope.
2. Temporary CTA track protection fence is designed to resist a horizontal wind pressure of not less than 30 pounds per square foot or a simultaneous vertical and horizontal thrust of 50 pounds per linear foot applied to each rail or a simultaneous vertical and horizontal concentrated load of 200 pounds in any direction applied to each rail, whichever loading produced the greatest stress.
3. Temporary CTA track protection fence layout and installation process plan shall be submitted for cta review and approval prior to start of installation. All procedures for installation must meet the requirements of the CTA flagging and coordination special provision and associated CTA procedures.
4. Submit shop drawings including, but not limited to, product and material certificates for all products and materials used prior to start of installation.
5. Wood shall be pressure treated and per [Section 8.3](#).
6. Wood post size shall be 4" x 4" spaced a maximum of 8 feet on center, length of post may vary to maintain top of fence at minimum height above top of rail.
7. Wood rail size shall be minimum 4" x 4" spaced a maximum 24" center to center.
8. To minimize disturbance of the ballast and subgrade along the tracks, support 4" x 4" posts with pre-engineered hot-dip galvanized steel ground anchors, model t4-850, 34" long, as manufactured by Oz-post, Richardson, Texas or approved equal.
 - a. Submit certifications and independent load tests from manufacturer that post anchors, used with posts specified in note 5, are capable of resisting a minimum 120 miles per hour wind load for a minimum of 5 minutes.
 - b. Install wood posts to galvanized steel post anchors and install post anchors in ground in accordance with manufacturer's instructions. Using equipment and connectors as recommended by manufacturer of post anchor, unless otherwise specified.
 - c. The top of the steel ground anchors shall be set a minimum of 4" below existing ballast grade and backfilled to match existing adjacent area. The bury depth shall be evaluated and adjusted based on load tests performed by the contractor and certified by an independent testing firm licensed in the state of Illinois. Submit load test procedure and results sealed and signed by the testing firm's Illinois registered professional engineer. Load tests will not be paid for separately.



- d. A mock-up post installation shall be built and load test conducted to evaluate the adequacy of the bury depth shown on this drawing. The mock-up shall be installed in an area where the post and steel ground anchor can be load tested. A load of 1300 pounds shall be applied to the post at the ground level. The deflection at the top of the post shall be measured.
 - e. If the ground anchor shifts out of position or the post deflects greater than 1 inch at the top, a mock-up installation and load test shall be repeated with the distance between the existing ballast grade to the top of the ground anchor increased incrementally until the load test results in a successful test that meets the required deflection criteria. The steel ground anchors for all fence posts shall be installed at the bury depth that meets the required deflection criteria.
9. Wood rail to wood post connections shall be made with hot-dip galvanized or stainless steel nails or hot-dip galvanized or stainless steel framing angles manufactured by Simpson strong-tie company, Columbus, Ohio or approved equal, for use with pressure treated wood. Galvanizing shall conform to ASTM A653, G185 coating protection or greater. Wood rail to post connections shall be horizontally. Use four (4) 30d sinker nails to toenail wood rails to wood posts, two (2) top and two (2) bottom of rails or two (2) a34 framing angles one (1) top and one (1) bottom of rails as manufactured by Simpson strong-tie company, or approved equal.
 10. Windscreen as manufactured by Carron net co. Inc., Two Rivers, Wisconsin or approved equal shall be 6 feet high, with sections a minimum of 8 feet long, open mesh, 75% opening, vinyl coated dark green polypropylene (weight - 1 lb per 21 sq ft of material) with edges reinforced with 1" herculite vinyl material and heavy duty solid brass grommets located at 18 inches on center on all 4 sides and at 18 inches on center horizontally at each rail for attachment to intermediate fence rails spaced to match rail spacing. Attach windscreen to wood posts and rails with heavy duty plastic zip ties placed through the grommets and around the posts and rails. The heavy-duty plastic zip ties shall be rated for a minimum tensile strength of 175 pounds. Length of the ties shall be as required to securely fasten the windscreen taught around the wood posts and rails. Submit manufacturer's certification for the zip ties and windscreen. Install wind screen per manufacturer's recommendations.
 11. Any proposed Contractor changes shall be submitted for review to engineer and CTA, with calculations and drawings sealed and signed by an Illinois licensed Structural Engineer employed by the Contractor. Review and comment by engineer and CTA shall not relieve the Contractor of his responsibility for the design of any modifications proposed by the Contractor.
 12. All maintenance of the fence prior to removal is the responsibility of the Contractor, the fence shall remain in the same horizontal and vertical position, with the windscreen remaining secure to the rails and posts. The Engineer will alert the Contractor to any issues that require immediate attention.



13. After the need for the temporary CTA track protection fence is complete, all components of the fence installation shall be completely removed, including the ground anchors. Contractor shall submit removal plan to the engineer and CTA for approval prior to the execution of the removal work. All items shall be disposed of properly, or retained by the Contractor. The ground along the fence installation shall be restored to pre-existing conditions and to the satisfaction of the engineer and the CTA.



APPENDIX H – VARIANCE REQUEST FORM

At a minimum, the information in the following form must be submitted for CTA’s review of variance requests. Part 1 and 2 must be filled in by the requestor.

Part 1 - Adjacent Construction Manual Variance Request	
Project Name	
Location Description	[include OUC when available] – [adjacent CTA infrastructure] – [project address]
Date	
Originator of Request	<i>Name:</i>
	<i>Title:</i>
	<i>Company:</i> [include contact information]
	<i>Signature:</i>
Part 2 - Variance Request Background Data	
Impacts	Does this Variance impact Safety and Operations? <input type="checkbox"/> Yes <input type="checkbox"/> No
	Does this Variance conflict with any IDOT/CDOT regulations and requirements? <input type="checkbox"/> Yes <input type="checkbox"/> No
Variance Information	<i>Does this variance affect the following?</i> This Manual <input type="checkbox"/> Yes <input type="checkbox"/> No Safety <input type="checkbox"/> Yes <input type="checkbox"/> No
	<i>Description of Variance:</i> [include specific section/citations of adjacent construction manual]
	<i>Mitigation Measures:</i>



Reason for Request	<i>Design Variance must address the following:</i> <ul style="list-style-type: none">• Manual criteria versus proposed• Reason the appropriate design criteria cannot be met• Justification for the proposed Criteria• Any background information which documents, support, or justification for the request• Any mitigation that will be provided to further support or justify the request• Safety implication of the request• The comparative cost of the full standard versus the lower design being proposed. Show what it would cost to meet the standard for which the Variance is requested.• Long term effect of the reduced design as compared to the full standard
Attachments	[The completed CTA Variance Request Form and all supporting documentation (drawings, reports, and calculations) shall be submitted with all requests for Variances. This form and all documentation attached with the request must be stamped and sealed by a Licensed Structural Engineer Registered in the State of Illinois.]

Part 3 - CTA Disposition

Approved? Yes No

Chief Engineer, Infrastructure

Date